



### FEATURES

#### Rail-to-rail input/output

Low power: 0.625 mA typical per amplifier at  $\pm 15$  V

Gain bandwidth product: 15.9 MHz at  $A_v = 100$  typical

Unity-gain crossover: 9.9 MHz typical

-3 dB closed-loop bandwidth: 13.9 MHz typical at  $\pm 15$  V

Low offset voltage: 100  $\mu$ V maximum (SOIC)

Unity-gain stable

High slew rate: 4.6 V/ $\mu$ s typical

Low noise: 3.9 nV/ $\sqrt{\text{Hz}}$  typical at 1 kHz

### APPLICATIONS

Battery-powered instrumentation

High-side and low-side sensing

Power supply control and protection

Telecommunications

Digital-to-analog converter (DAC) output amplifiers

Analog-to-digital converter (ADC) input buffers

### GENERAL DESCRIPTION

The ADA4084-1 (single), ADA4084-2 (dual), and ADA4084-4 (quad) are single-supply, 10 MHz bandwidth amplifiers featuring rail-to-rail inputs and outputs. They are guaranteed to operate from +3 V to +30 V (or  $\pm 1.5$  V to  $\pm 15$  V).

These amplifiers are well suited for single-supply applications requiring both ac and precision dc performance. The combination of wide bandwidth, low noise, and precision makes the ADA4084-1, ADA4084-2, and ADA4084-4 useful in a wide variety of applications, including filters and instrumentation.

Other applications for these amplifiers include portable telecommunications equipment, power supply control and protection, and use as amplifiers or buffers for transducers with wide output ranges. Sensors requiring a rail-to-rail input amplifier include Hall effect, piezoelectric, and resistive transducers.

The ability to swing rail to rail at both the input and output enables designers to build multistage filters in single-supply systems and to maintain high signal-to-noise ratios.

The ADA4084-1, ADA4084-2, and ADA4084-4 are specified over the industrial temperature range of  $-40^\circ\text{C}$  to  $+125^\circ\text{C}$ .

### PIN CONNECTION DIAGRAM

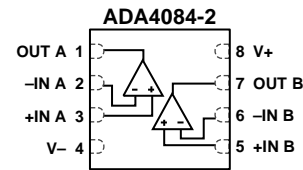

NOTES  
1. FOR THE LFCSP PACKAGE, THE EXPOSED PAD MUST BE CONNECTED TO V-.

08237-001

Figure 1. ADA4084-2, 8-Lead LFCSP (CP)

See the Pin Configurations and Function Descriptions section for additional pin configurations and information about the pin functions.

The single ADA4084-1 is available in the 5-lead SOT-23 and 8-lead SOIC; the dual ADA4084-2 is available in the 8-lead SOIC, 8-lead MSOP, and 8-lead LFCSP surface-mount packages; and the ADA4084-4 is offered in the 14-lead TSSOP and 16-lead LFCSP.

The ADA4084-1, ADA4084-2, and ADA4084-4 are members of a growing series of high voltage, low noise op amps offered by Analog Devices, Inc. (see Table 1).

Table 1. Low Noise Op Amps

Single	Dual	Quad	Voltage Noise
AD8597	AD8599		1.1 nV/Hz
ADA4004-1	ADA4004-2	ADA4004-4	1.8 nV/Hz
AD8675	AD8676		2.8 nV/Hz rail-to-rail output
AD8671	AD8672	AD8674	2.8 nV/Hz
OP27, OP37			3.2 nV/Hz
ADA4084-1	ADA4084-2	ADA4084-4	3.9 nV/Hz rail-to-rail input/output

**TABLE OF CONTENTS**

Features .....	1	$\pm 5$ V Characteristics.....	17
Applications.....	1	$\pm 15$ V Characteristics .....	23
Pin Connection Diagram .....	1	Applications Information .....	29
General Description .....	1	Functional Description.....	29
Revision History .....	3	Start-Up Characteristics .....	30
Specifications.....	4	Input Protection .....	30
Electrical Characteristics .....	4	Output Phase Reversal.....	30
Absolute Maximum Ratings.....	7	Designing Low Noise Circuits in Single-Supply Applications ..	31
Thermal Resistance .....	7	Comparator Operation.....	31
ESD Caution.....	7	Outline Dimensions .....	32
Pin Configurations and Function Descriptions .....	8	Ordering Guide .....	35
Typical Performance Characteristics .....	11		
$\pm 1.5$ V Characteristics.....	11		

**REVISION HISTORY****8/15—Rev. G to Rev. H**

Added 5-Lead SOT-23 .....	Universal
Changes to Pin Connection Diagram Section, Figure 1, and General Description Section .....	1
Deleted Figure 3; Renumbered Sequentially .....	1
Changes to Large Signal Voltage Gain Parameter, Table 2 .....	4
Changes to Large Signal Voltage Gain Parameter, Table 3 .....	5
Changes to Large Signal Voltage Gain Parameter, Table 4 .....	6
Changes to Table 6 .....	7
Moved Figure 3 .....	8
Added Pin Configurations and Function Descriptions Section, Figure 4, Figure 5, Table 7, Table 8, and Table 9; Renumbered Sequentially .....	8
Added Figure 6, Figure 7, Figure 8, Table 10, and Table 11 .....	9
Moved Figure 9 .....	10
Added Table 12 .....	10
Added Figure 11 and Figure 15 .....	11
Added Figure 42 and Figure 46 .....	17
Added Figure 73 and Figure 77 .....	23
Updated Outline Dimensions .....	32
Changes to Ordering Guide .....	35

**6/15—Rev. F to Rev. G**

Changes to Figure 96 and Figure 97 .....	24
--	----

**1/15—Rev. E to Rev. F**

Moved Revision History .....	3
Changes to Table 5 .....	7
Changes to Ordering Guide .....	29

**7/14—Rev. D to Rev. E**

Added ADA4084-1 .....	Universal
Added Figure 1; Renumbered Sequentially .....	1
Changes to Output Voltage High Parameter, Table 2 .....	3
Changes to Current Noise Density Parameter, Table 3 .....	4
Changes to Current Noise Density Parameter, Table 4 .....	5
Changes to Figure 8 Caption, and Figure 9 to Figure 11 .....	7
Changes to Figure 13 .....	8
Changes to Figure 21 .....	9
Added Figure 31; Renumbered Sequentially .....	11
Changes to Figure 30 Caption, and Figure 32 to Figure 34 .....	11
Changes to Figure 36 Caption to Figure 39 Caption .....	12
Changes to Figure 50 .....	14
Added Figure 60 .....	16
Changes to Figure 59 Caption, Figure 62, and Figure 63 .....	16
Changes to Figure 65 Caption to Figure 68 Caption .....	17
Changes to Figure 79 .....	19
Added Figure 89 .....	21
Changes to Figure 88 Caption, Figure 91 Caption, and Figure 92 Caption .....	21
Changes to Ordering Guide .....	28

**11/13—Rev. C to Rev. D**

Added 14-Lead TSSOP and 16-Lead LFCSP Packages .....	Universal
Added ADA4084-4 .....	Universal
Change to Features Section and Applications Section .....	1
Added Figure 2 and Figure 3; Renumbered Sequentially .....	1
Changes to Table 2 .....	3
Changes to Table 3 .....	4
Changes to Table 4 .....	5
Changes to Table 5 and Table 6 .....	6
Changes to Typical Performance Characteristics Section .....	7
Updated Outline Dimensions .....	27
Changes to Ordering Guide .....	28

**4/13—Rev. B to Rev. C**

Changes to Figure 48 Caption .....	15
Updated Outline Dimensions .....	25

**6/12—Rev. A to Rev. B**

Added LFCSP Package .....	Universal
Changes to Figure 1 .....	1
Changes to Output Voltage High Parameter, Table 4 .....	5
Added Figure 5 and Figure 7, Renumbered Sequentially .....	7
Added Figure 30 and Figure 32 .....	12
Added Figure 55 and Figure 57 .....	17
Added Startup Characteristics Section .....	23
Moved Figure 78 .....	23
Changes to Output Phase Reversal Section and Comparator Operation Section .....	24
Updated Outline Dimensions .....	25
Changes to Ordering Guide .....	26

**2/12—Rev. 0 to Rev. A**

Changes to Data Sheet Title .....	1
Changes to Voltage Range in General Description .....	1
Changes to Supply Current/Amplifier Parameter, Table 2 .....	3
Changes to Common-Mode Rejection Ratio Parameter, Table 3 ..	4
Changes to Common-Mode Rejection Ratio Parameter, Table 4 ..	5
Changes to Figure 2 .....	6
Changes to Figure 24 .....	10
Changes to Figure 32 .....	12
Changes to Figure 47 .....	14
Changes to Figure 55 .....	16
Changes to Figure 62 .....	17
Changes to Figure 73 .....	20

**10/11—Revision 0: Initial Version**

# SPECIFICATIONS

## ELECTRICAL CHARACTERISTICS

$V_{SY} = 3\text{ V}$ ,  $V_{CM} = 1.5\text{ V}$ ,  $T_A = 25^\circ\text{C}$ , unless otherwise noted.

Table 2.

Parameter	Symbol	Test Conditions/Comments	Min	Typ	Max	Unit
<b>INPUT CHARACTERISTICS</b>						
Offset Voltage	$V_{OS}$	SOIC package		20	100	$\mu\text{V}$
		$-40^\circ\text{C} \leq T_A \leq +125^\circ\text{C}$			200	$\mu\text{V}$
		SOT-23, MSOP, TSSOP packages		50	130	$\mu\text{V}$
		$-40^\circ\text{C} \leq T_A \leq +125^\circ\text{C}$			250	$\mu\text{V}$
		ADA4084-2 LFCSP package		80	200	$\mu\text{V}$
Offset Voltage Drift	$\Delta t/\Delta T$	$-40^\circ\text{C} \leq T_A \leq +125^\circ\text{C}$		0.5	1.75	$\mu\text{V}/^\circ\text{C}$
		$-40^\circ\text{C} \leq T_A \leq +125^\circ\text{C}$				
Offset Voltage Matching		$T_A = 25^\circ\text{C}$			150	$\mu\text{V}$
Input Bias Current	$I_B$	ADA4084-4 LFCSP package			200	$\mu\text{V}$
		$-40^\circ\text{C} \leq T_A \leq +125^\circ\text{C}$		140	250	nA
Input Offset Current	$I_{OS}$	$-40^\circ\text{C} \leq T_A \leq +125^\circ\text{C}$			400	nA
		$-40^\circ\text{C} \leq T_A \leq +125^\circ\text{C}$		5	25	nA
Input Voltage Range	CMRR	$-40^\circ\text{C} \leq T_A \leq +125^\circ\text{C}$			50	nA
		$V_{CM} = 0\text{ V to }3\text{ V}$	0		3	V
Common-Mode Rejection Ratio	CMRR	$-40^\circ\text{C} \leq T_A \leq +125^\circ\text{C}$	64	88		dB
		$R_L = 2\text{ k}\Omega$ , $0.5\text{ V} \leq V_{OUT} \leq 2.5\text{ V}$	60			dB
Large Signal Voltage Gain	$A_{VO}$	$-40^\circ\text{C} \leq T_A \leq +125^\circ\text{C}$	100	104		dB
		$-40^\circ\text{C} \leq T_A \leq +125^\circ\text{C}$	97			dB
Input Impedance		Differential		100  1.1		k $\Omega$   pF
		Common Mode		80  2.9		M $\Omega$   pF
<b>OUTPUT CHARACTERISTICS</b>						
Output Voltage High	$V_{OH}$	$R_L = 10\text{ k}\Omega$ to $V_{CM}$	2.90	2.95		V
		$-40^\circ\text{C} \leq T_A \leq +125^\circ\text{C}$	2.80			V
		$R_L = 2\text{ k}\Omega$ to $V_{CM}$	2.85	2.9		V
		$-40^\circ\text{C} \leq T_A \leq +125^\circ\text{C}$	2.70			V
Output Voltage Low	$V_{OL}$	$R_L = 10\text{ k}\Omega$ to $V_{CM}$		10	20	mV
		$-40^\circ\text{C} \leq T_A \leq +125^\circ\text{C}$			40	mV
		$R_L = 2\text{ k}\Omega$ to $V_{CM}$		20	30	mV
		$-40^\circ\text{C} \leq T_A \leq +125^\circ\text{C}$			50	mV
Short-Circuit Current	$I_{SC}$			-17/+10		mA
Closed-Loop Output Impedance	$Z_{OUT}$	$f = 1\text{ kHz}$ , $A_V = 1$		0.1		$\Omega$
<b>POWER SUPPLY</b>						
Power Supply Rejection Ratio	PSRR	$V_{SY} = \pm 1.25\text{ V to } \pm 1.75\text{ V}$	100	110		dB
		$-40^\circ\text{C} \leq T_A \leq +125^\circ\text{C}$	90			dB
Supply Current per Amplifier	$I_{SY}$	$I_{OUT} = 0\text{ mA}$		0.565	0.650	mA
		$-40^\circ\text{C} \leq T_A \leq +125^\circ\text{C}$			0.950	mA
<b>DYNAMIC PERFORMANCE</b>						
Slew Rate	SR	$R_L = 2\text{ k}\Omega$	2.0	2.6		V/ $\mu\text{s}$
Gain Bandwidth Product	GBP	$V_{IN} = 5\text{ mV p-p}$ , $R_L = 10\text{ k}\Omega$ , $A_V = 100$		15.4		MHz
Unity-Gain Crossover	UGC	$V_{IN} = 5\text{ mV p-p}$ , $R_L = 10\text{ k}\Omega$ , $A_V = 1$		8.08		MHz
Phase Margin	$\Phi_M$			86		Degrees
-3 dB Closed-Loop Bandwidth	-3 dB	$A_V = 1$ , $V_{IN} = 5\text{ mV p-p}$		12.3		MHz
Settling Time	$t_S$	$A_V = 10$ , $V_{IN} = 2\text{ V p-p}$ , 0.1%		4		$\mu\text{s}$
Total Harmonic Distortion Plus Noise	THD + N	$V_{IN} = 300\text{ mV rms}$ , $R_L = 2\text{ k}\Omega$ , $f = 1\text{ kHz}$		0.009		%
<b>NOISE PERFORMANCE</b>						
Voltage Noise	$e_n$ p-p	0.1 Hz to 10 Hz		0.14		$\mu\text{V p-p}$
Voltage Noise Density	$e_n$	$f = 1\text{ kHz}$		3.9		nV/ $\sqrt{\text{Hz}}$
Current Noise Density	$i_n$	$f = 1\text{ kHz}$		0.55		pA/ $\sqrt{\text{Hz}}$

$V_{SY} = \pm 5.0\text{ V}$ ,  $V_{CM} = 0\text{ V}$ ,  $T_A = 25^\circ\text{C}$ , unless otherwise noted.

Table 3.

Parameter	Symbol	Test Conditions/Comments	Min	Typ	Max	Unit	
INPUT CHARACTERISTICS							
Offset Voltage	$V_{OS}$	SOIC package		30	100	$\mu\text{V}$	
		$-40^\circ\text{C} \leq T_A \leq +125^\circ\text{C}$			200	$\mu\text{V}$	
		SOT-23, MSOP, TSSOP packages		60	130	$\mu\text{V}$	
		$-40^\circ\text{C} \leq T_A \leq +125^\circ\text{C}$			250	$\mu\text{V}$	
		ADA4084-2 LFCSP package		90	200	$\mu\text{V}$	
Offset Voltage Drift	$\Delta V_{OS}/\Delta T$	$-40^\circ\text{C} \leq T_A \leq +125^\circ\text{C}$		0.5	1.75	$\mu\text{V}/^\circ\text{C}$	
		$T_A = 25^\circ\text{C}$			150	$\mu\text{V}$	
Offset Voltage Matching		ADA4084-4 LFCSP package			200	$\mu\text{V}$	
Input Bias Current	$I_B$	$-40^\circ\text{C} \leq T_A \leq +125^\circ\text{C}$		140	250	nA	
Input Offset Current	$I_{OS}$	$-40^\circ\text{C} \leq T_A \leq +125^\circ\text{C}$		5	25	nA	
		$-40^\circ\text{C} \leq T_A \leq +125^\circ\text{C}$			50	nA	
Input Voltage Range			-5		+5	V	
Common-Mode Rejection Ratio	CMRR	$V_{CM} = \pm 4\text{ V}$ , $-40^\circ\text{C} \leq T_A \leq +125^\circ\text{C}$	106	124		dB	
		$V_{CM} = \pm 5\text{ V}$				76	dB
		$V_{CM} = \pm 5\text{ V}$ , $-40^\circ\text{C} \leq T_A \leq +125^\circ\text{C}$				70	dB
Large Signal Voltage Gain	$A_{VO}$	$R_L = 2\text{ k}\Omega$ , $-4\text{ V} \leq V_{OUT} \leq 4\text{ V}$	108	112		dB	
		$-40^\circ\text{C} \leq T_A \leq +125^\circ\text{C}$				103	dB
Input Impedance							
Differential				100  1.1		k $\Omega$   pF	
Common Mode				200  2.5		M $\Omega$   pF	
OUTPUT CHARACTERISTICS							
Output Voltage High	$V_{OH}$	$R_L = 10\text{ k}\Omega$ to $V_{CM}$	4.9	4.95		V	
		$-40^\circ\text{C} \leq T_A \leq +125^\circ\text{C}$				4.8	V
		$R_L = 2\text{ k}\Omega$ to $V_{CM}$	4.8	4.85			V
		$-40^\circ\text{C} \leq T_A \leq +125^\circ\text{C}$				4.7	V
Output Voltage Low	$V_{OL}$	$R_L = 10\text{ k}\Omega$ to $V_{CM}$		-4.95	-4.9	V	
		$-40^\circ\text{C} \leq T_A \leq +125^\circ\text{C}$				-4.8	V
		$R_L = 2\text{ k}\Omega$ to $V_{CM}$		-4.95	-4.8		V
		$-40^\circ\text{C} \leq T_A \leq +125^\circ\text{C}$				-4.7	V
Short-Circuit Current	$I_{SC}$		-24/+17			mA	
Closed-Loop Output Impedance	$Z_{OUT}$	$f = 1\text{ kHz}$ , $A_V = 1$		0.1		$\Omega$	
POWER SUPPLY							
Power Supply Rejection Ratio	PSRR	$V_{SY} = \pm 2\text{ V}$ to $\pm 18\text{ V}$	110	120		dB	
		$-40^\circ\text{C} \leq T_A \leq +125^\circ\text{C}$				105	dB
Supply Current per Amplifier	$I_{SY}$	$I_{OUT} = 0\text{ mA}$		0.595	0.700	mA	
		$-40^\circ\text{C} \leq T_A \leq +125^\circ\text{C}$			1.00	mA	
DYNAMIC PERFORMANCE							
Slew Rate	SR	$R_L = 2\text{ k}\Omega$ to $V_{CM}$	2.4	3.7		V/ $\mu\text{s}$	
Gain Bandwidth Product	GBP	$V_{IN} = 5\text{ mV p-p}$ , $R_L = 10\text{ k}\Omega$ , $A_V = 100$		15.9		MHz	
Unity-Gain Crossover	UGC	$V_{IN} = 5\text{ mV p-p}$ , $R_L = 10\text{ k}\Omega$ , $A_V = 1$		9.6		MHz	
Phase Margin	$\Phi_M$			85		Degrees	
-3 dB Closed-Loop Bandwidth	-3 dB	$A_V = 1$ , $V_{IN} = 5\text{ mV p-p}$		13.9		MHz	
Settling Time	$t_s$	$A_V = 10$ , $V_{IN} = 8\text{ V p-p}$ , 0.1%		4		$\mu\text{s}$	
Total Harmonic Distortion Plus Noise	THD + N	$V_{IN} = 2\text{ V rms}$ , $R_L = 2\text{ k}\Omega$ , $f = 1\text{ kHz}$		0.003		%	
NOISE PERFORMANCE							
Voltage Noise	$e_n$ p-p	0.1 Hz to 10 Hz		0.14		$\mu\text{V p-p}$	
Voltage Noise Density	$e_n$	$f = 1\text{ kHz}$		3.9		nV/ $\sqrt{\text{Hz}}$	
Current Noise Density	$i_n$	$f = 1\text{ kHz}$		0.55		pA/ $\sqrt{\text{Hz}}$	

$V_{SY} = \pm 15.0\text{ V}$ ,  $V_{CM} = 0\text{ V}$ ,  $T_A = 25^\circ\text{C}$ , unless otherwise noted.

Table 4.

Parameter	Symbol	Test Conditions/Comments	Min	Typ	Max	Unit
<b>INPUT CHARACTERISTICS</b>						
Offset Voltage	$V_{OS}$	SOIC package		40	100	$\mu\text{V}$
		$-40^\circ\text{C} \leq T_A \leq +125^\circ\text{C}$			200	$\mu\text{V}$
		SOT-23, MSOP, TSSOP packages		70	130	$\mu\text{V}$
		$-40^\circ\text{C} \leq T_A \leq +125^\circ\text{C}$			250	$\mu\text{V}$
		ADA4084-2 LFCSP package		100	200	$\mu\text{V}$
		$-40^\circ\text{C} \leq T_A \leq +125^\circ\text{C}$			300	$\mu\text{V}$
Offset Voltage Drift	$\Delta V_{OS}/\Delta T$			0.5	1.75	$\mu\text{V}/^\circ\text{C}$
Offset Voltage Matching		$T_A = 25^\circ\text{C}$			150	$\mu\text{V}$
		ADA4084-4 LFCSP package			200	$\mu\text{V}$
Input Bias Current	$I_B$			140	250	nA
		$-40^\circ\text{C} \leq T_A \leq +125^\circ\text{C}$			400	nA
Input Offset Current	$I_{OS}$			5	25	nA
		$-40^\circ\text{C} \leq T_A \leq +125^\circ\text{C}$			50	nA
Input Voltage Range			-15		+15	V
Common-Mode Rejection Ratio	CMRR	$V_{CM} = \pm 14\text{ V}$ , $-40^\circ\text{C} \leq T_A \leq +125^\circ\text{C}$	106	124		dB
		$V_{CM} = \pm 15\text{ V}$	85			dB
		$V_{CM} = \pm 15\text{ V}$ , $-40^\circ\text{C} \leq T_A \leq +125^\circ\text{C}$	80			dB
Large Signal Voltage Gain	$A_{VO}$	$R_L = 2\text{ k}\Omega$ , $-13.5\text{ V} \leq V_{OUT} \leq +13.5\text{ V}$	110	117		dB
		$-40^\circ\text{C} \leq T_A \leq +125^\circ\text{C}$	105			dB
Input Impedance						
Differential				100  1.1		k $\Omega$   pF
Common Mode				200  2.5		M $\Omega$   pF
<b>OUTPUT CHARACTERISTICS</b>						
Output Voltage High	$V_{OH}$	$R_L = 10\text{ k}\Omega$ to $V_{CM}$	14.85	14.9		V
		$-40^\circ\text{C} \leq T_A \leq +125^\circ\text{C}$	14.8			V
		$R_L = 2\text{ k}\Omega$ to $V_{CM}$	14.5	14.6		V
		$-40^\circ\text{C} \leq T_A \leq +125^\circ\text{C}$	14.0			V
Output Voltage Low	$V_{OL}$	$R_L = 10\text{ k}\Omega$ to $V_{CM}$		-14.95	-14.9	V
		$-40^\circ\text{C} \leq T_A \leq +125^\circ\text{C}$			-14.8	V
		$R_L = 2\text{ k}\Omega$ to $V_{CM}$		-14.9	-14.8	V
		$-40^\circ\text{C} \leq T_A \leq +125^\circ\text{C}$			-14.7	V
Short-Circuit Current	$I_{SC}$		$\pm 30$			mA
Closed-Loop Output Impedance	$Z_{OUT}$	$f = 1\text{ kHz}$ , $A_V = +1$		0.1		$\Omega$
<b>POWER SUPPLY</b>						
Power Supply Rejection Ratio	PSRR	$V_{SY} = \pm 2\text{ V}$ to $\pm 18\text{ V}$	110	120		dB
		$-40^\circ\text{C} \leq T_A \leq +125^\circ\text{C}$	105			dB
Supply Current per Amplifier	$I_{SY}$	$I_{OUT} = 0\text{ mA}$		0.625	0.750	mA
		$-40^\circ\text{C} \leq T_A \leq +125^\circ\text{C}$			1.050	mA
<b>DYNAMIC PERFORMANCE</b>						
Slew Rate	SR	$R_L = 2\text{ k}\Omega$	2.4	4.6		V/ $\mu\text{s}$
Gain Bandwidth Product	GBP	$V_{IN} = 5\text{ mV p-p}$ , $R_L = 10\text{ k}\Omega$ , $A_V = 100$		15.9		MHz
Unity-Gain Crossover	UGC	$V_{IN} = 5\text{ mV p-p}$ , $R_L = 10\text{ k}\Omega$ , $A_V = 1$		9.9		MHz
Phase Margin	$\Phi_M$			86		Degrees
-3 dB Closed-Loop Bandwidth	-3 dB	$A_V = 1$ , $V_{IN} = 5\text{ mV p-p}$		13.9		MHz
Settling Time	$t_S$	$A_V = 10$ , $V_{IN} = 10\text{ V p-p}$ , 0.1%		4		$\mu\text{s}$
Total Harmonic Distortion Plus Noise	THD + N	$V_{IN} = 5\text{ V rms}$ , $R_L = 2\text{ k}\Omega$ , $f = 1\text{ kHz}$		0.003		%
<b>NOISE PERFORMANCE</b>						
Voltage Noise	$e_n$ p-p	0.1 Hz to 10 Hz		0.1		$\mu\text{V p-p}$
Voltage Noise Density	$e_n$	$f = 1\text{ kHz}$		3.9		nV/ $\sqrt{\text{Hz}}$
Current Noise Density	$i_n$	$f = 1\text{ kHz}$		0.55		pA/ $\sqrt{\text{Hz}}$

## ABSOLUTE MAXIMUM RATINGS

Table 5.

Parameter	Rating
Supply Voltage	±18 V
Input Voltage	$V- \leq V_{IN} \leq V+$
Differential Input Voltage <sup>1</sup>	±0.6 V
Output Short-Circuit Duration to GND	Indefinite
Storage Temperature Range	-65°C to +150°C
Operating Temperature Range	-40°C to +125°C
Junction Temperature Range	-65°C to +150°C
Lead Temperature (Soldering 60 sec)	300°C
<b>ESD</b>	
Human Body Model <sup>2</sup>	4.5 kV
Machine Model <sup>3</sup>	200 V
Field-Induced Charged-Device Model (FICDM) <sup>4</sup>	1.25 kV

<sup>1</sup> For input differential voltages greater than 0.6 V, limit the input current to less than 5 mA to prevent degradation or destruction of the input devices.

<sup>2</sup> Applicable standard: MIL-STD-883, Method 3015.7.

<sup>3</sup> Applicable standard: JESD22-A115-A (ESD machine model standard of JEDEC).

<sup>4</sup> Applicable standard: JESD22-C101-C (ESD FICDM standard of JEDEC).

Stresses at or above those listed under Absolute Maximum Ratings may cause permanent damage to the product. This is a stress rating only; functional operation of the product at these or any other conditions above those indicated in the operational section of this specification is not implied. Operation beyond the maximum operating conditions for extended periods may affect product reliability.

## THERMAL RESISTANCE

$\theta_{JA}$  is specified for the device soldered on a 4-layer JEDEC standard printed circuit board (PCB) with zero airflow.

Table 6. Thermal Resistance

Package Type	$\theta_{JA}$	$\theta_{JC}$	Unit
5-Lead SOT-23 (RJ-5)	219.4	155.6	°C/W
8-Lead SOIC_N (R-8)	121	43	°C/W
8-Lead MSOP (RM-8)	142	45	°C/W
8-Lead LFCSP (CP-8-12) <sup>1,3</sup>	84	40	°C/W
14-Lead TSSOP (RU-14)	112	43	°C/W
16-Lead LFCSP (CP-16-26) <sup>2,3</sup>	55	30	°C/W

<sup>1</sup> Values are based on 4-layer (252P) JEDEC standard PCB, with four thermal vias. Exposed pad soldered to PCB.

<sup>2</sup> Values are based on 4-layer (252P) JEDEC standard PCB, with nine thermal vias. Exposed pad soldered to PCB.

<sup>3</sup>  $\theta_{JC}$  measured on top of package.

## ESD CAUTION



**ESD (electrostatic discharge) sensitive device.** Charged devices and circuit boards can discharge without detection. Although this product features patented or proprietary protection circuitry, damage may occur on devices subjected to high energy ESD. Therefore, proper ESD precautions should be taken to avoid performance degradation or loss of functionality.

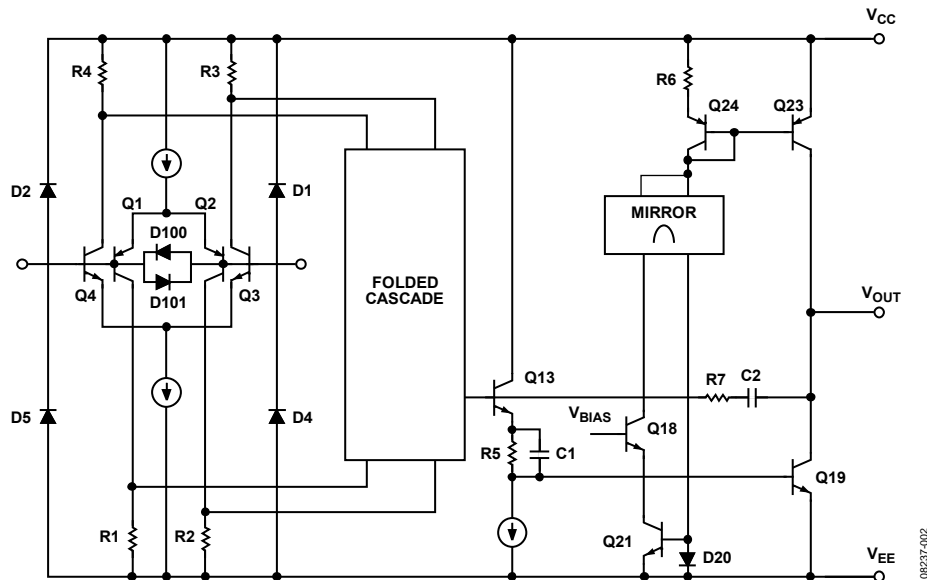

Figure 2. Simplified Schematic

## PIN CONFIGURATIONS AND FUNCTION DESCRIPTIONS

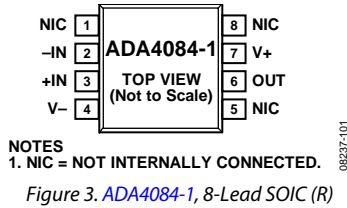

Table 7. 8-Lead SOIC, ADA4084-1 Pin Function Descriptions

Pin No.	Mnemonic	Description
1	NIC	Not Internally Connected
2	-IN	Negative Input
3	+IN	Positive Input
4	V-	Negative Supply
5	NIC	Not Internally Connected
6	OUT	Output
7	V+	Positive Supply
8	NIC	Not Internally Connected

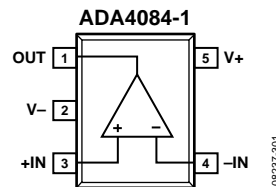

Table 8. 5-Lead SOT-23, ADA4084-1 Pin Function Descriptions

Pin No.	Mnemonic	Description
1	OUT	Output
2	V-	Negative Supply
3	+IN	Positive Input
4	-IN	Negative Input
5	V+	Positive Supply

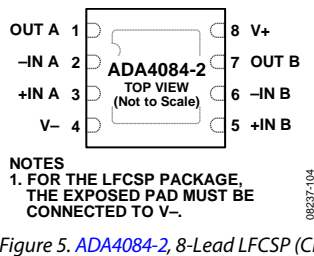

Table 9. 8-Lead LFCSP, ADA4084-2 Pin Function Descriptions

Pin No.	Mnemonic	Description
1	OUT A	Output, Channel A
2	-IN A	Negative Input, Channel A
3	+IN A	Positive Input, Channel A
4	V-	Negative Supply
5	+IN B	Positive Input, Channel B
6	-IN B	Negative Input, Channel B
7	OUT B	Output, Channel B
8	V+	Positive Supply
	EPAD	Exposed Pad. For the LFCSP package, the exposed pad must be connected to V-.



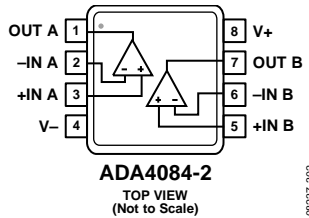

Figure 6. ADA4084-2, 8-Lead MSOP (RM)

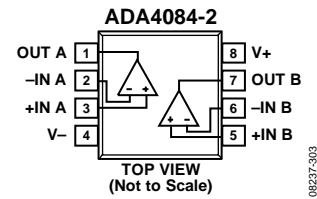

Figure 7. ADA4084-2, 8-Lead SOIC (R)

Table 10. 8-Lead MSOP, 8-Lead SOIC, ADA4084-2 Pin Function Descriptions

Pin No.	Mnemonic	Description
1	OUT A	Output, Channel A
2	-IN A	Negative Input, Channel A
3	+IN A	Positive Input, Channel A
4	V-	Negative Supply
5	+IN B	Positive Input, Channel B
6	-IN B	Negative Input, Channel B
7	OUT B	Output, Channel B
8	V+	Positive Supply B

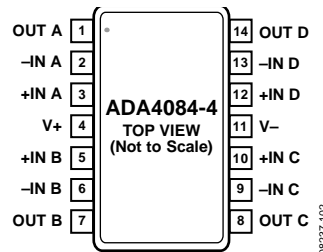
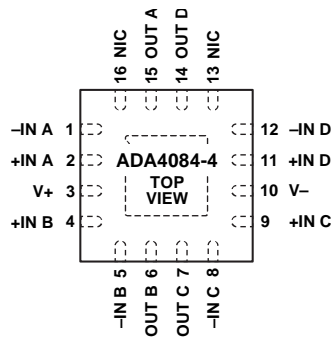

Figure 8. ADA4084-4, 14-Lead TSSOP (RU)

Table 11. 14-Lead TSSOP, ADA4804-4 Pin Function Descriptions

Pin No.	Mnemonic	Description
1	OUT A	Output, Channel A
2	-IN A	Negative Input, Channel A
3	+IN A	Positive Input, Channel A
4	V+	Positive Supply
5	+IN B	Positive Input, Channel B
6	-IN B	Negative Input, Channel B
7	OUT B	Output, Channel B
8	OUT C	Output, Channel C
9	-IN C	Negative Input, Channel C
10	+IN C	Positive Input, Channel C
11	V-	Negative Supply
12	+IN D	Positive Input, Channel D
13	-IN D	Negative Input, Channel D
14	OUT D	Output, Channel D



NOTES  
 1. NIC = NOT INTERNALLY CONNECTED.  
 2. FOR THE LFCSP PACKAGE, THE EXPOSED PAD MUST BE CONNECTED TO V-.

0823F-103

Figure 9. ADA4084-4, 16-Lead LFCSP (CP)

Table 12. 16-Lead LFCSP, ADA4084-4 Pin Function Descriptions

Pin No.	Mnemonic	Description
1	-IN A	Negative Input Channel A
2	+IN A	Positive Input, Channel A
3	V+	Positive Supply
4	+IN B	Positive Input, Channel B
5	-IN B	Negative Input, Channel B
6	OUT B	Output, Channel B
7	OUT C	Output, Channel C
8	-IN C	Negative Input, Channel C
9	+IN C	Positive Input, Channel C
10	V-	Negative Supply
11	+IN D	Positive Input, Channel D
12	-IN D	Negative Input, Channel D
13	NIC	Not Internally Connected
14	OUT D	Output, Channel D
15	OUT A	Output, Channel A
16	NIC	Not Internally Connected

# TYPICAL PERFORMANCE CHARACTERISTICS

$T_A = 25^\circ\text{C}$ , unless otherwise noted.

## $\pm 1.5\text{ V}$ CHARACTERISTICS

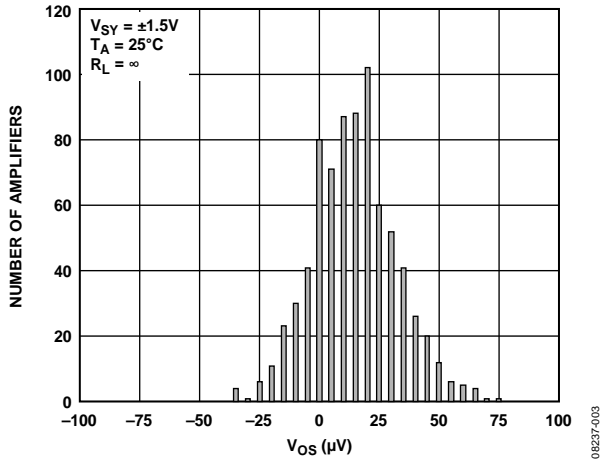

Figure 10. Input Offset Voltage ( $V_{os}$ ) Distribution, SOIC

08237-003

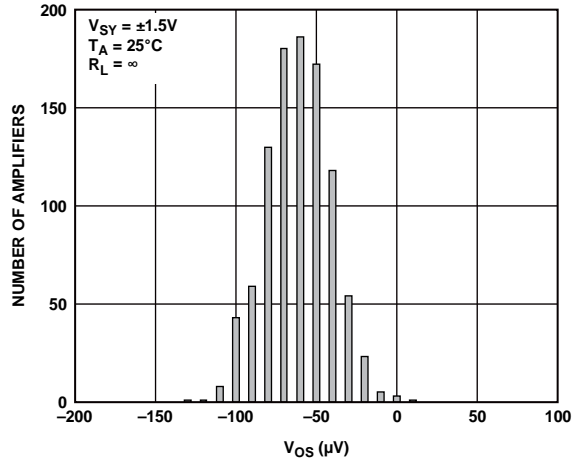

Figure 13. Input Offset Voltage ( $V_{os}$ ) Distribution, LFCSP

08237-081

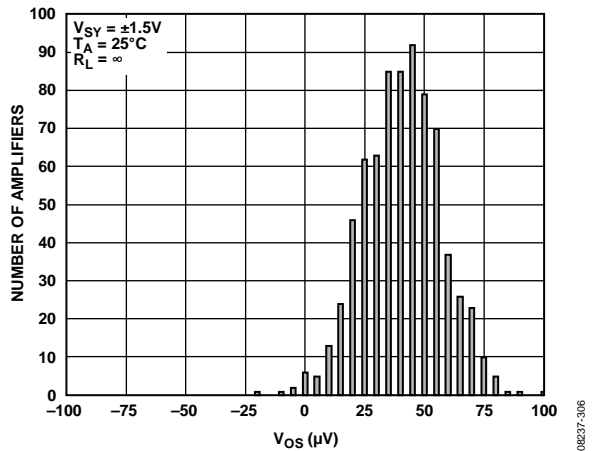

Figure 11. Input Offset Voltage ( $V_{os}$ ) Distribution, SOT-23

08237-306

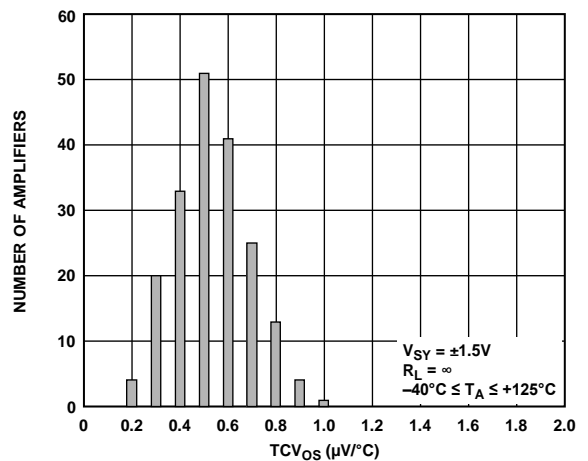

Figure 14.  $TCV_{os}$  Distribution, SOIC, MSOP, and TSSOP

08237-006

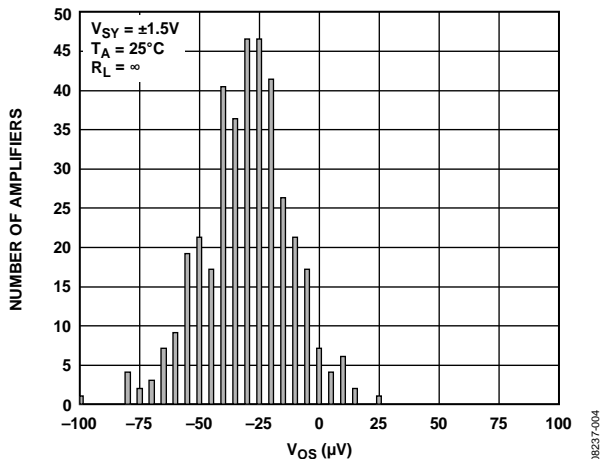

Figure 12. Input Offset Voltage ( $V_{os}$ ) Distribution, MSOP and TSSOP

08237-004

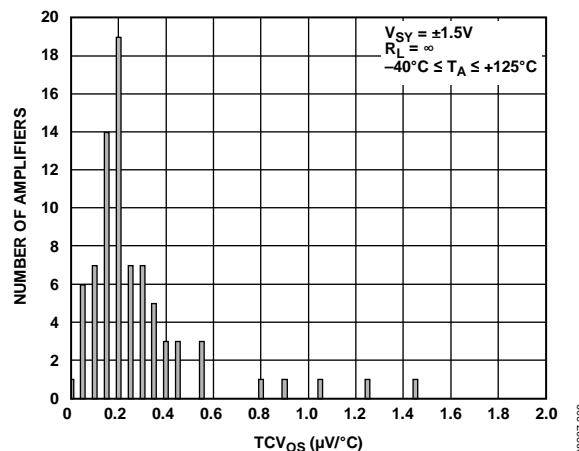

Figure 15.  $TCV_{os}$  Distribution, SOT-23

08237-309

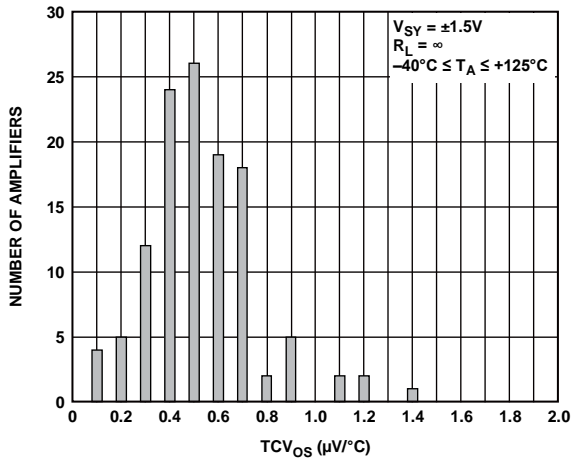

Figure 16.  $TCV_{OS}$  Distribution, LFCSP

08237-082

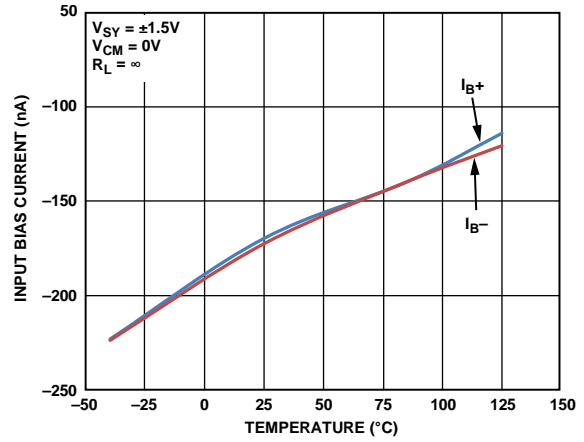

Figure 19. Input Bias Current vs. Temperature

08237-213

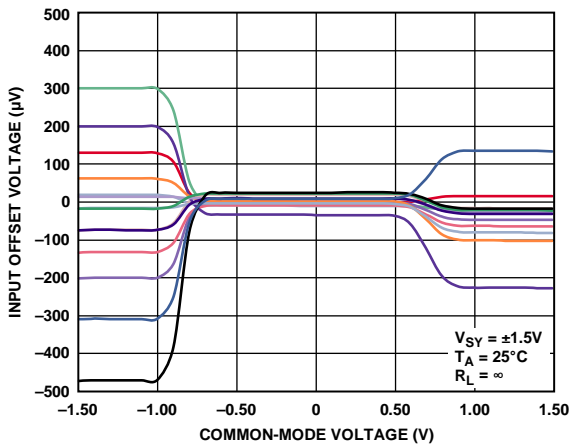

Figure 17. Input Offset Voltage vs. Common-Mode Voltage

08237-006

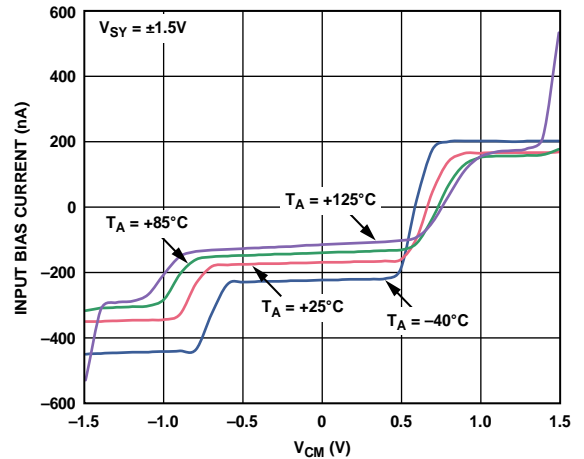

Figure 20. Input Bias Current vs.  $V_{CM}$  for Various Temperatures

08237-008

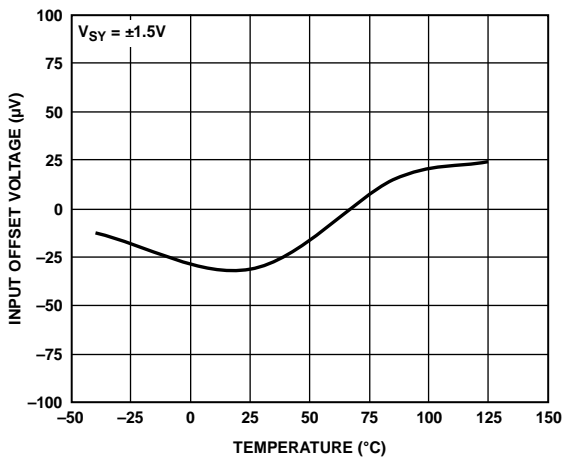

Figure 18. Input Offset Voltage vs. Temperature

08237-108

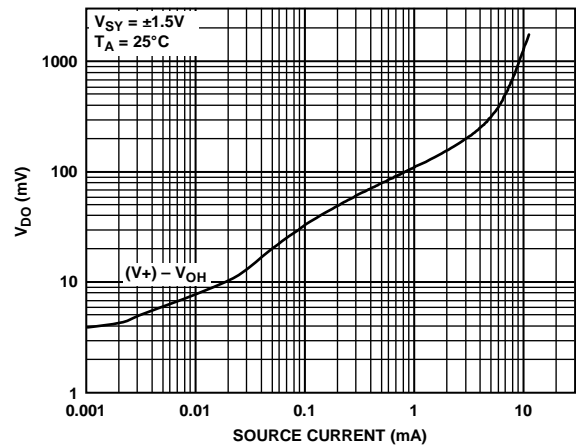

Figure 21. Dropout Voltage ( $V_{DO}$ ) vs. Source Current

08237-009

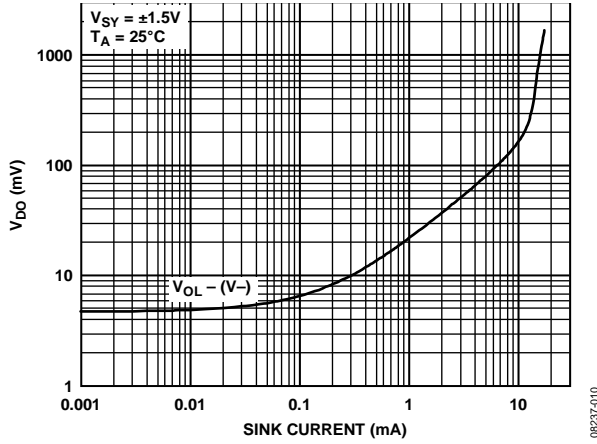

Figure 22. Dropout Voltage ( $V_{DO}$ ) vs. Sink Current

08237-010

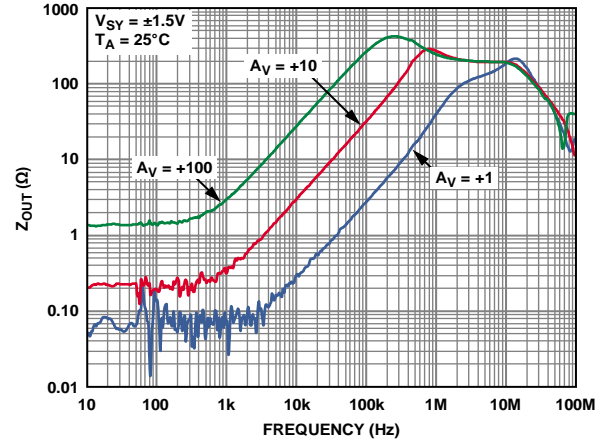

Figure 25. Output Impedance ( $Z_{OUT}$ ) vs. Frequency

08237-013

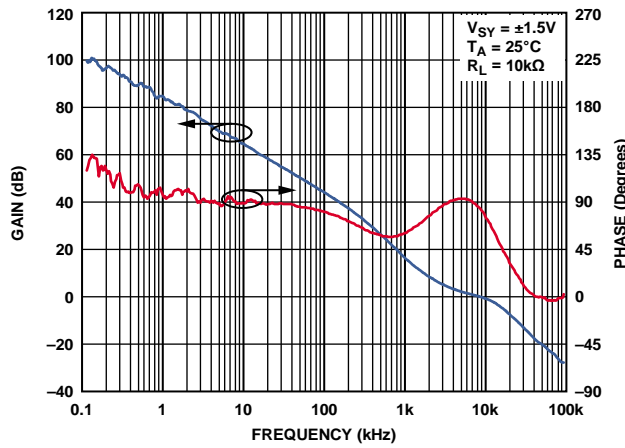

Figure 23. Open-Loop Gain and Phase vs. Frequency

08237-011

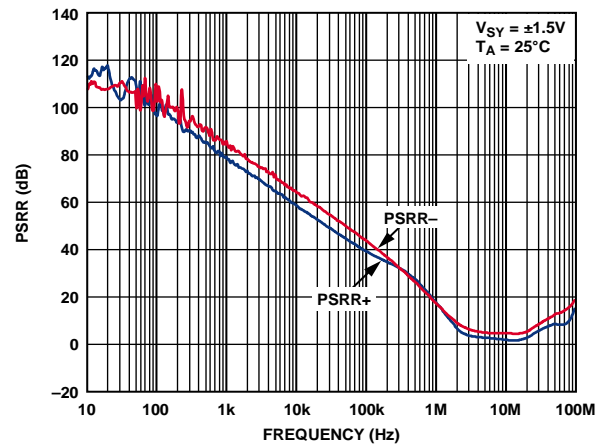

Figure 26. PSRR vs. Frequency

08237-014

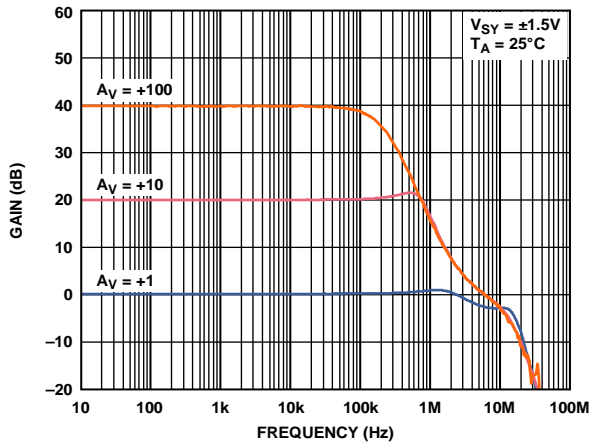

Figure 24. Closed-Loop Gain vs. Frequency

08237-012

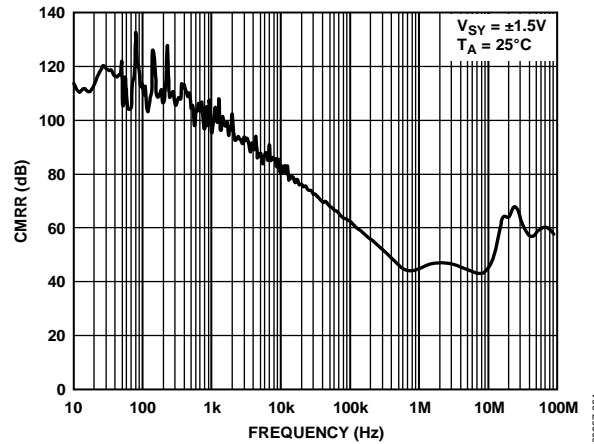

Figure 27. CMRR vs. Frequency

08237-021

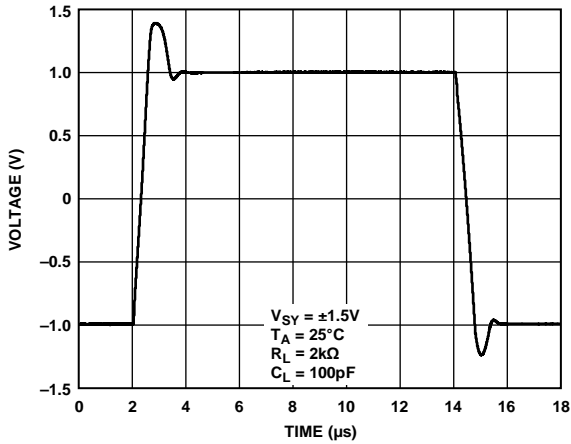

Figure 28. Large Signal Transient Response

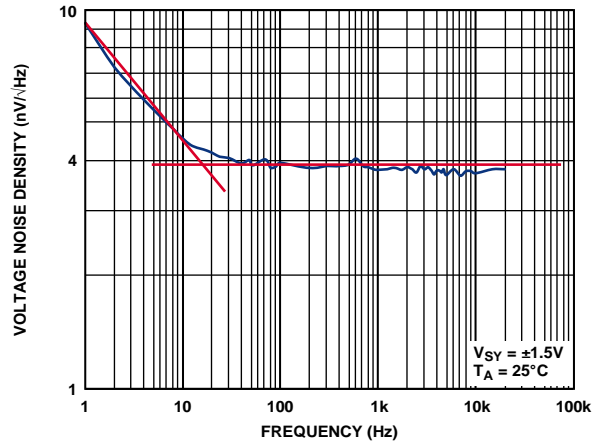

Figure 31. Voltage Noise Density vs. Frequency

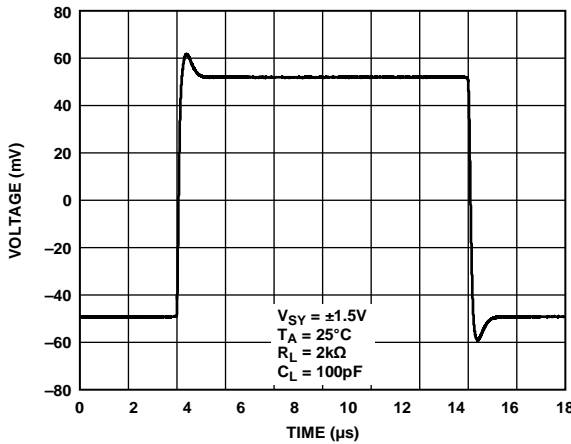

Figure 29. Small Signal Transient Response

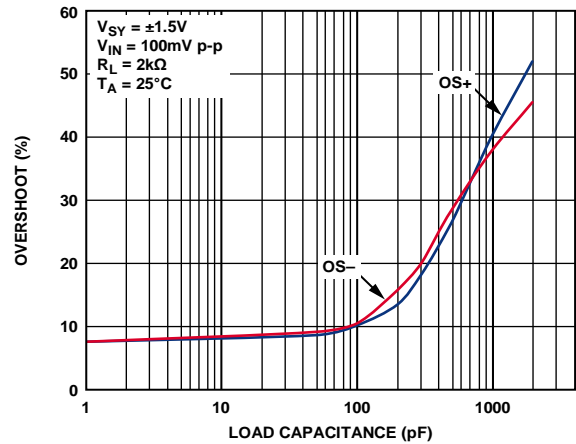

Figure 32. Overshoot vs. Load Capacitance

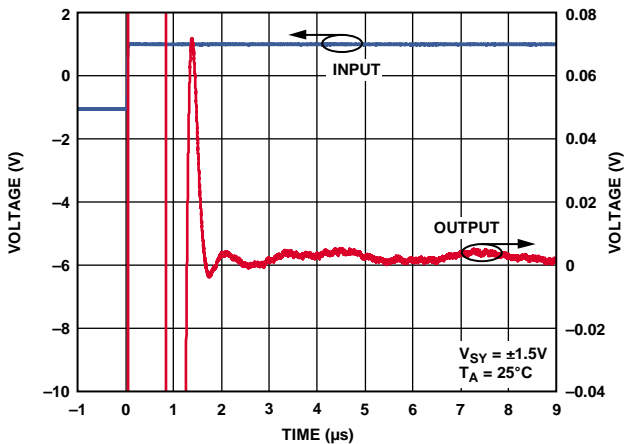

Figure 30. Settling Time

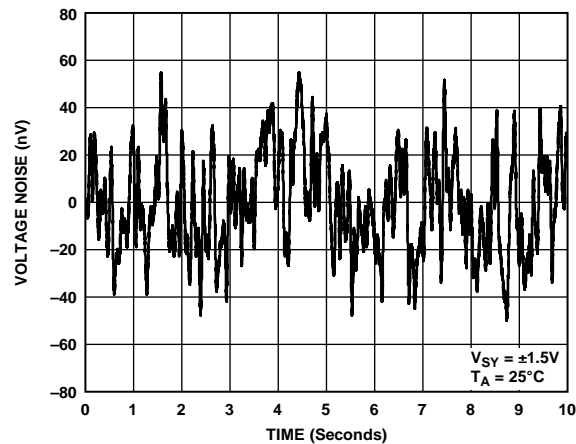

Figure 33. Voltage Noise, 0.1 Hz to 10 Hz

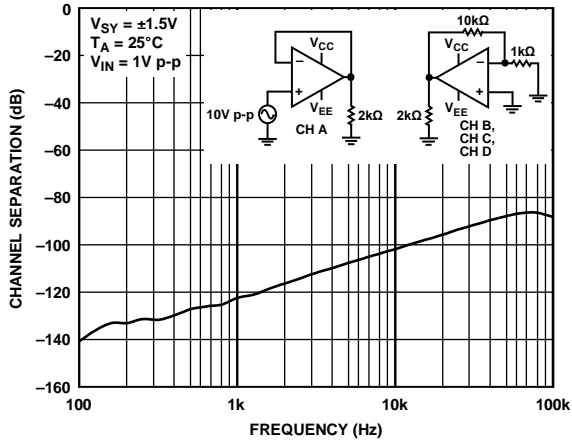

Figure 34. Channel Separation vs. Frequency

08237-022

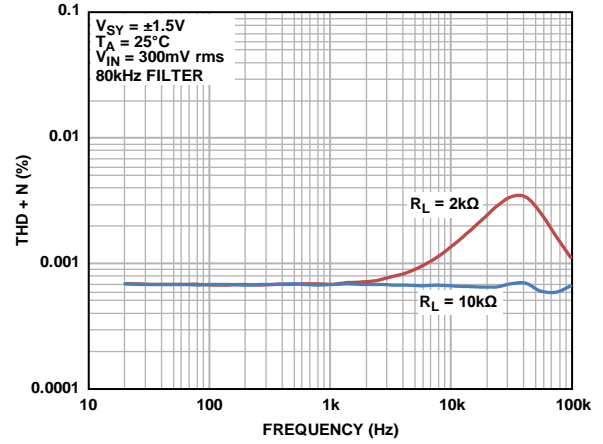

Figure 37. THD + N vs. Frequency, 80 kHz Filter

08237-231

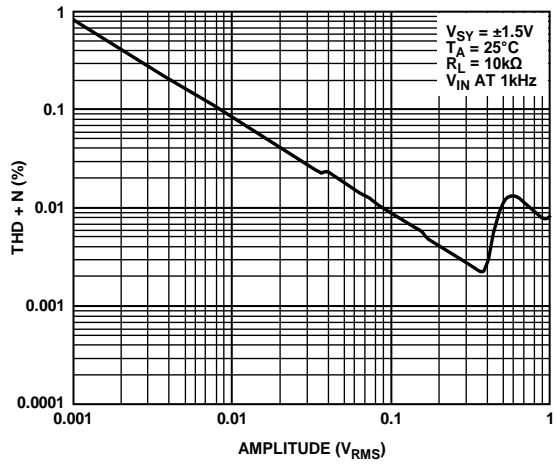

Figure 35. THD + N vs. Amplitude

08237-125

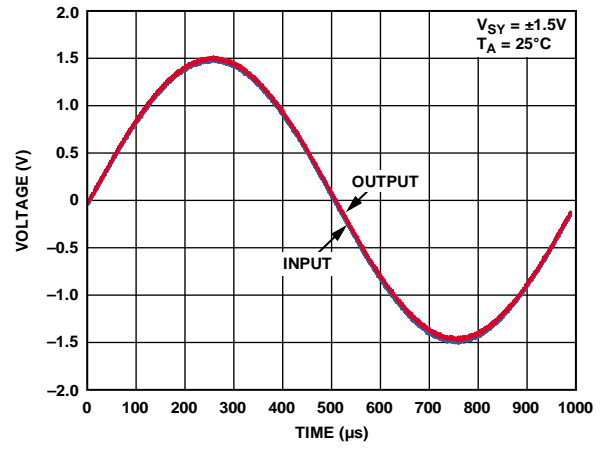

Figure 38. No Phase Reversal

08237-025

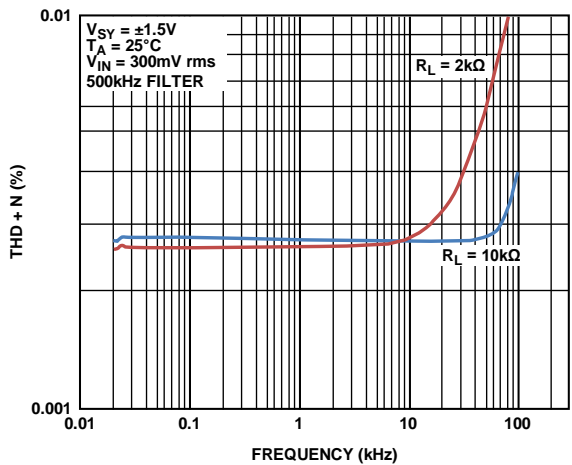

Figure 36. THD + N vs. Frequency, 500 kHz Filter

08237-126

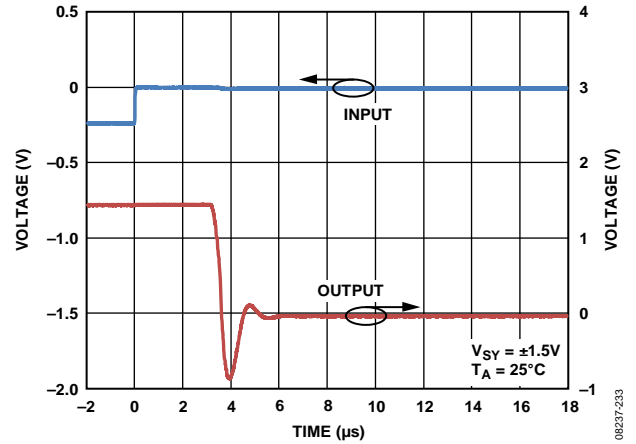

Figure 39. Positive 50% Overload Recovery

08237-233

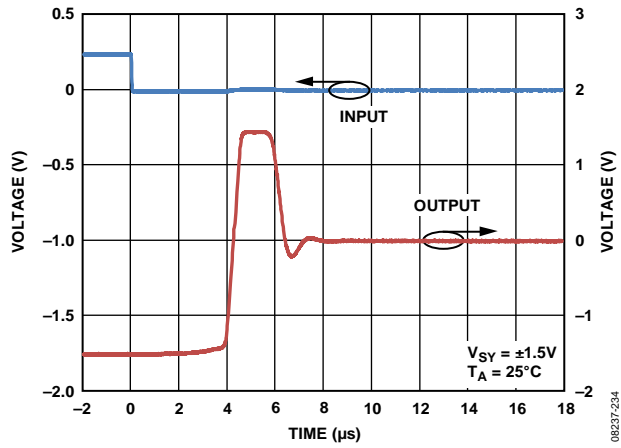

Figure 40. Negative 50% Overload Recovery



**±5 V CHARACTERISTICS**

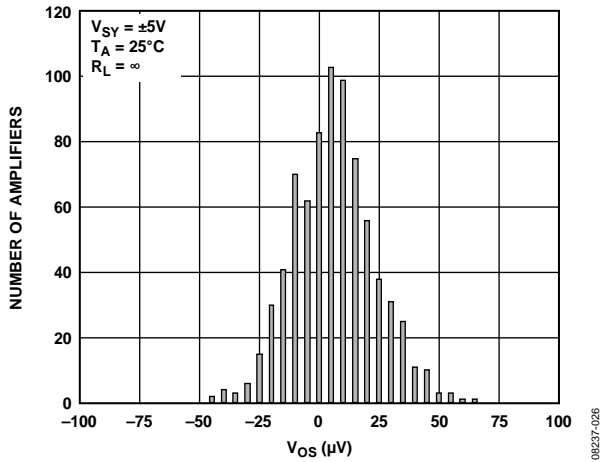

Figure 41. Input Offset Voltage ( $V_{OS}$ ) Distribution, SOIC

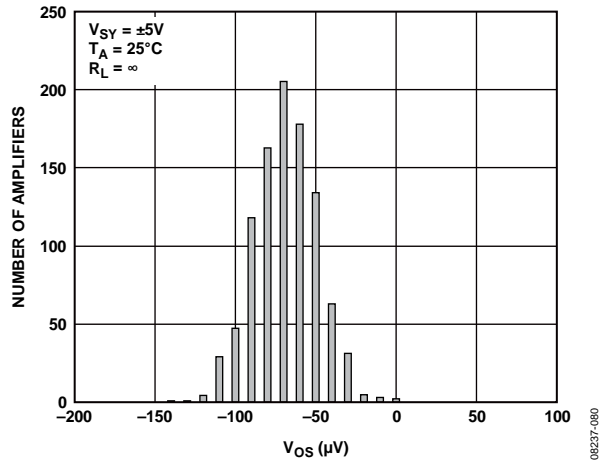

Figure 44. Input Offset Voltage ( $V_{OS}$ ) Distribution, LFCSP

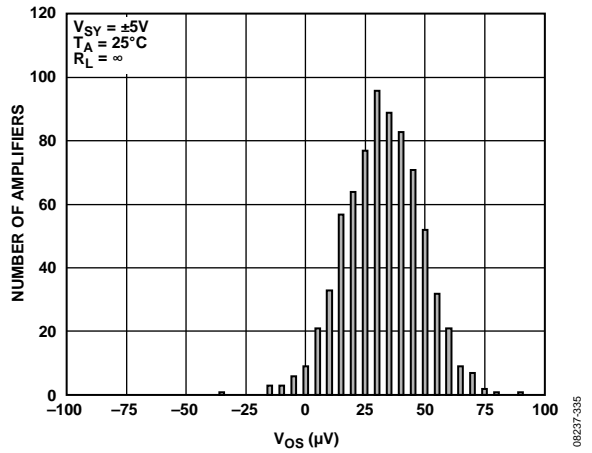

Figure 42. Input Offset Voltage ( $V_{OS}$ ) Distribution, SOT-23

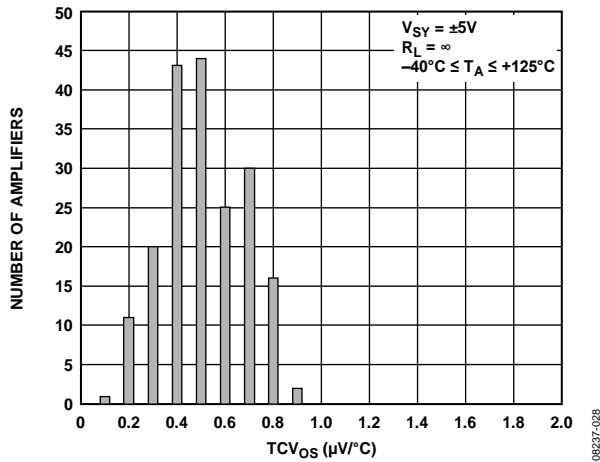

Figure 45.  $TCV_{OS}$  Distribution, SOIC, MSOP, and TSSOP

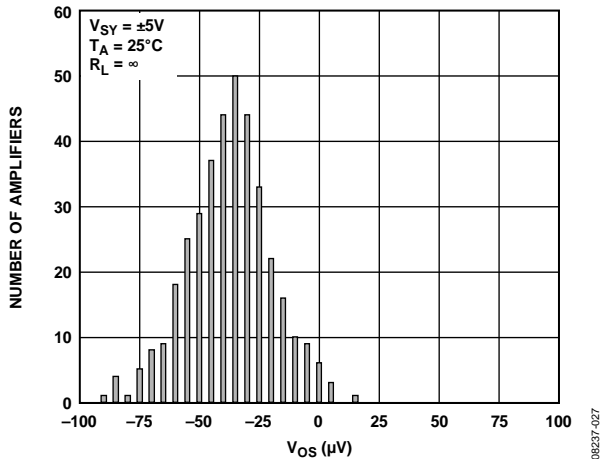

Figure 43. Input Offset Voltage ( $V_{OS}$ ) Distribution, MSOP and TSSOP

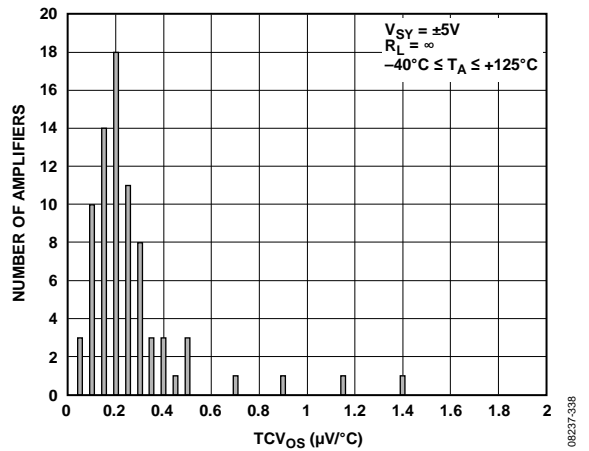

Figure 46.  $TCV_{OS}$  Distribution for SOT-23

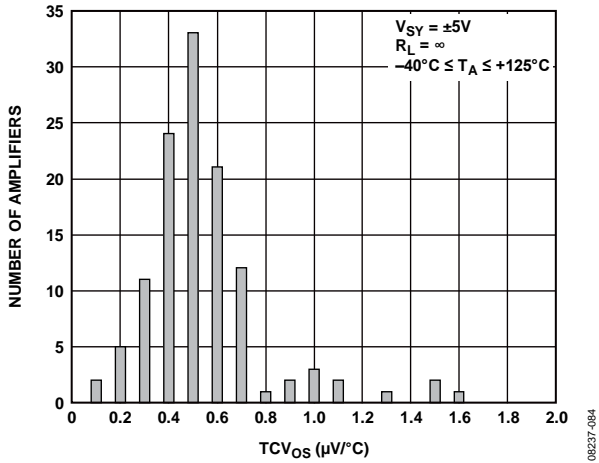

Figure 47. TCV<sub>OS</sub> Distribution, LFCSP

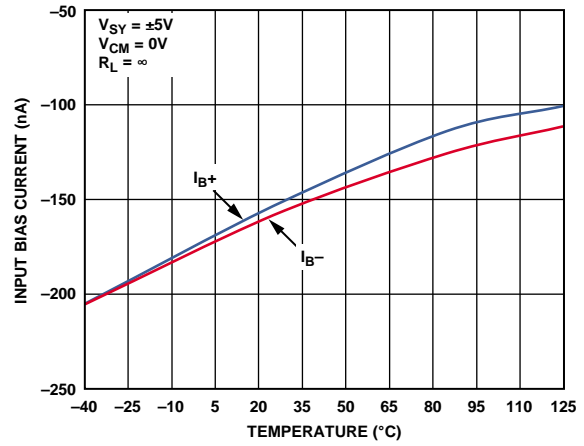

Figure 50. Input Bias Current vs. Temperature

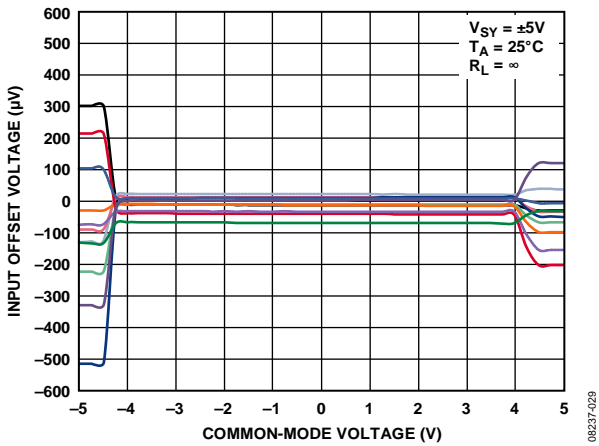

Figure 48. Input Offset Voltage vs. Common-Mode Voltage

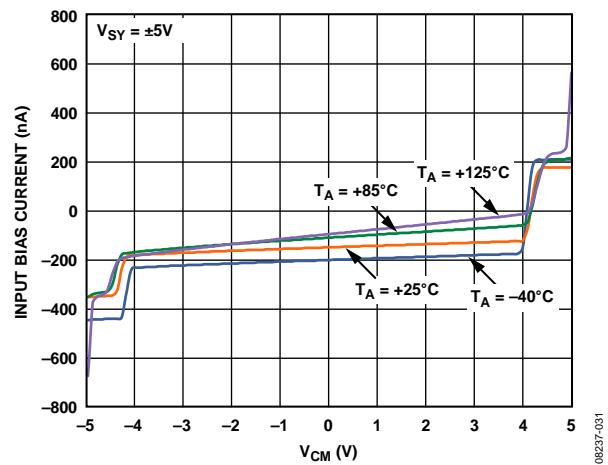

Figure 51. Input Bias Current vs. V<sub>CM</sub> for Various Temperatures

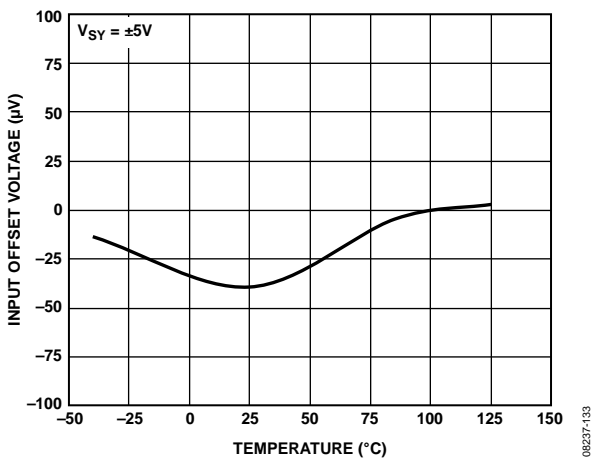

Figure 49. Input Offset Voltage vs. Temperature

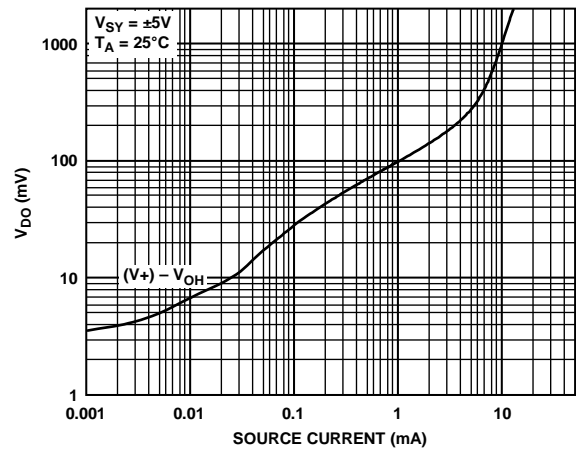

Figure 52. Dropout Voltage (V<sub>DO</sub>) vs. Source Current

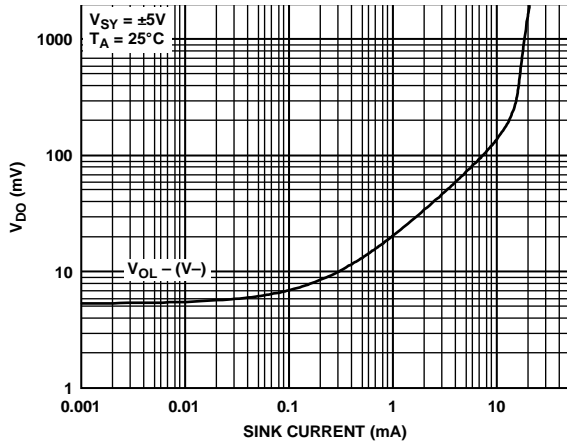

Figure 53. Dropout Voltage ( $V_{Do}$ ) vs. Sink Current

08237-033

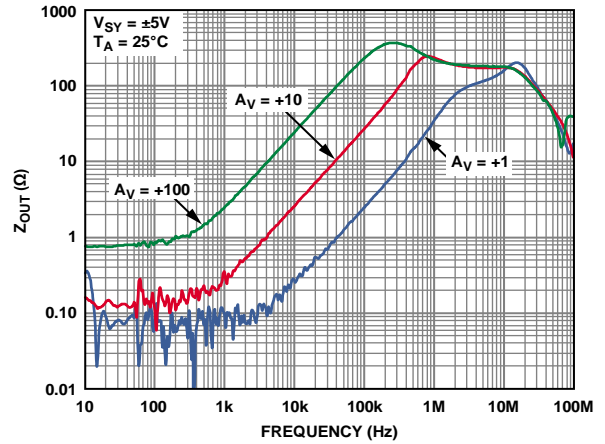

Figure 56. Output Impedance ( $Z_{out}$ ) vs. Frequency

08237-036

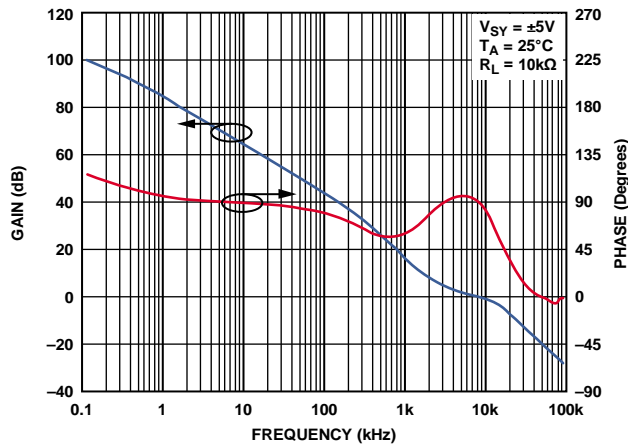

Figure 54. Open-Loop Gain and Phase vs. Frequency

08237-034

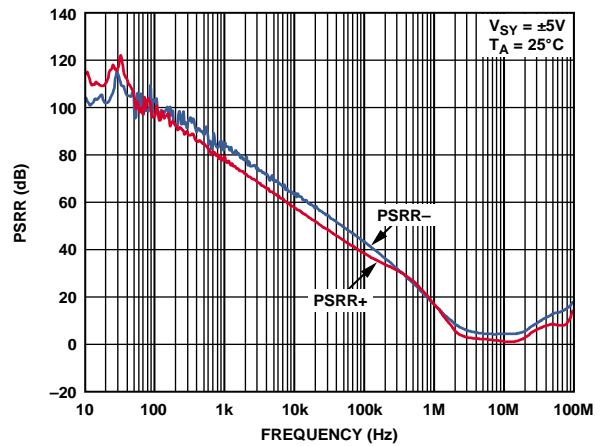

Figure 57. PSRR vs. Frequency

08237-037

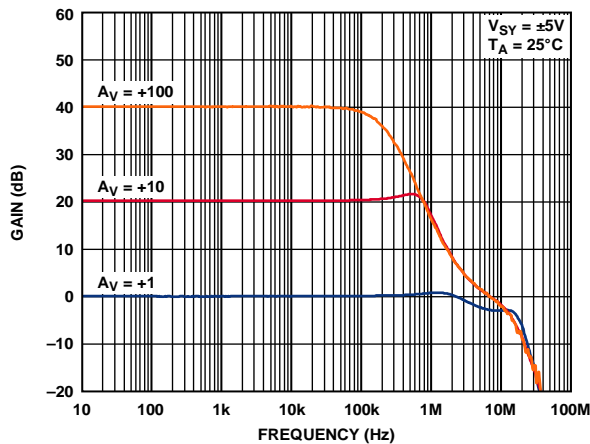

Figure 55. Closed-Loop Gain vs. Frequency

08237-035

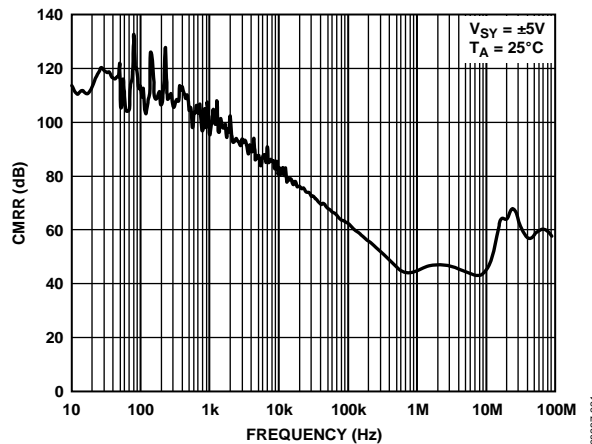

Figure 58. CMRR vs. Frequency

08237-221

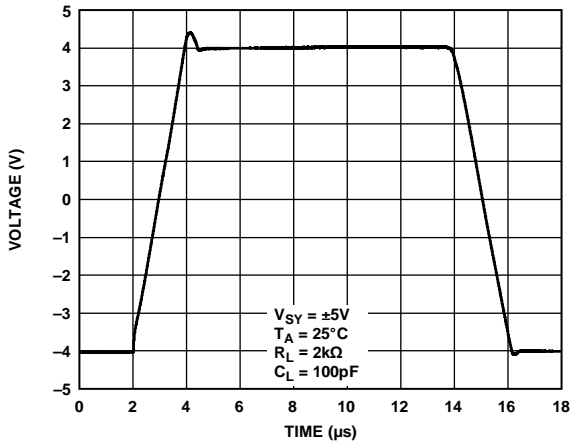

Figure 59. Large Signal Transient Response

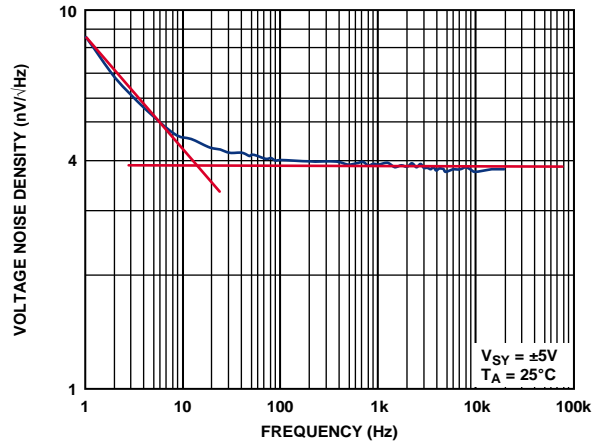

Figure 62. Voltage Noise Density vs. Frequency

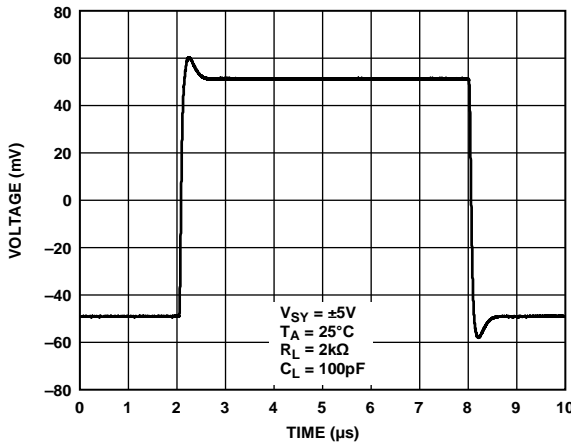

Figure 60. Small Signal Transient Response

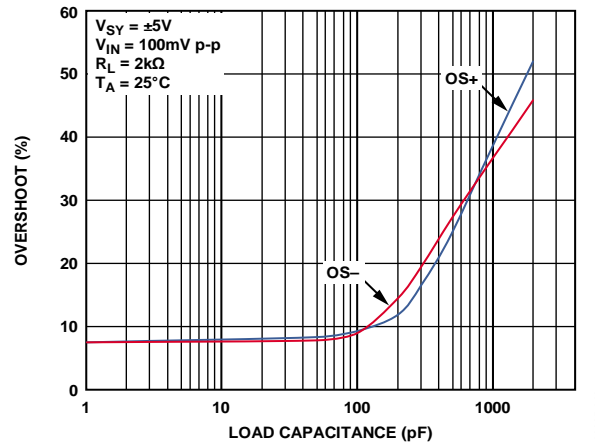

Figure 63. Overshoot vs. Load Capacitance

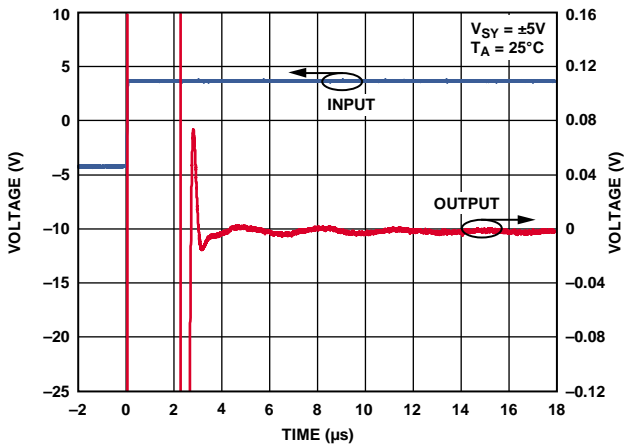

Figure 61. Settling Time

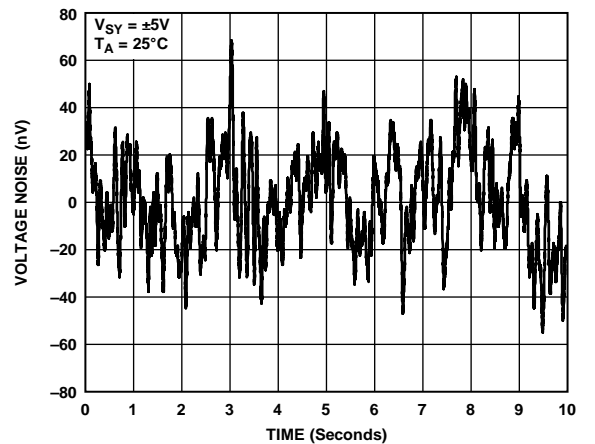

Figure 64. Voltage Noise, 0.1 Hz to 10 Hz

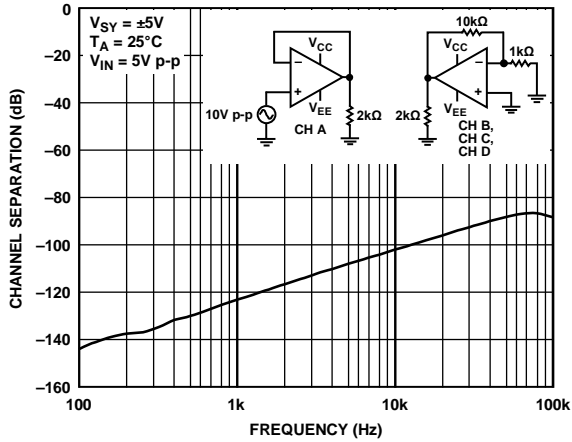

Figure 65. Channel Separation vs. Frequency

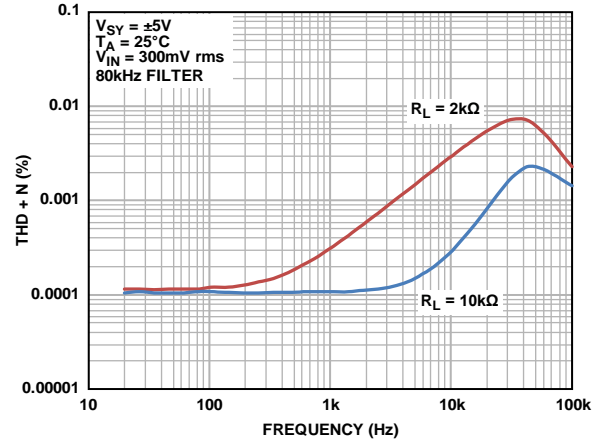

Figure 68. THD + N vs. Frequency, 80 kHz Filter

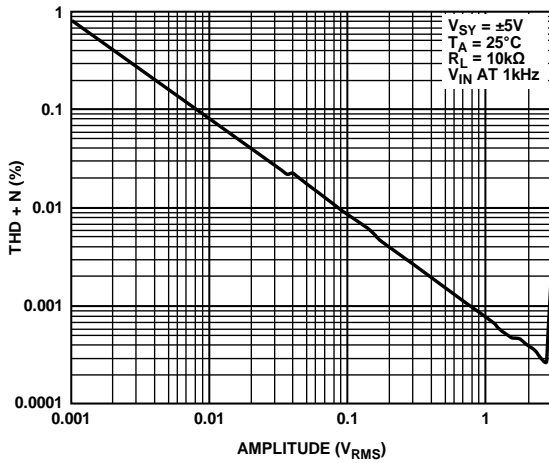

Figure 66. THD + N vs. Amplitude

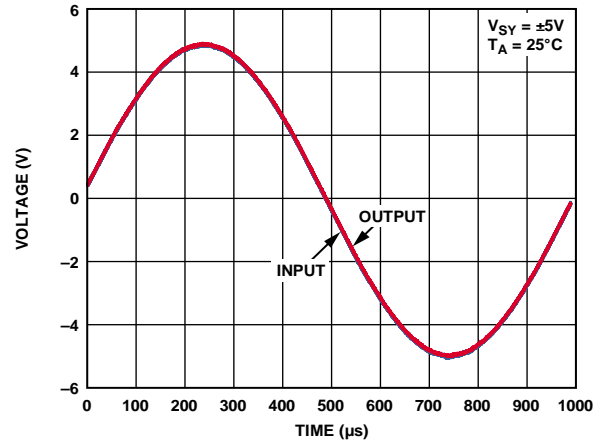

Figure 69. No Phase Reversal

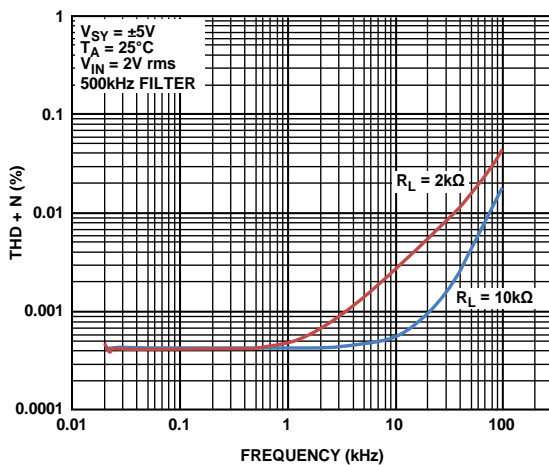

Figure 67. THD + N vs. Frequency, 500 kHz Filter

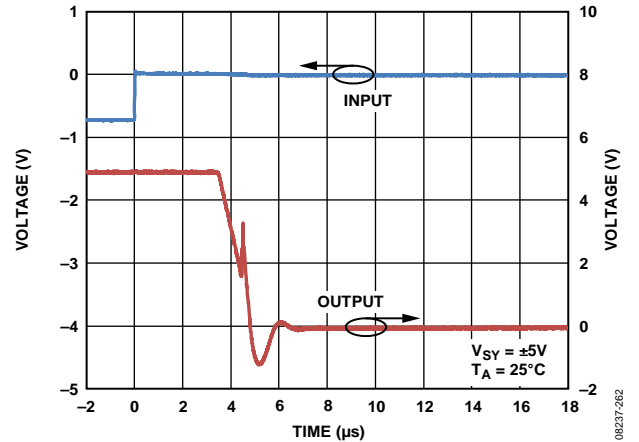

Figure 70. Positive 50% Overload Recovery

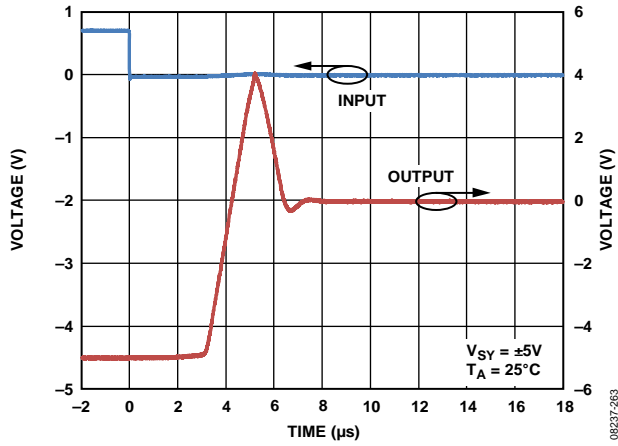

Figure 71. Negative 50% Overload Recovery

**±15 V CHARACTERISTICS**

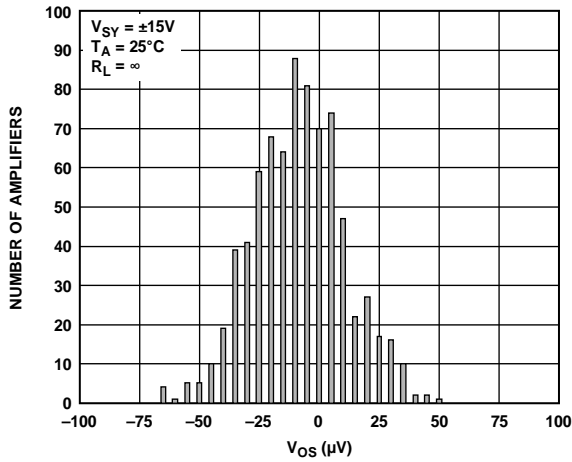

Figure 72. Input Offset Voltage ( $V_{OS}$ ) Distribution, SOIC

08237-049

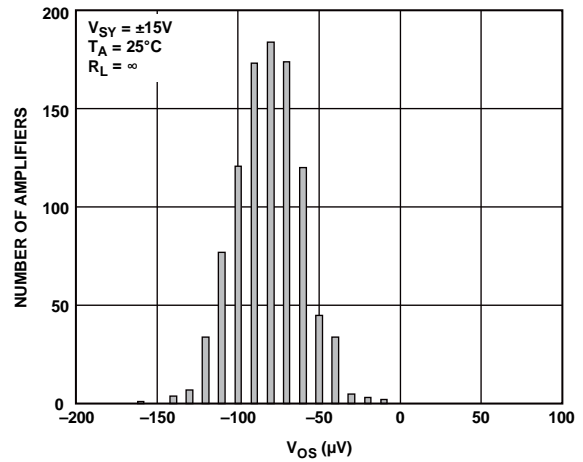

Figure 75. Input Offset Voltage ( $V_{OS}$ ) Distribution, LFCSP

08237-079

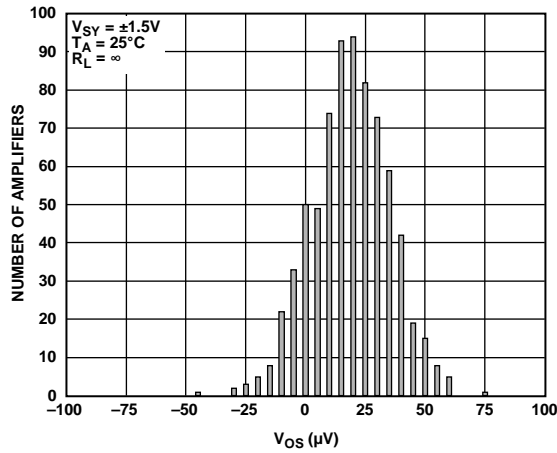

Figure 73. Input Offset Voltage ( $V_{OS}$ ) Distribution, SOT-23

08237-364

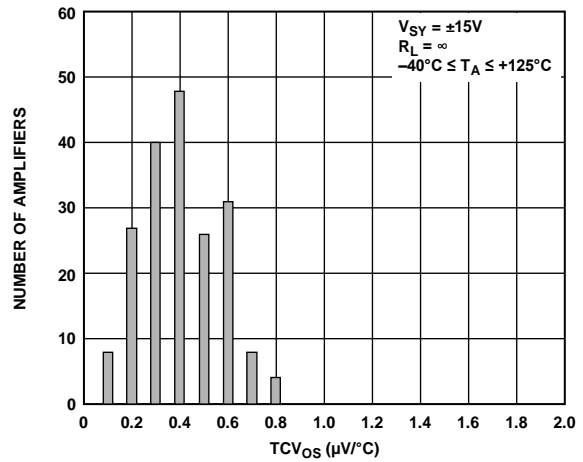

Figure 76.  $TCV_{OS}$  Distribution, SOIC, MSOP, and TSSOP

08237-051

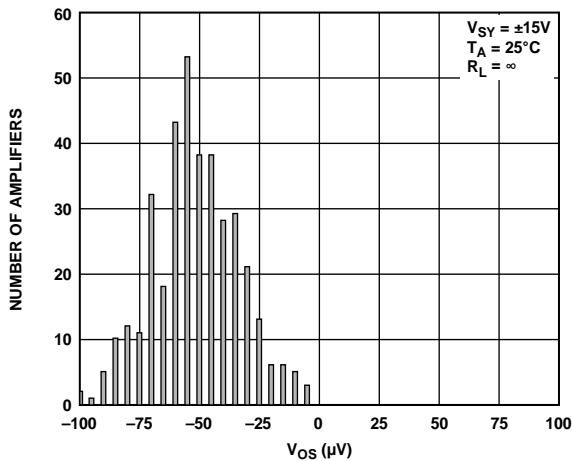

Figure 74. Input Offset Voltage ( $V_{OS}$ ) Distribution, MSOP and TSSOP

08237-050

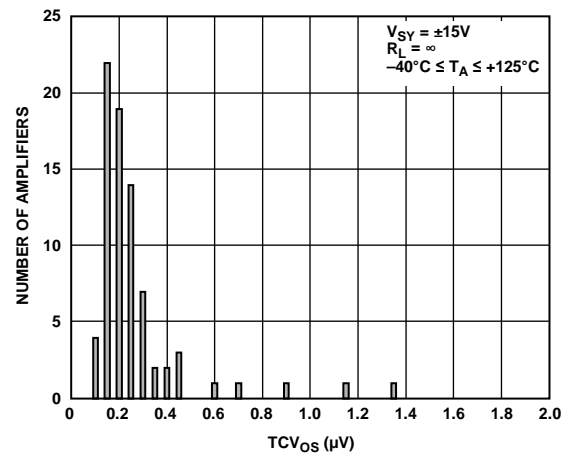

Figure 77.  $TCV_{OS}$  Distribution, SOT-23

08237-367

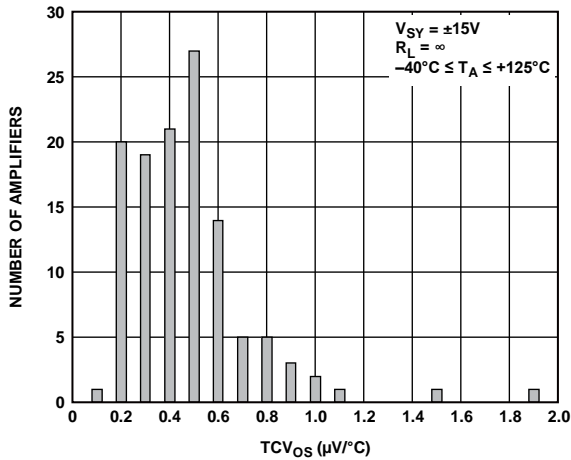

Figure 78. TCV<sub>os</sub> Distribution, LFCSP

08237-085

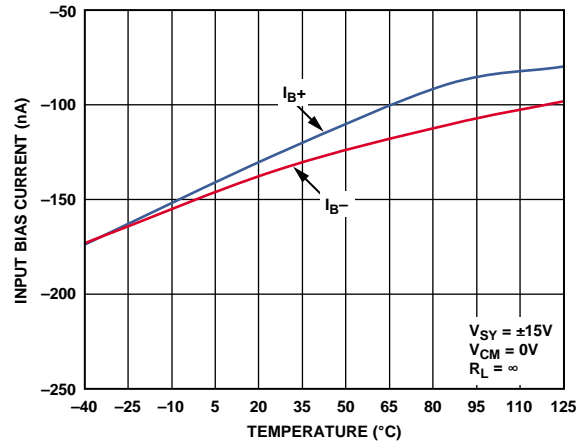

Figure 81. Input Bias Current vs. Temperature

08237-053

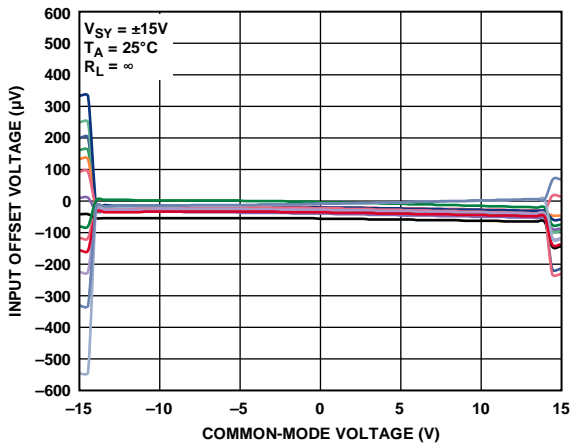

Figure 79. Input Offset Voltage vs. Common-Mode Voltage

08237-052

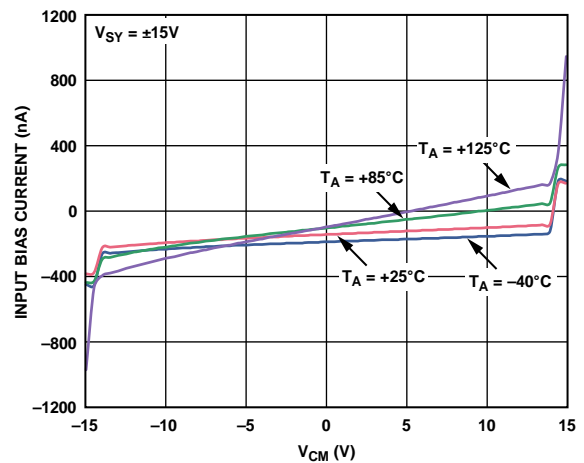

Figure 82. Input Bias Current vs. V<sub>CM</sub> for Various Temperatures

08237-054

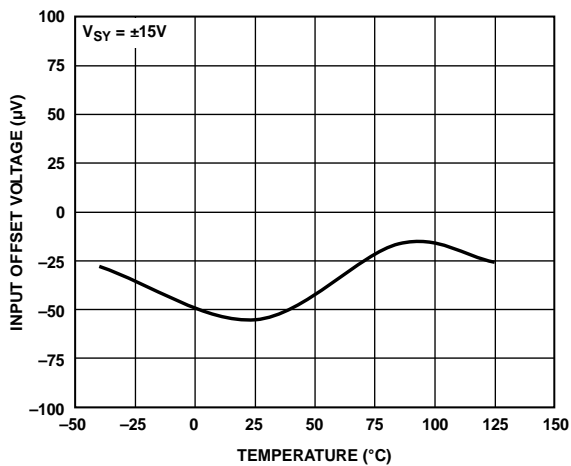

Figure 80. Input Offset Voltage vs. Temperature

08237-166

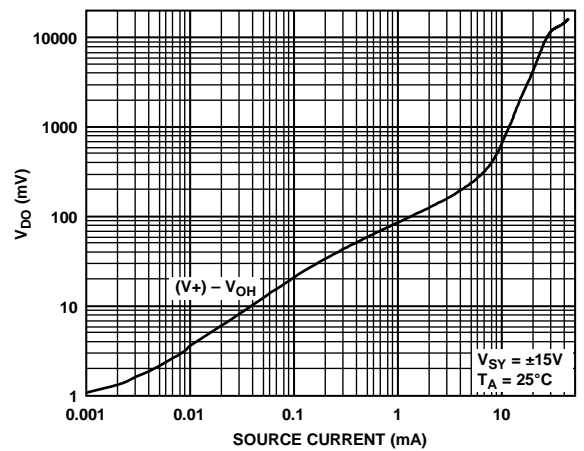

Figure 83. Dropout Voltage (V<sub>DO</sub>) vs. Source Current

08237-055



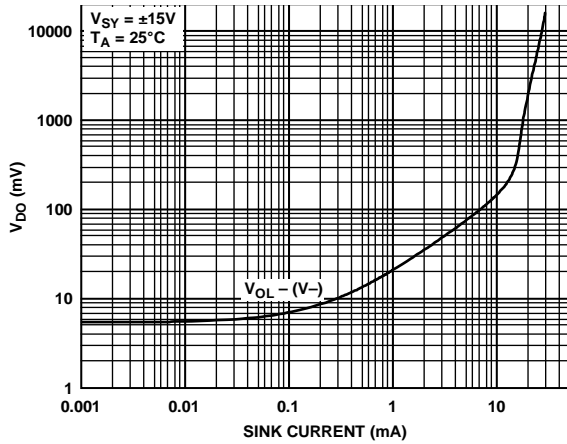

Figure 84. Dropout Voltage ( $V_{DO}$ ) vs. Sink Current

08237-056

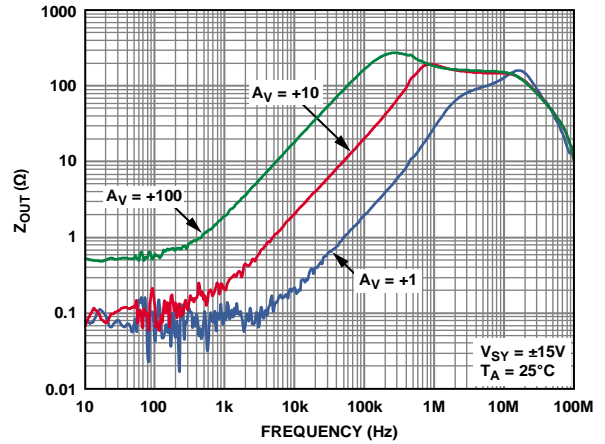

Figure 87. Output Impedance ( $Z_{OUT}$ ) vs. Frequency

08237-059

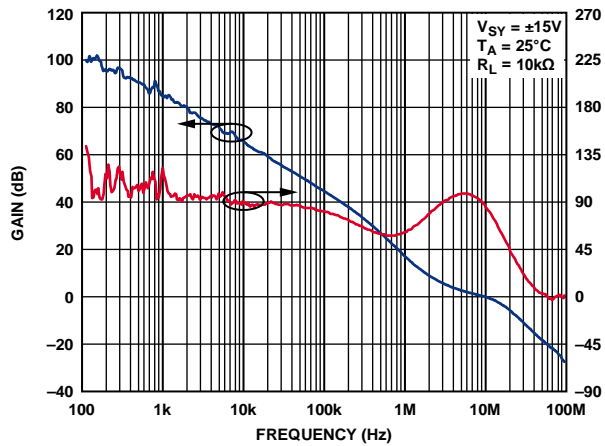

Figure 85. Open-Loop Gain and Phase vs. Frequency

08237-057

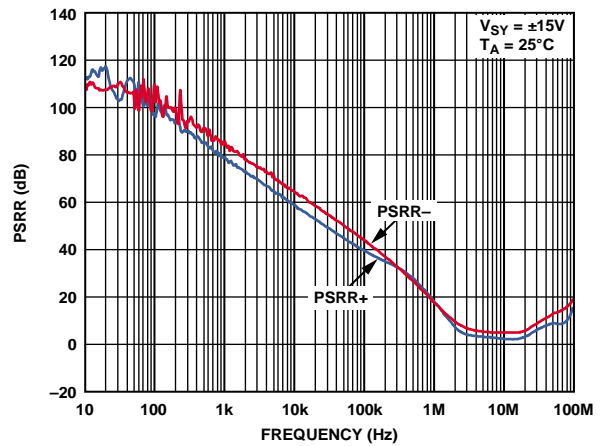

Figure 88. PSRR vs. Frequency

08237-060

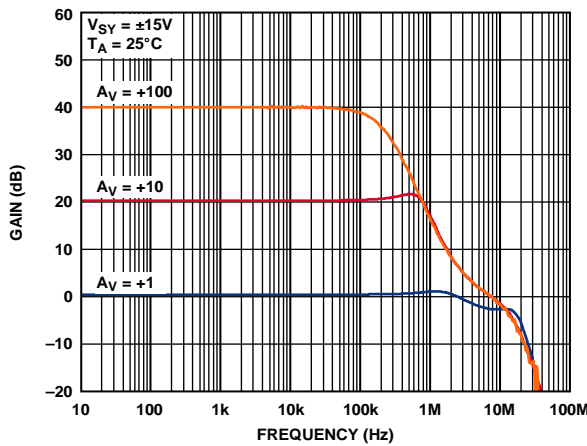

Figure 86. Closed-Loop Gain vs. Frequency

08237-058

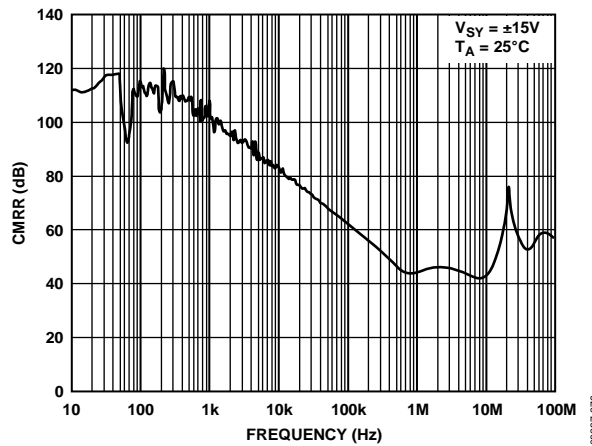

Figure 89. CMRR vs. Frequency

08237-079

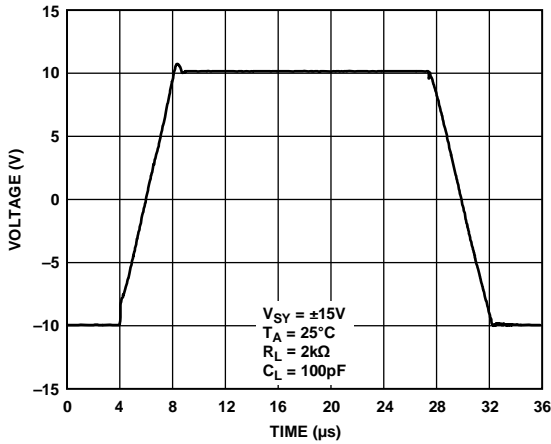

Figure 90. Large Signal Transient Response

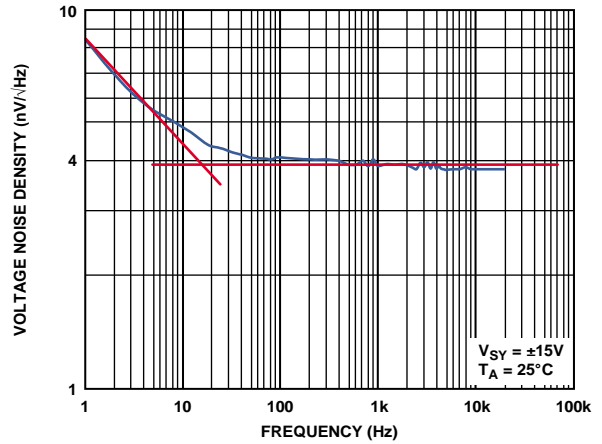

Figure 93. Voltage Noise Density vs. Frequency

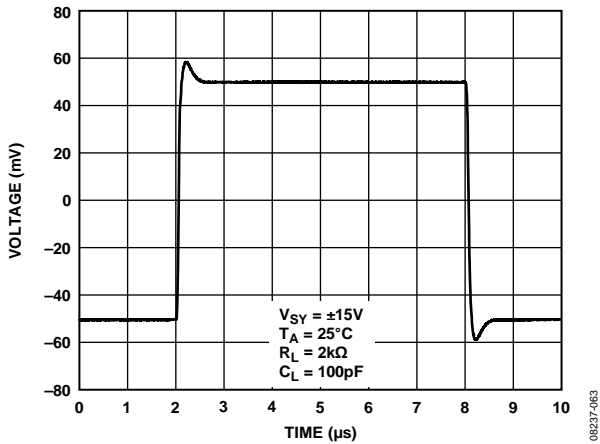

Figure 91. Small Signal Transient Response

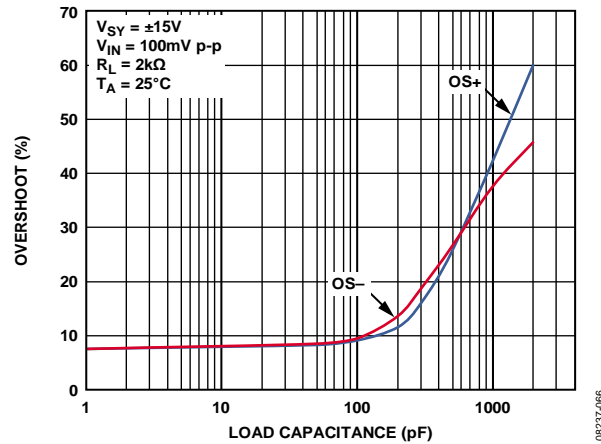

Figure 94. Overshoot vs. Load Capacitance

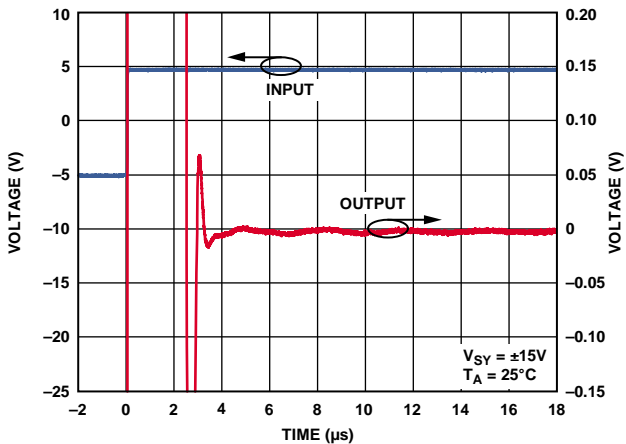

Figure 92. Settling Time

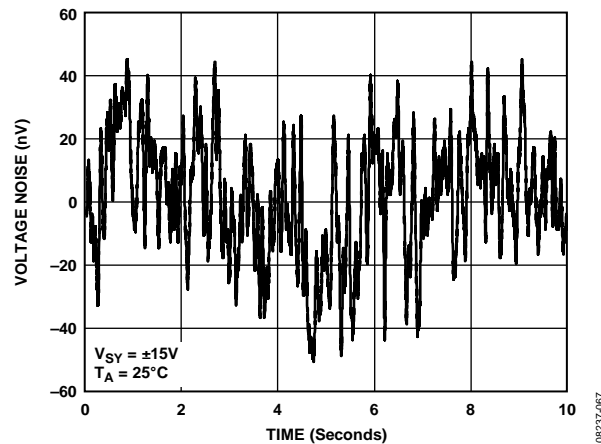

Figure 95. Voltage Noise 0.1 Hz to 10 Hz

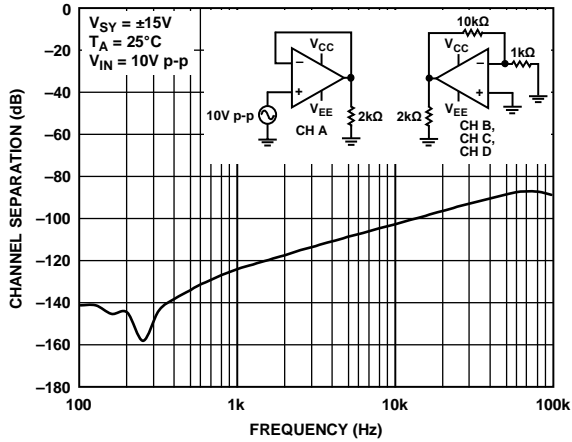

Figure 96. Channel Separation vs. Frequency

08237-068

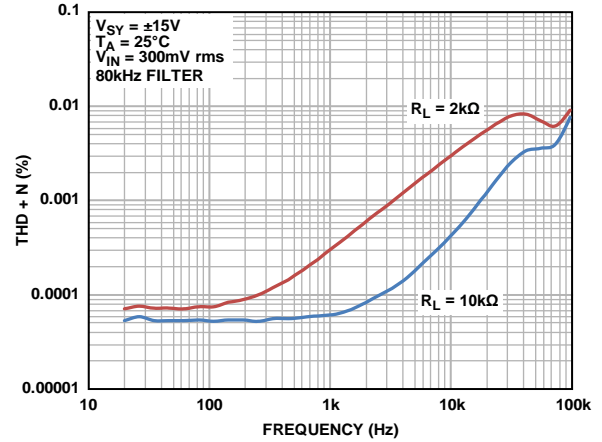

Figure 99. THD + N vs. Frequency, 80 kHz Filter

08237-289

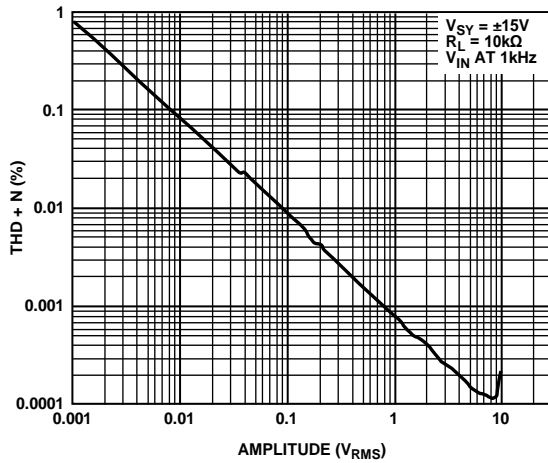

Figure 97. THD + N vs. Amplitude

08237-175

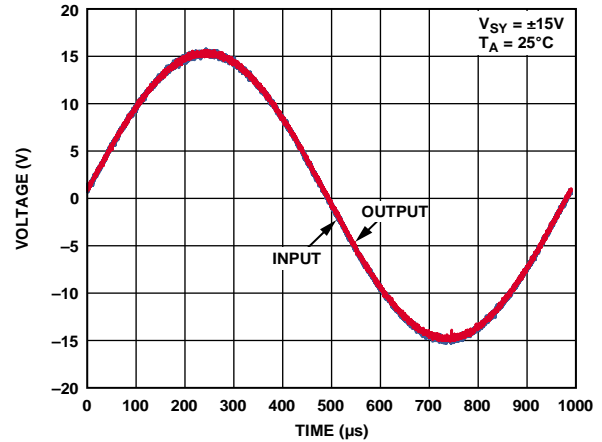

Figure 100. No Phase Reversal

08237-071

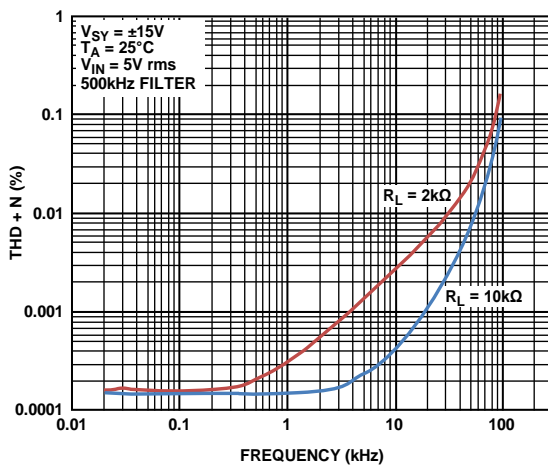

Figure 98. THD + N vs. Frequency, 500 kHz Filter

08237-176

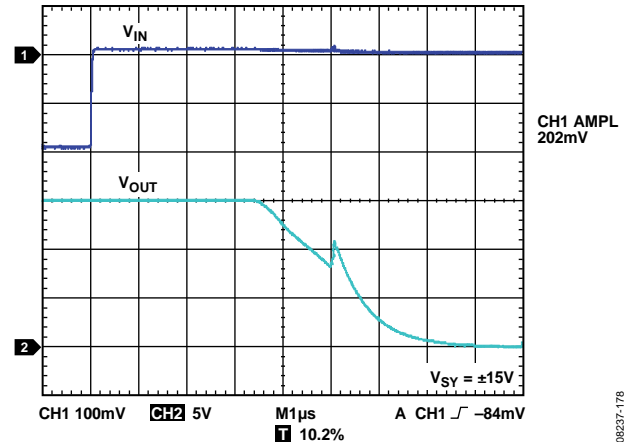

Figure 101. Positive 50% Overload Recovery

08237-178

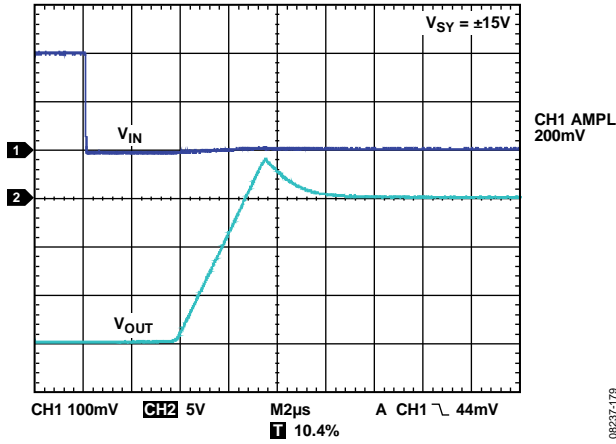

Figure 102. Negative 50% Overload Recovery

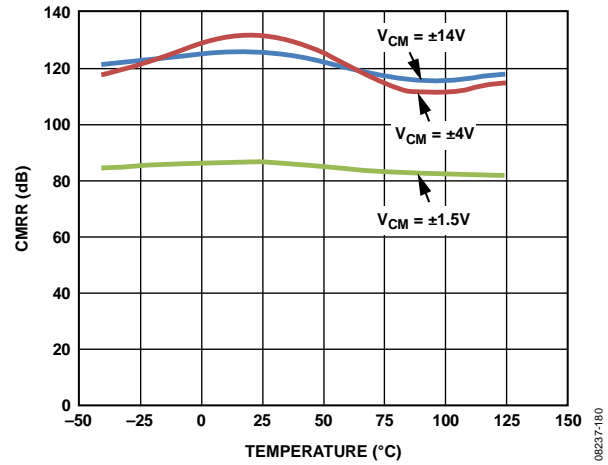

Figure 104. CMRR vs. Temperature

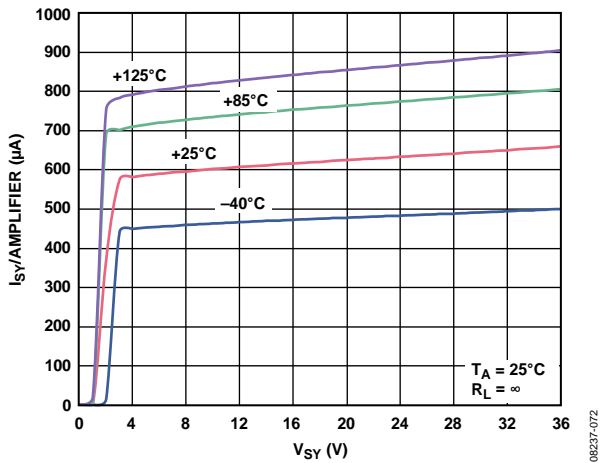

Figure 103. Supply Current ( $I_{SY}$ ) per Amplifier vs. Supply Voltage ( $V_{SY}$ ) for Various Temperatures

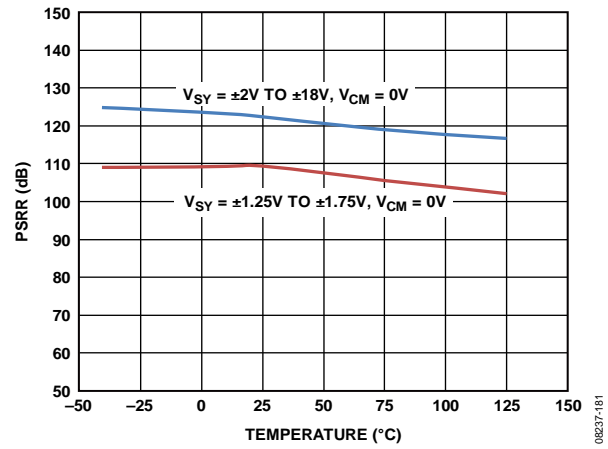

Figure 105. PSRR vs. Temperature

## APPLICATIONS INFORMATION

### FUNCTIONAL DESCRIPTION

The ADA4084-1/ADA4084-2/ADA4084-4 devices are precision single-supply, rail-to-rail operational amplifiers. Intended for portable instrumentation, the ADA4084-1/ADA4084-2/ADA4084-4 devices combine the attributes of precision, wide bandwidth, and low noise, making them an ideal choice in single-supply applications that require both ac and precision dc performance. Other low supply voltage applications for which the ADA4084-1/ADA4084-2/ADA4084-4 devices are well suited include active filters, audio microphone preamplifiers, power supply control, and telecommunications. To combine all of these attributes with rail-to-rail input/output operation, novel circuit design techniques are used.

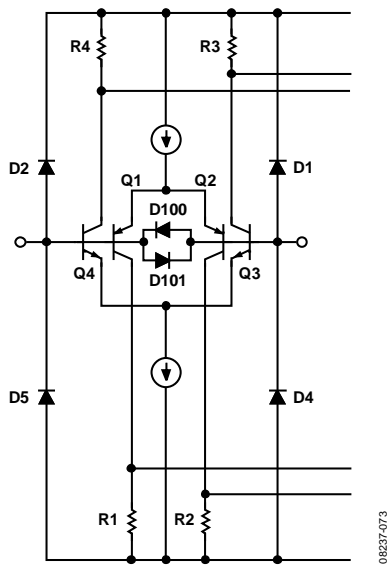

Figure 106. Equivalent Input Circuit

For example, Figure 106 illustrates a simplified equivalent circuit for the input stage of the ADA4084-1/ADA4084-2/ADA4084-4. It comprises a PNP differential pair, Q1 and Q2, and an NPN differential pair, Q3 and Q4, operating concurrently. Diode D100 and Diode D101 serve to clamp the applied differential input voltage to the ADA4084-1/ADA4084-2/ADA4084-4, thereby protecting the input transistors against Zener breakdown of the emitter-base junctions. Input stage voltage gains are kept low for input rail-to-rail operation. The two pairs of differential output voltages are connected to the second stage of the ADA4084-1/ADA4084-2/ADA4084-4, which is a modified compound folded cascade gain stage. It is also in the second gain stage that the two pairs of differential output voltages are combined into a single-ended output signal voltage used to drive the output stage.

A key issue in the input stage is the behavior of the input bias currents over the input common-mode voltage range. Input bias currents in the ADA4084-1/ADA4084-2/ADA4084-4 are the arithmetic sum of the base currents in Q1 and Q4 and in Q2 and Q3. As a result, of this design approach, the input bias currents in the ADA4084-1/ADA4084-2/ADA4084-4 not only exhibit different amplitudes but they also exhibit different polarities. This effect is best illustrated by Figure 19, Figure 20, Figure 50, Figure 51, Figure 81, and Figure 82. It is, therefore, important that the effective source impedances that are connected to the ADA4084-1/ADA4084-2/ADA4084-4 inputs be balanced for optimum dc and ac performance.

To achieve rail-to-rail output, the ADA4084-1/ADA4084-2/ADA4084-4 output stage design employs a unique topology for both sourcing and sinking current. This circuit topology is shown in Figure 107. The output stage is voltage driven from the second gain stage. The signal path through the output stage is inverting; that is, for positive input signals, Q13 provides the base current drive to Q19 so that it conducts (sinks) current. For negative input signals, the signal path via Q18 → mirror → Q24 provides the base current drive for Q23 to conduct (source) current. Both transistors provide output current until they are forced into saturation.

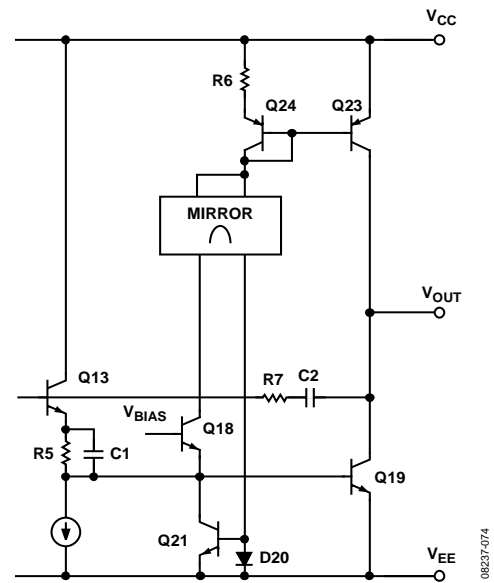

Figure 107. Equivalent Output Circuit

Thus, the saturation voltage of the output transistors sets the limit on the ADA4084-1/ADA4084-2/ADA4084-4 maximum output voltage swing. Output short-circuit current limiting is determined by the maximum signal current into the base of Q13 from the second gain stage. The output stage also exhibits voltage gain. This is accomplished by the use of common-emitter amplifiers, and, as a result, the voltage gain of the output stage (thus, the open-loop gain of the device) exhibits a dependence on the total load resistance at the output of the ADA4084-1/ADA4084-2/ADA4084-4.

## START-UP CHARACTERISTICS

The ADA4084-1/ADA4084-2/ADA4084-4 are specified to operate from 3 V to 30 V ( $\pm 1.5$  V to  $\pm 15$  V) under nominal power supplies. During power-up as the supply voltage increases from 0 V to the nominal power supply voltage, the supply current ( $I_{SY}$ ) increases as well, to the point at which it stabilizes and the amplifier is ready to operate. The stabilization varies with temperature, as shown in Figure 103. For example, at  $-40^{\circ}\text{C}$ , it requires a higher voltage and stabilizes at a lower supply current than at hot temperatures. At hot temperatures, it requires a lower voltage but stabilizes at a higher current. In all cases, the ADA4084-1/ADA4084-2/ADA4084-4 are specified to start up and operate at a minimum of 3 V under all temperature conditions.

## INPUT PROTECTION

As with any semiconductor device, if conditions exist where the applied input voltages to the device exceed either supply voltage, the input overvoltage I-to-V characteristic of the device must be considered. When an overvoltage occurs, the amplifier may be damaged, depending on the magnitude of the applied voltage and the magnitude of the fault current.

The D1, D2, D4, and D5 diodes conduct when the input common-mode voltage exceeds either supply pin by a diode drop. This diode drop voltage varies with temperature and is in the range of 0.3 V to 0.8 V. As shown in the simplified equivalent input circuit of Figure 106, the ADA4084-1/ADA4084-2/ADA4084-4 do not have any internal current limiting resistors; thus, fault currents can quickly rise to damaging levels.

This input current is not inherently damaging to the device, provided that it is limited to 5 mA or less. If a fault condition causes more than 5 mA to flow, add an external series resistor at the expense of additional thermal noise. Figure 108 shows a typical noninverting configuration for an overvoltage protected amplifier, where the series resistance ( $R1$ ) is chosen, such that

$$R1 = \frac{V_{IN(MAX)} - V_{SUPPLY}}{5 \text{ mA}}$$

For example, a 1 k $\Omega$  resistor protects the ADA4084-1/ADA4084-2/ADA4084-4 against input signals up to 5 V above and below the supplies. Note that the thermal noise of a 1 k $\Omega$  resistor at room temperature is 4 nV/ $\sqrt{\text{Hz}}$ , which exceeds the voltage noise of the ADA4084-1/ADA4084-2/ADA4084-4. For other configurations in which both inputs are used, add a series resistor to limit the input current. To ensure optimum dc and ac performance, balance the source impedance levels.

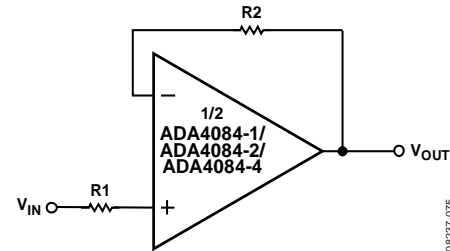

Figure 108. Resistance in Series with the Input Limits Overvoltage Currents to Safe Values

To protect the Q1/Q2 and Q3/Q4 pairs from large differential voltages that may result in Zener breakdown of the emitter-base junction, D100 and D101 are connected between the two inputs. This precludes operation as a comparator. For a more complete description, see the MT-035 Tutorial, *Op Amp Inputs, Outputs, Single-Supply, and Rail-to-Rail Issues*; the MT-083 Tutorial, *Comparators*; the MT-084 Tutorial, *Using Op Amps as Comparators*; and the AN-849 Application Note, *Using Op Amps as Comparators*.

## OUTPUT PHASE REVERSAL

Some operational amplifiers designed for single-supply operation exhibit an output voltage phase reversal when their inputs are driven beyond their useful common-mode range. Typically, for single-supply bipolar op amps, the negative supply determines the lower limit of their common-mode range. With these devices, external clamping diodes, with the anode connected to ground and the cathode to the inputs, prevent input signal excursions from exceeding the negative supply of the device (that is, GND), preventing a condition that causes the output voltage to change phase. JFET input amplifiers can also exhibit phase reversal, and, if so, a series input resistor is usually required to prevent it.

The ADA4084-1/ADA4084-2/ADA4084-4 are free from reasonable input voltage range restrictions, provided that input voltages no greater than the supply voltages are applied (see Figure 38, Figure 69, and Figure 100).

Although device output does not change phase, large currents can flow through the input protection diodes. Therefore, apply the technique recommended in the Input Protection section to those applications where the likelihood of input voltages exceeding the supply voltages is high.

**DESIGNING LOW NOISE CIRCUITS IN SINGLE-SUPPLY APPLICATIONS**

In single-supply applications, devices like the [ADA4084-1/ADA4084-2/ADA4084-4](#) extend the dynamic range of the application through the use of rail-to-rail operation. Referring to the op amp noise model circuit configuration illustrated in Figure 109, the expression for the total equivalent input noise voltage of an amplifier for a source resistance level,  $R_s$ , is given by

$$e_{nT} = \sqrt{2[(e_{nR})^2 + (i_{nOA} \times R_s)^2] + (e_{nOA})^2}, \text{ units in } \frac{V}{\sqrt{\text{Hz}}}$$

where:

$(e_{nR})^2$  is the source resistance thermal noise voltage power ( $4kTR$ ).

$k$  is the Boltzmann's constant,  $1.38 \times 10^{-23}$  J/K.

$T$  is the ambient temperature in Kelvin of the circuit,  $273.15 + T_A$  ( $^{\circ}\text{C}$ ).

$(i_{nOA})^2$  is the op amp equivalent input noise current spectral power (1 Hz bandwidth).

$R_s = 2R$ , the effective, or equivalent, circuit source resistance.

$(e_{nOA})^2$  is the op amp equivalent input noise voltage spectral power (1 Hz bandwidth).

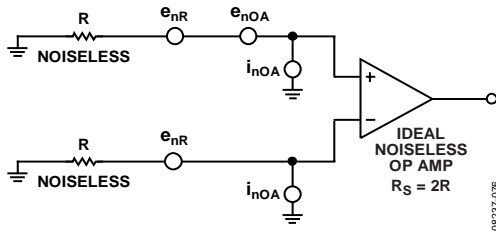

Figure 109. Op Amp Noise Circuit Model Used to Determine Total Circuit Equivalent Input Noise Voltage and Noise Figure

As a design aid, Figure 110 shows the equivalent thermal noise of the [ADA4084-1/ADA4084-2/ADA4084-4](#) vs. the total source resistance. Note that for source resistance less than 1 k $\Omega$ , the equivalent input noise voltage of the [ADA4084-1/ADA4084-2/ADA4084-4](#) is dominant.

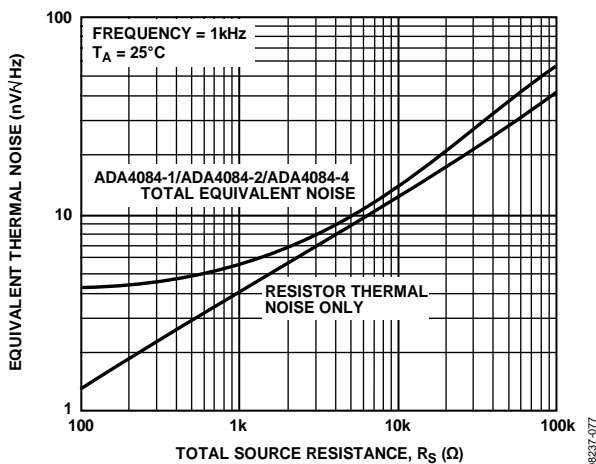

Figure 110. Equivalent Thermal Noise vs. Total Source Resistance

Because circuit SNR is the critical parameter in the final analysis, the noise behavior of a circuit is sometimes expressed in terms of its noise figure (NF). The noise figure is defined as the ratio of the signal-to-noise output of a circuit to its signal-to-noise input.

Noise figure is generally used for RF and microwave circuit analysis in a 50  $\Omega$  system. This is not very useful for op amp circuits where the input and output impedances can vary greatly. For a more complete description of noise figure, see the [MT-052 Tutorial, Op Amp Noise Figure: Don't be Misled](#).

Signal levels in the application invariably increase to maximize circuit SNR, which is not an option in low voltage, single-supply applications.

Therefore, to achieve optimum circuit SNR in single-supply applications, choose an operational amplifier with the lowest equivalent input noise voltage, along with source resistance levels that are consistent with maintaining low total circuit noise.

**COMPARATOR OPERATION**

Although op amps are quite different from comparators, occasionally an unused section of a dual or a quad op amp can be used as a comparator; however, this is not recommended for any rail-to-rail output op amps. For rail-to-rail output op amps, the output stage is generally a ratioed current mirror with bipolar or MOSFET transistors. With the device operating open loop, the second stage increases the current drive to the ratioed mirror to close the loop. However, the loop cannot close, which results in an increase in supply current. With the op amp configured as a comparator, the supply current can be significantly higher (see Figure 111). Configure an unused section as a voltage follower with the noninverting input connected to a voltage within the input voltage range. The [ADA4084-1/ADA4084-2/ADA4084-4](#) have unique second stage and output stage designs that greatly reduce the excess supply current when the op amp is operating open loop.

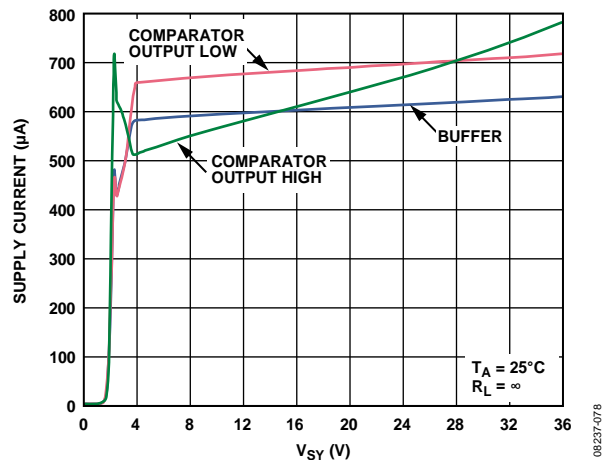
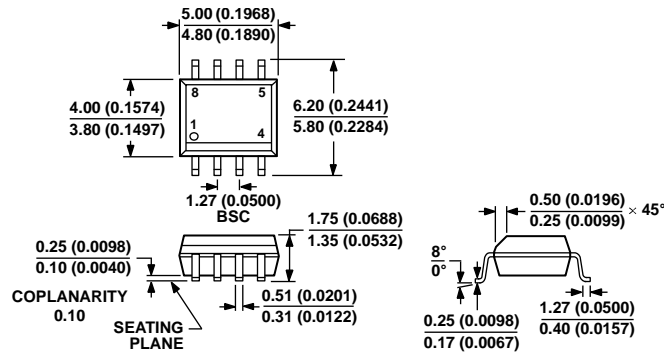

Figure 111. Supply Current vs. Supply Voltage ( $V_{SV}$ )

OUTLINE DIMENSIONS



COMPLIANT TO JEDEC STANDARDS MS-012-AA  
 CONTROLLING DIMENSIONS ARE IN MILLIMETERS; INCH DIMENSIONS  
 (IN PARENTHESES) ARE ROUNDED-OFF MILLIMETER EQUIVALENTS FOR  
 REFERENCE ONLY AND ARE NOT APPROPRIATE FOR USE IN DESIGN.

012407-A

Figure 112. 8-Lead Standard Small Outline Package [SOIC\_N]  
 Narrow Body  
 (R-8)

Dimensions shown in millimeters and (inches)

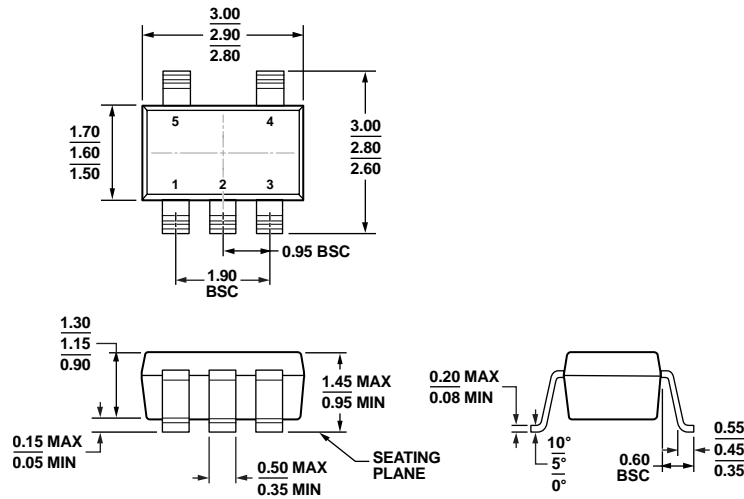

COMPLIANT TO JEDEC STANDARDS MO-178-AA

Figure 113. 5-Lead Small Outline Transistor Package [SOT-23]  
 (RJ-5)

Dimensions shown in millimeters

11-01-2010-A



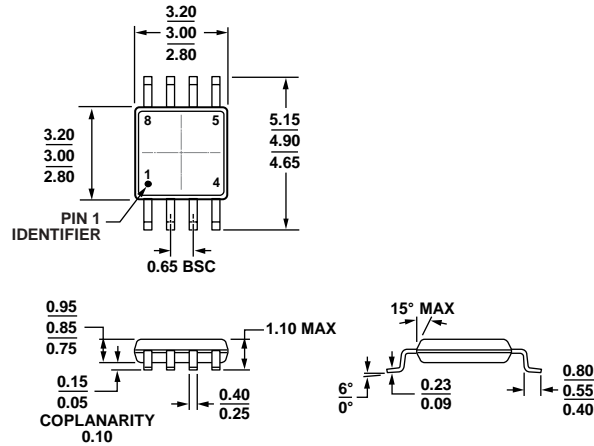

COMPLIANT TO JEDEC STANDARDS MO-187-AA

Figure 114. 8-Lead Mini Small Outline Package [MSOP] (RM-8)

Dimensions shown in millimeters

10-07-2008-B

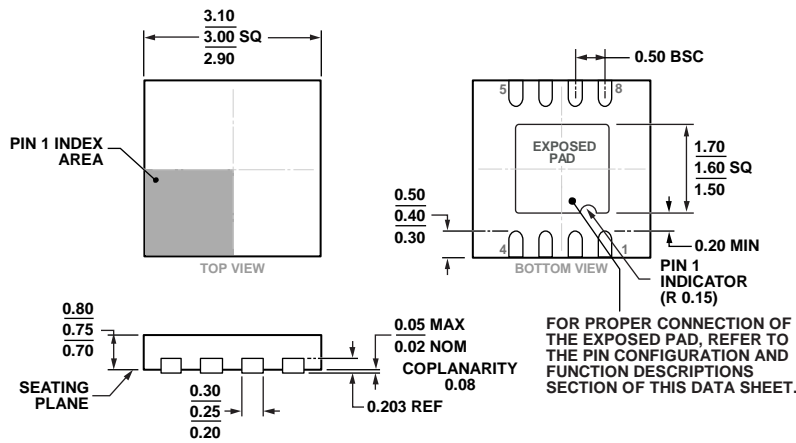

COMPLIANT TO JEDEC STANDARDS MO-229-WEED

Figure 115. 8-Lead Lead Frame Chip Scale Package [LFCSF\_WD] 3 mm x 3 mm Body, Very Very Thin, Dual Lead (CP-8-12)

Dimensions shown in millimeters

02-05-2013-B

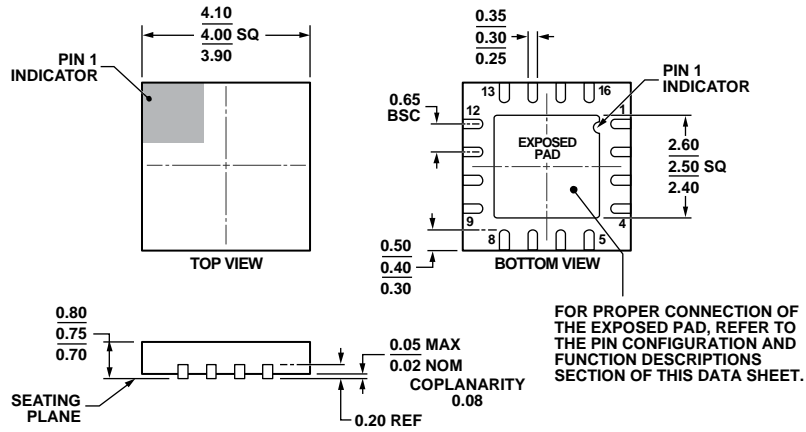

COMPLIANT TO JEDEC STANDARDS MO-220-WGGC.

Figure 116. 16-Lead Lead Frame Chip Scale Package [LF CSP\_WQ]  
 4 mm × 4 mm Body, Very Very Thin Quad  
 (CP-16-26)  
 Dimensions shown in millimeters

042709-A

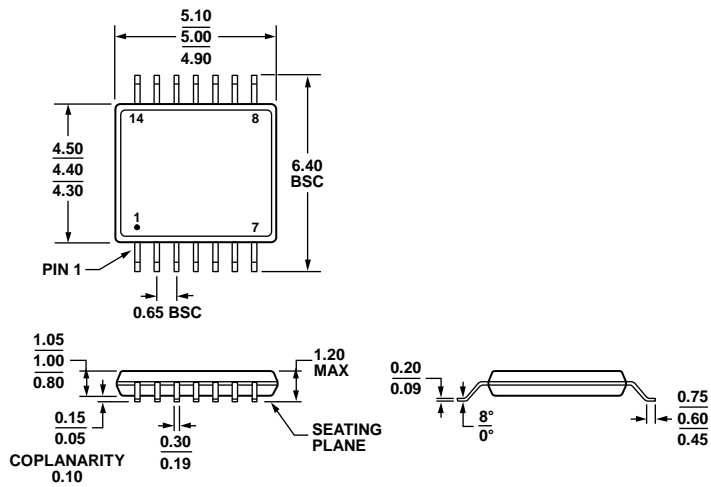

COMPLIANT TO JEDEC STANDARDS MO-153-AB-1

Figure 117. 14-Lead Thin Shrink Small Outline Package [TSSOP]  
 (RU-14)  
 Dimensions shown in millimeters

061908-A

## ORDERING GUIDE

Model <sup>1</sup>	Temperature Range	Package Description	Package Option	Branding
ADA4084-1ARZ	-40°C to +125°C	8-Lead Standard Small Outline Package [SOIC_N]	R-8	
ADA4084-1ARZ-R7	-40°C to +125°C	8-Lead Standard Small Outline Package [SOIC_N]	R-8	
ADA4084-1ARZ-RL	-40°C to +125°C	8-Lead Standard Small Outline Package [SOIC_N]	R-8	
ADA4084-1ARJZ-R2	-40°C to +125°C	5-Lead Small Outline Transistor Package [SOT-23]	RJ-5	A38
ADA4084-1ARJZ-R7	-40°C to +125°C	5-Lead Small Outline Transistor Package [SOT-23]	RJ-5	A38
ADA4084-1ARJZ-RL	-40°C to +125°C	5-Lead Small Outline Transistor Package [SOT-23]	RJ-5	A38
ADA4084-2ARMZ	-40°C to +125°C	8-Lead Mini Small Outline Package [MSOP]	RM-8	A2Q
ADA4084-2ARMZ-R7	-40°C to +125°C	8-Lead Mini Small Outline Package [MSOP]	RM-8	A2Q
ADA4084-2ARMZ-RL	-40°C to +125°C	8-Lead Mini Small Outline Package [MSOP]	RM-8	A2Q
ADA4084-2ARZ	-40°C to +125°C	8-Lead Standard Small Outline Package [SOIC_N]	R-8	
ADA4084-2ARZ-R7	-40°C to +125°C	8-Lead Standard Small Outline Package [SOIC_N]	R-8	
ADA4084-2ARZ-RL	-40°C to +125°C	8-Lead Standard Small Outline Package [SOIC_N]	R-8	
ADA4084-2ACPZ-R7	-40°C to +125°C	8-Lead Lead Frame Chip Scale Package [LFCSP_WD]	CP-8-12	A2Q
ADA4084-2ACPZ-RL	-40°C to +125°C	8-Lead Lead Frame Chip Scale Package [LFCSP_WD]	CP-8-12	A2Q
ADA4084-4ACPZ-R7	-40°C to +125°C	16-Lead Lead Frame Chip Scale Package [LFCSP_WQ]	CP-16-26	
ADA4084-4ACPZ-RL	-40°C to +125°C	16-Lead Lead Frame Chip Scale Package [LFCSP_WQ]	CP-16-26	
ADA4084-4ARUZ	-40°C to +125°C	14-Lead Thin Shrink Small Outline Package [TSSOP]	RU-14	
ADA4084-4ARUZ-RL	-40°C to +125°C	14-Lead Thin Shrink Small Outline Package [TSSOP]	RU-14	

<sup>1</sup> Z = RoHS Compliant Part.

# Mouser Electronics

Authorized Distributor

Click to View Pricing, Inventory, Delivery & Lifecycle Information:

## Analog Devices Inc.:

[ADA4084-2ARMZ](#) [ADA4084-2ARMZ-R7](#) [ADA4084-2ARZ](#) [ADA4084-2ARZ-R7](#) [ADA4084-2ACPZ-R7](#) [ADA4084-2ACPZ-RL](#) [ADA4084-2ARMZ-RL](#) [ADA4084-2ARZ-RL](#) [ADA4084-4ARUZ](#) [ADA4084-1ARZ](#) [ADA4084-4ARUZ-RL](#) [ADA4084-4ACPZ-RL](#) [ADA4084-4ACPZ-R7](#) [ADA4084-1ARZ-RL](#) [ADA4084-1ARZ-R7](#) [ADA4084-1ARJZ-R2](#) [ADA4084-1ARJZ-RL](#) [ADA4084-1ARJZ-R7](#)