

### Description

The AH5795 is a single chip solution for driving single-coil brushless direct current (BLDC) fans and motors. The integrated full-bridge driver output stage uses soft switching to minimize audible switching noise and electromagnetic interference (EMI) providing a low noise solution.

Motor speed can be controlled by either changing the duty ratio of the PWM signal at the PWM pin or by varying the supply voltage at Vdd pin.

To help protect the motor coil, the AH5795 provides Rotor Lock Protection which shuts down the output drive if rotor lock is detected. The device automatically re-starts when the rotor lock is removed. Over temperature shutdown provides thermal protection for the device.

A Tachometer output is provided by open-drain Frequency Generator (FG) Pin which allows external interface to monitor motor rotation or speed. The FG output is the magnetic change frequency.

The AH5795 is available in space saving and low profile TSOT23-6 and DFN2020C-6 packages.

### Features

- Supports single-coil full-wave BLDC fan drivers
- Built-in Hall sensor and input amplifier
- Operating voltage: 1.8V to 6V
- Speed control methods
  - Vdd voltage speed control (PWM pin tied to Vdd)
  - PWM signal speed control via PWM pin
- Soft switching for low noise DC fan motor applications
- Rotor Lock Protection (Lock detection, output shutdown and automatic re-start)
- Toff clear when PWM is low for greater than 65ms
- Thermal protection
- Tachometer (FG) output
- No external timing capacitor - Reduces the numbers of external components required
- Low profile package: TSOT23-6 and DFN2020C-6
- "Green" Molding Compound (No Br, Sb) (Note 1)

Notes: 1. EU Directive 2002/95/EC (RoHS). All applicable RoHS exemptions applied. Please visit our website at [http://www.diodes.com/products/lead\\_free.html](http://www.diodes.com/products/lead_free.html).

### Pin Assignments

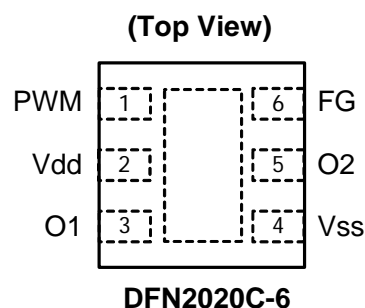
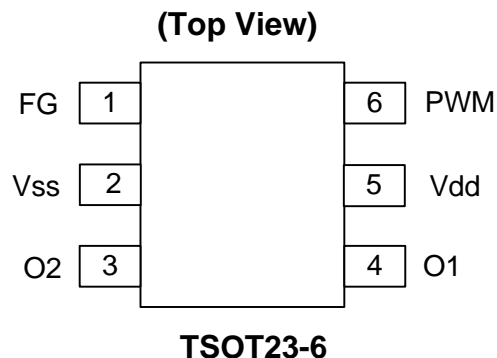

### Applications

- 3.3V / 5V BLDC Cooling Fans
- Netbook/ Notebook BLDC fans
- Instruments cooling fans
- Low Voltage/ Low Power BLDC Motors

**Typical Application Circuit**

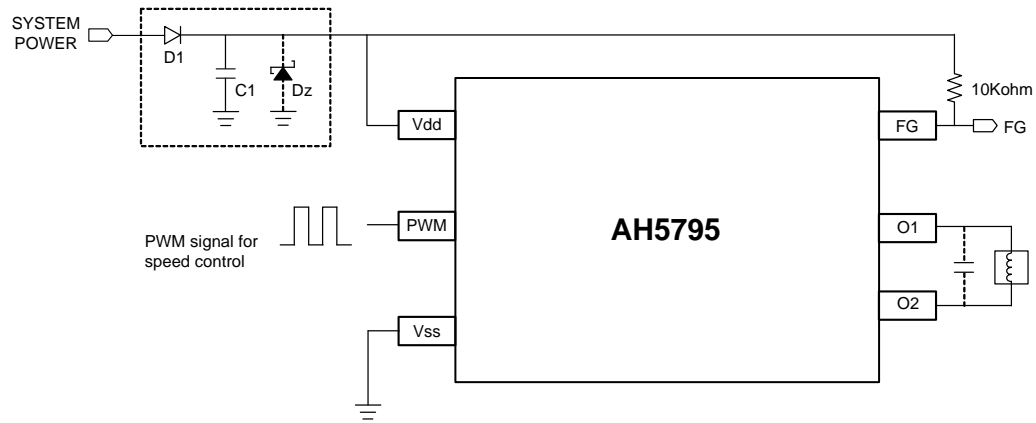

**Pin Descriptions**

| Pin Name        | Description                            |
|-----------------|--|
| V <sub>dd</sub> | Power supply pin                       |
| V <sub>SS</sub> | Ground pin                             |
| O1              | Output driving & sinking pin           |
| O2              | Output driving & sinking pin           |
| PWM             | PWM signal input pin for speed control |
| FG              | Frequency Generator (Note 2)           |

Notes: 2. The FG output is the same as the magnetic change frequency.

**Functional Block Diagram (Note 3)**

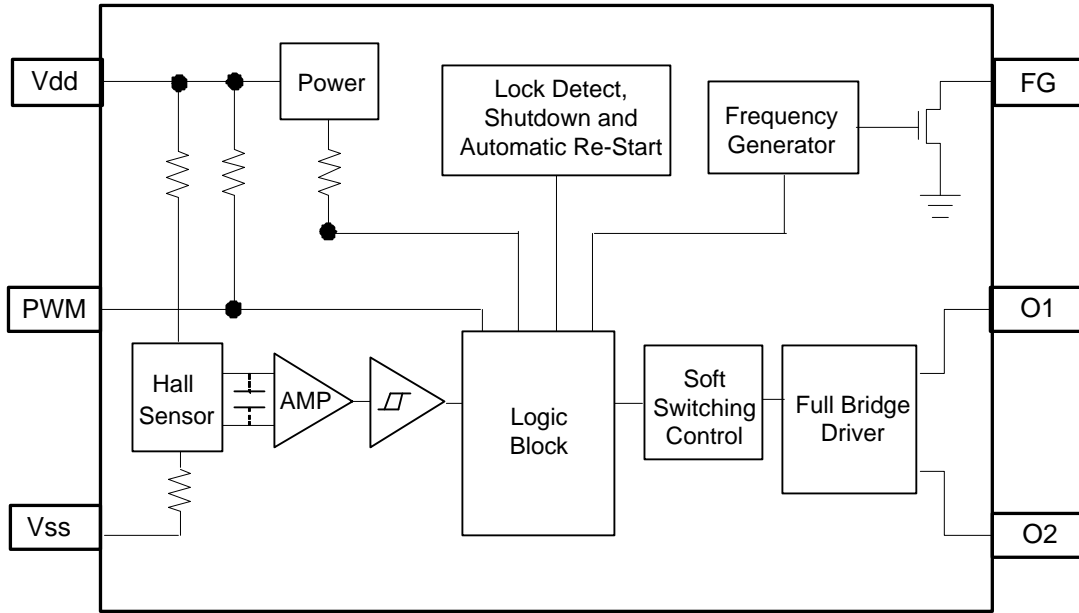

Notes: 3. The AH5795 has an open-drain tachometer FG output that follows the magnetic change frequency. Typically a pull-up resistor of 10KΩ is recommended from FG pin to the supply voltage.

### Absolute Maximum Ratings ( $T_A = 25^\circ\text{C}$ , unless otherwise noted, Note 4)

| Symbol               | Characteristics                       | Values     | Unit         |
|----------------------|---------------------------------------|------------|--------------|
| V <sub>DD</sub>      | Supply voltage                        | 7          | V            |
| I <sub>O(PEAK)</sub> | Maximum Output Current (Peak)         | 1000mA     | mA           |
| P <sub>D</sub>       | Power Dissipation                     | TSOT23-6   | 650          |
|                      |                                       | DFN2020C-6 | 780 (Note 5) |
| T <sub>ST</sub>      | Storage Temperature Range             | -65 ~ 150  | °C           |
| ESD HBM              | Human Body Model (HBM) ESD Protection | 4          | kV           |

- Notes:
- Stresses greater than the 'Absolute Maximum Ratings' specified above, may cause permanent damage to the device. These are stress ratings only; functional operation of the device at these or any other conditions exceeding those indicated in this specification is not implied. Device reliability may be affected by exposure to absolute maximum rating conditions for extended periods of time
  - DFN2020C-6 exposed pad soldered to minimum recommended landing pads (see Package Outline Dimension section) on a two-layer 2oz. copper FR4 PCB (1.6mm thickness) with no thermal vias in exposed PADS or any copper flood connecting to the landing pattern of the exposed pad.

### Recommended Operating Conditions ( $T_A = 25^\circ\text{C}$ )

| Symbol          | Parameter                           | Conditions | Min | Max | Unit |
|-----------------|-------------------------------------|------------|-----|-----|------|
| V <sub>DD</sub> | Supply Voltage                      | Operating  | 1.8 | 6.0 | V    |
| T <sub>A</sub>  | Operating Ambient Temperature Range | Operating  | -40 | 105 | °C   |

### Electrical Characteristics ( $T_A = 25^\circ\text{C}$ , V<sub>DD</sub> = 5V)

| Symbol                  | Characteristics                                     | Conditions                         | Min                 | Typ. | Max                  | Unit |
|-------------------------|---|------------------------------------|---------------------|------|----------------------|------|
| I <sub>DD</sub>         | Supply Current                                      | No Load                            | -                   | 2.2  | -                    | mA   |
| V <sub>OH</sub>         | Output Voltage High                                 | I <sub>OUT</sub> = 300mA           | 4.70                | 4.88 | -                    | V    |
|                         |   | I <sub>OUT</sub> = 500mA           | 4.5                 | 4.8  | -                    | V    |
| V <sub>OL</sub>         | Output Voltage Low                                  | I <sub>OUT</sub> = 300mA           | -                   | 0.12 | 0.3                  | V    |
|                         |   | I <sub>OUT</sub> = 500mA           | -                   | 0.2  | 0.5                  | V    |
| V <sub>oh+Vol</sub>     | Output voltage of N- and PMOS combined              | I <sub>OUT</sub> = 300mA           | -                   | 0.3  | 0.6                  | V    |
|                         |   | I <sub>OUT</sub> = 500mA           | -                   | 0.5  | -                    | V    |
| T <sub>SW</sub>         | Output Switching Slope Duration                     | 17Ω load on out1/out2              | -                   | 200  | -                    | μs   |
| I <sub>LEAK</sub>       | FG Output Leakage Current                           |                                    | -                   | -    | 5                    | μA   |
| V <sub>FGOL</sub>       | FG Output Voltage Low                               | I <sub>FG</sub> = 5mA              | -                   | -    | 0.4                  | V    |
| T <sub>ON</sub>         | On Time   |                                    | 350                 | 500  | 650                  | ms   |
| R <sub>DR</sub>         | Duty Ratio  | T <sub>OFF</sub> / T <sub>ON</sub> | -                   | 10   | -                    |      |
| V <sub>PWMH</sub>       | PWM Input H Level                                   |                                    | 0.5 V <sub>DD</sub> | -    | V <sub>DD</sub>      | V    |
| V <sub>PWML</sub>       | PWM Input L Level                                   |                                    | 0                   | -    | 0.14 V <sub>DD</sub> | V    |
| I <sub>PWMH</sub>       | PWM Input current H Level                           | PWM=V <sub>DD</sub>                |                     | 0    |                      | uA   |
| I <sub>PWML</sub>       | PWM Input current L Level                           | PWM=GND                            |                     | -10  |                      | uA   |
| F <sub>PWM</sub>        | PWM Input Frequency                                 |                                    | 0.02                | -    | 50                   | KHz  |
| D <sub>PWM_MIN</sub>    | Output minimum duty ratio                           | Motor rotating;                    | 10%                 |      | 100                  | %    |
| T <sub>J_SDN_TH</sub>   | IC junction temperature thermal shutdown threshold  |                                    |                     | 175  |                      | °C   |
| T <sub>J_SDN_HYST</sub> | IC junction temperature thermal shutdown hysteresis |                                    |                     | 25   |                      | °C   |

**Magnetic Characteristics** ( $T_A = 25^\circ\text{C}$ ,  $V_{dd} = 1.8\text{V}\sim 6\text{V}$ , Note 6)

(1mT = 10 G)

| Symbol   | Parameter     | Min | Typ. | Max | Unit  |
|----------|---------------|-----|------|-----|-------|
| $B_{op}$ | Operate Point | 10  | 25   | 50  | Gauss |
| $B_{rp}$ | Release Point | -50 | -25  | -10 |       |
| $B_{hy}$ | Hysteresis    | -   | 50   | -   |       |

Notes: 6. Magnetic characteristics may vary with supply voltage, operating temperature and after soldering.

**Operating Characteristics**

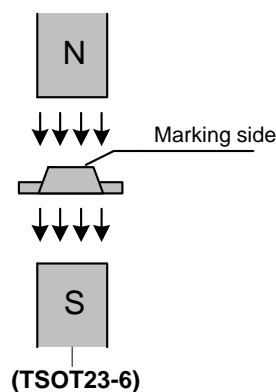
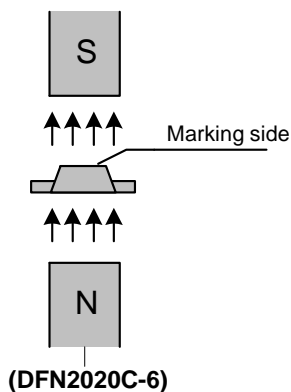
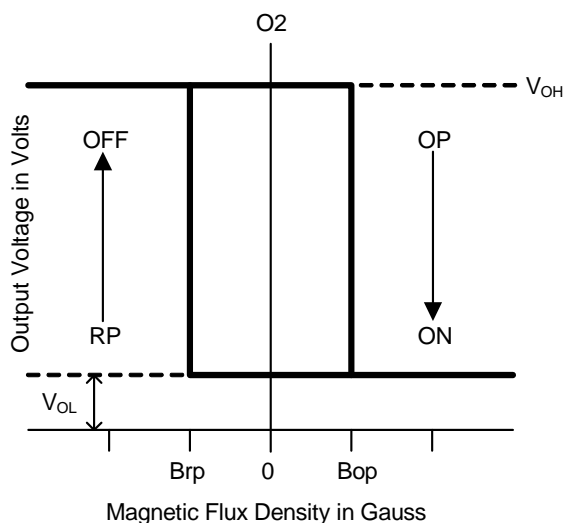
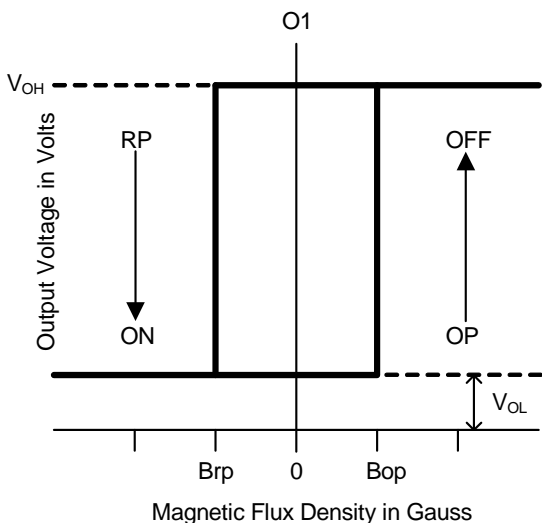

**Operating Characteristics (cont. Note 7, 8, 9 and 10)**

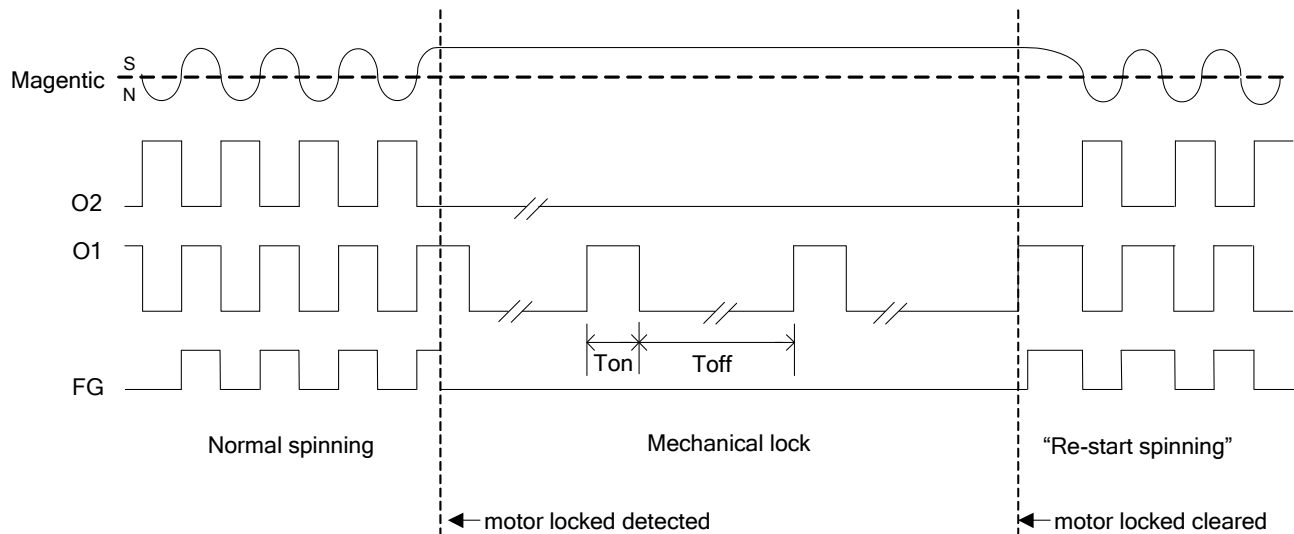

**Truth Table**

| O1 | O2 | PWM | FG          |
|----|----|-----|-------------|
| L  | H  | H   | L           |
| H  | L  | H   | H           |
| L  | L  | L   | X (Note 10) |

- Notes:
- 7. In "Normal spinning, the FG changes its state at each edge of O1.
  - 8. When the motor locks with South pole at the Hall element, O2 is kept on "L" and O1 is a clock with Ton/Toff ratio. When motor locks with North pole at the Hall element, O1 is kept on "L", O2 is a clock with Ton/Toff ratio.
  - 9. When "Re-start spinning" occurs, the motor speed ramps up to the "Normal Spinning" speed from zero. Speed ramp-up profile depends on motor characteristics.
  - 10. X: H or L depends on magnetic pole north or South

**Application Note**

**DC Supply voltage speed control**

Motor speed can be controlled by varying the Vdd supply voltage while PWM pin is tied to Vdd pin.

For example, with 5V nominal motor, changing supply voltage between 5V to 1.8V, speed can be reduced from 100% to 36% typically.

**PWM speed control**

Motor speed can also be adjusted by applying a PWM speed control signal into the PWM pin while keeping the Vdd pin at nominal motor voltage. The motor speed is proportional to the PWM signal duty. For example, with 5V nominal motor, Vdd pin is maintained at 5V typical while varying the PWM control signal duty to adjust the motor speed linearly. Figure below shows the output O1 and O2 in relation to PWM speed control signal at PWM pin.

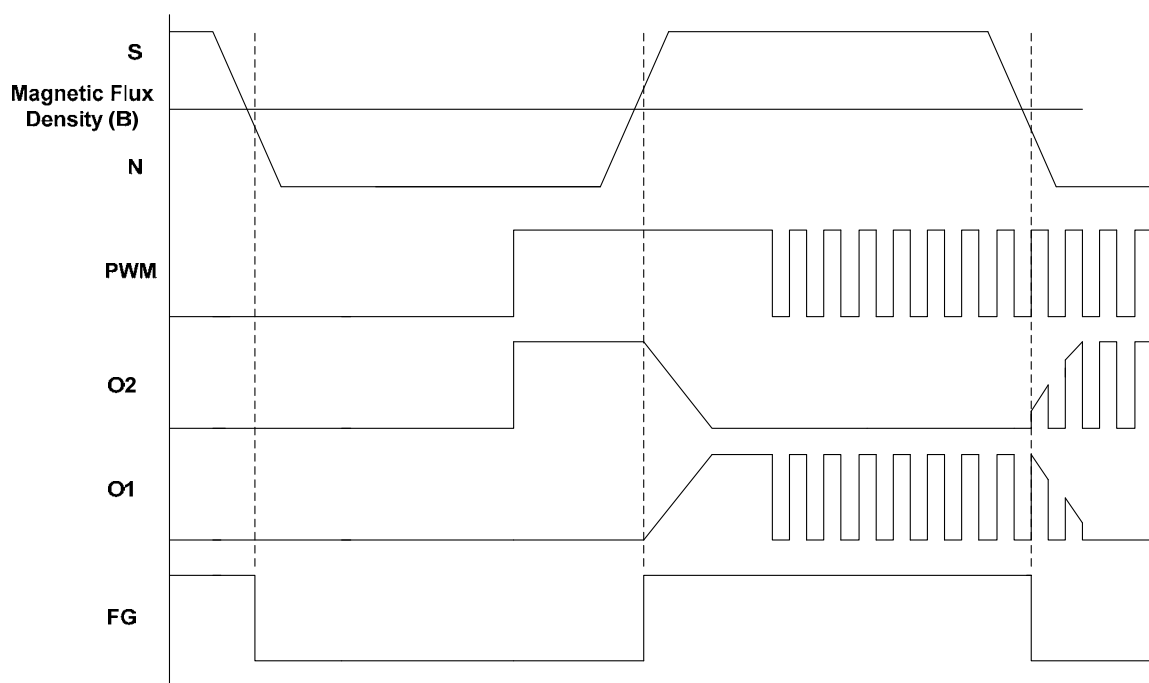

Frequency of PWM speed control signal can be between 15Hz to 50kHz. Recommended typical PWM signal frequency is 25kHz to keep switching frequency away from audible band. If PWM signal level at PWM pin stays low for longer than 65ms typical, the outputs are disabled.

Depending on the motor design and its inertia, minimum start-up PWM duty required can be typically between 30% - 40% while minimum running PWM duty can be down to 20%-25% typical. If voltage at Vdd is lower than the nominal motor voltage, both start-up PWM duty and minimum running PWM duty required will be higher.

**Application Note (cont.)**

**Rotor lock Toff and PWM signal**

When PWM signal input at PWM pin is low for longer than 65ms, internal rotor lock protection Toff is cleared. This allows the device to enter motor start Ton time on the next PWM high signal

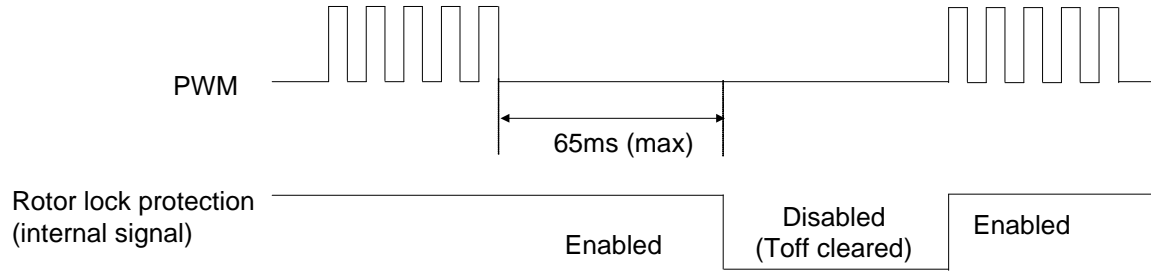

**Soft Switching**

AH5795 uses soft switching of the motor coil current during commutation for to minimize audible switching noise and electromagnetic interference (EMI) to provide a low noise solution.

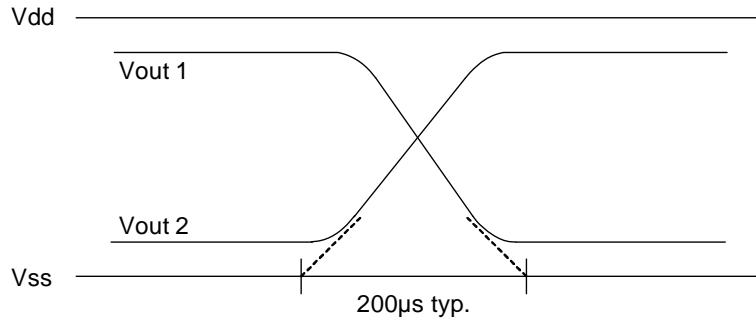



**Thermal Performance Characteristics**

**(1) TSOT23-6**

|            |     |     |     |     |     |     |     |     |     |     |
|------------|-----|-----|-----|-----|-----|-----|-----|-----|-----|-----|
| $T_A$ (°C) | 25  | 50  | 60  | 70  | 75  | 80  | 85  | 90  | 95  | 100 |
| $P_D$ (mW) | 651 | 521 | 469 | 417 | 391 | 365 | 339 | 313 | 286 | 260 |
| $T_A$ (°C) | 105 | 110 | 115 | 120 | 125 | 130 | 135 | 140 | 145 | 150 |
| $P_D$ (mW) | 234 | 208 | 182 | 156 | 130 | 104 | 78  | 52  | 26  | 0   |

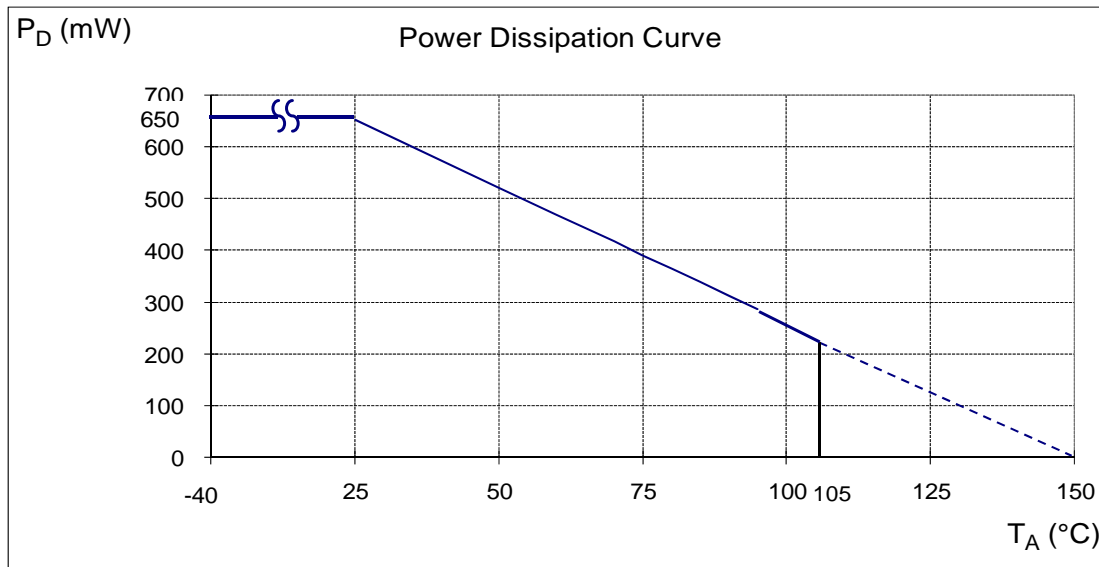

**(2) DFN2020C-6 (Note 11)**

|            |     |     |     |     |     |     |     |     |     |     |
|------------|-----|-----|-----|-----|-----|-----|-----|-----|-----|-----|
| $T_A$ (°C) | 25  | 50  | 60  | 70  | 75  | 80  | 85  | 90  | 95  | 100 |
| $P_D$ (mW) | 781 | 625 | 563 | 500 | 469 | 438 | 406 | 375 | 344 | 313 |
| $T_A$ (°C) | 105 | 110 | 115 | 120 | 125 | 130 | 135 | 140 | 145 | 150 |
| $P_D$ (mW) | 281 | 250 | 219 | 188 | 156 | 125 | 94  | 63  | 31  | 0   |

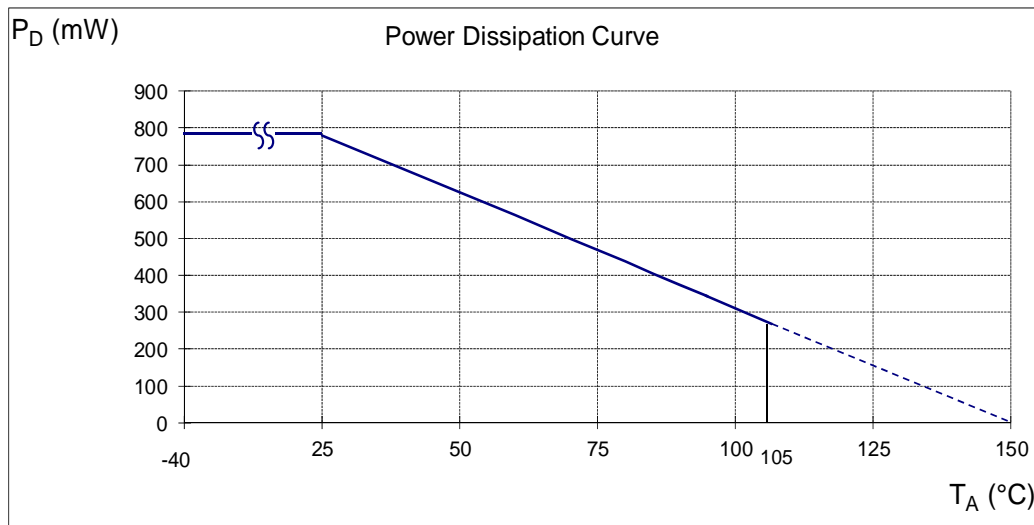

Notes: 11. DFN2020C-6 exposed pad soldered to minimum recommended landing pads (see Package Outline Dimension section) on a two-layer 2oz. copper FR4 PCB (1.6mm thickness) with no thermal vias in exposed PADs or any copper flood connecting to the landing pattern of the exposed pad.

### Ordering information

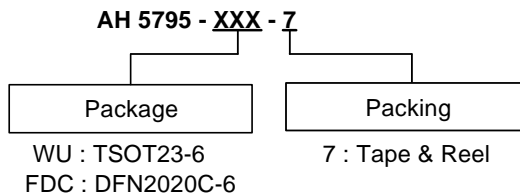

| Device       | Package Code | Packaging (Note 12 & 13) | 7" Tape and Reel |                    |
|--------------|--------------|--------------------------|------------------|--------------------|
|              |              |                          | Quantity         | Part Number Suffix |
| AH5795-WU-7  | WU           | TSOT23-6                 | 3000/Tape & Reel | -7                 |
| AH5795-FDC-7 | FDC          | DFN2020C-6               | 3000/Tape & Reel | -7                 |

Notes: 12. Pad layout as shown on Diodes Inc. suggested pad layout document AP02001, which can be found on our website at <http://www.diodes.com/datasheets/ap02001.pdf>  
 13. EU Directive 2002/95/EC (RoHS). All applicable RoHS exemptions applied. Please visit our website at [http://www.diodes.com/products/lead\\_free.html](http://www.diodes.com/products/lead_free.html)

### Marking Information

#### (1) TSOT23-6

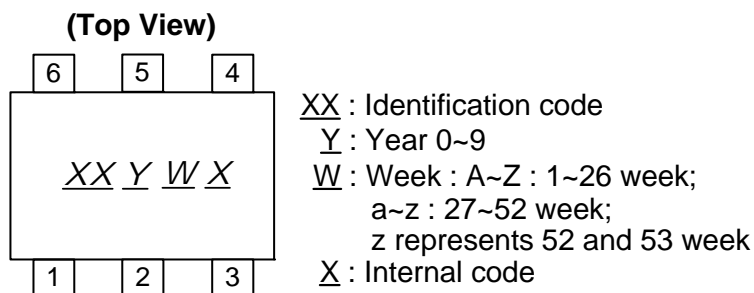

| Part Number | Package  | Identification Code |
|-------------|----------|---------------------|
| AH5795-WU-7 | TSOT23-6 | J5                  |

#### (2) DFN2020C-6

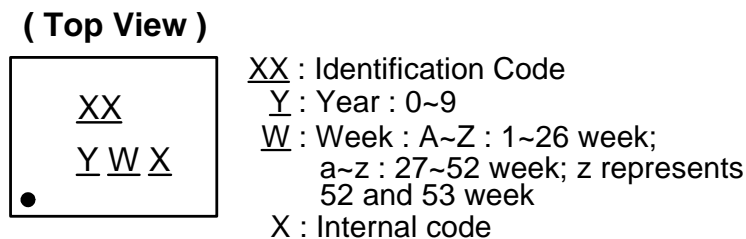

| Part Number  | Package    | Identification Code |
|--------------|------------|---------------------|
| AH5795-FDC-7 | DFN2020C-6 | J5                  |



**Taping Orientation**

For DFN2020C-6

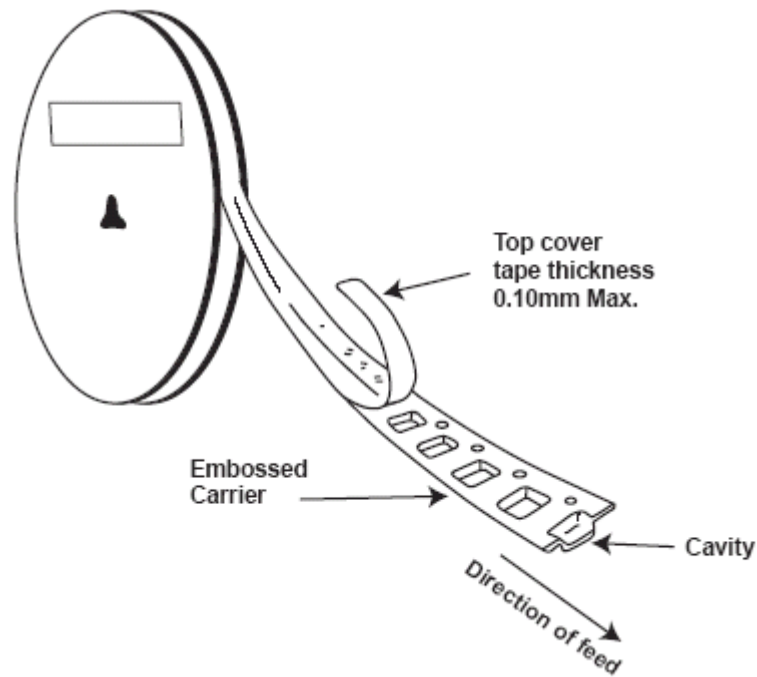
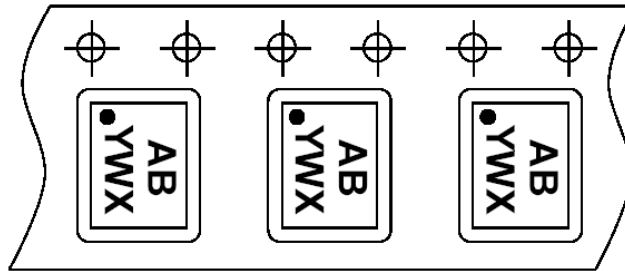

Notes: 14. The taping orientation of the other package type can be found on our website at <http://www.diodes.com/datasheets/ap02007.pdf>.

**IMPORTANT NOTICE**

DIODES INCORPORATED MAKES NO WARRANTY OF ANY KIND, EXPRESS OR IMPLIED, WITH REGARDS TO THIS DOCUMENT, INCLUDING, BUT NOT LIMITED TO, THE IMPLIED WARRANTIES OF MERCHANTABILITY AND FITNESS FOR A PARTICULAR PURPOSE (AND THEIR EQUIVALENTS UNDER THE LAWS OF ANY JURISDICTION).

Diodes Incorporated and its subsidiaries reserve the right to make modifications, enhancements, improvements, corrections or other changes without further notice to this document and any product described herein. Diodes Incorporated does not assume any liability arising out of the application or use of this document or any product described herein; neither does Diodes Incorporated convey any license under its patent or trademark rights, nor the rights of others. Any Customer or user of this document or products described herein in such applications shall assume all risks of such use and will agree to hold Diodes Incorporated and all the companies whose products are represented on Diodes Incorporated website, harmless against all damages.

Diodes Incorporated does not warrant or accept any liability whatsoever in respect of any products purchased through unauthorized sales channel.

Should Customers purchase or use Diodes Incorporated products for any unintended or unauthorized application, Customers shall indemnify and hold Diodes Incorporated and its representatives harmless against all claims, damages, expenses, and attorney fees arising out of, directly or indirectly, any claim of personal injury or death associated with such unintended or unauthorized application.

Products described herein may be covered by one or more United States, international or foreign patents pending. Product names and markings noted herein may also be covered by one or more United States, international or foreign trademarks.

**LIFE SUPPORT**

Diodes Incorporated products are specifically not authorized for use as critical components in life support devices or systems without the express written approval of the Chief Executive Officer of Diodes Incorporated. As used herein:

A. Life support devices or systems are devices or systems which:

1. are intended to implant into the body, or
2. support or sustain life and whose failure to perform when properly used in accordance with instructions for use provided in the labeling can be reasonably expected to result in significant injury to the user.

B. A critical component is any component in a life support device or system whose failure to perform can be reasonably expected to cause the failure of the life support device or to affect its safety or effectiveness.

Customers represent that they have all necessary expertise in the safety and regulatory ramifications of their life support devices or systems, and acknowledge and agree that they are solely responsible for all legal, regulatory and safety-related requirements concerning their products and any use of Diodes Incorporated products in such safety-critical, life support devices or systems, notwithstanding any devices- or systems-related information or support that may be provided by Diodes Incorporated. Further, Customers must fully indemnify Diodes Incorporated and its representatives against any damages arising out of the use of Diodes Incorporated products in such safety-critical, life support devices or systems.

Copyright © 2011, Diodes Incorporated

[www.diodes.com](http://www.diodes.com)

# Mouser Electronics

Authorized Distributor

Click to View Pricing, Inventory, Delivery & Lifecycle Information:

[Diodes Incorporated:](#)

[AH5795-FDC-7](#) [AH5795-WU-7](#)