

100V COMPLEMENTARY PAIR ENHANCEMENT MODE MOSFET
Product Summary

Device	$V_{(BR)DSS}$	$R_{DS(ON)}$ (Ω)max	I_D (A)max $T_A = +25^\circ\text{C}$
Q1	100V	0.230 @ $V_{GS} = 10\text{V}$	2.1
		0.300 @ $V_{GS} = 4.5\text{V}$	1.9
Q2	-100V	0.235 @ $V_{GS} = -10\text{V}$	-2.2
		0.320 @ $V_{GS} = -4.5\text{V}$	-1.9

Description

This new generation complementary dual MOSFET features low on-resistance achievable with low gate drive.

Applications

- DC Motor Control
- Backlighting

Features

- 100V Complementary in SOIC package
- Low On-Resistance
- Fast Switching Speed
- Low Voltage ($V_{GS} = 4.5\text{V}$) gate drive
- **Totally Lead-Free & Fully RoHS Compliant (Notes 1 & 2)**
- **Halogen and Antimony Free. "Green" Device (Note 3)**
- **Qualified to AEC-Q101 Standards for High Reliability**

Mechanical Data

- Case: SO-8
- Case Material: Molded Plastic, "Green" Molding Compound. UL Flammability Classification Rating 94V-0
- Moisture Sensitivity: Level 1 per J-STD-020
- Terminals: Finish - Matte Tin annealed over Copper lead frame. Solderable per MIL-STD-202, Method 208 e3
- Weight: 0.074 grams (approximate)



Top View

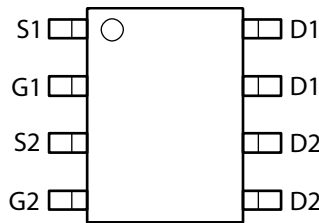

Top View

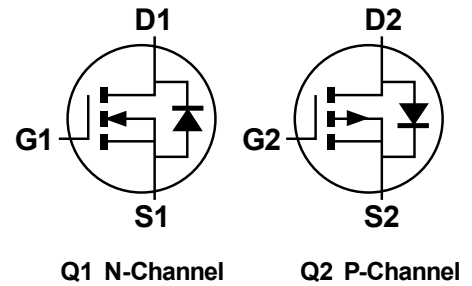

Equivalent Circuit

Ordering Information (Note 4)

Product	Reel size (inches)	Tape width (mm)	Quantity per reel
ZXMC10A816N8	13	12	2,500

- Notes:
1. No purposely added lead. Fully EU Directive 2002/95/EC (RoHS) & 2011/65/EU (RoHS 2) compliant.
 2. See http://www.diodes.com/quality/lead_free.html for more information about Diodes Incorporated's definitions of Halogen- and Antimony-free, "Green" and Lead-free.
 3. Halogen- and Antimony-free "Green" products are defined as those which contain <900ppm bromine, <900ppm chlorine (<1500ppm total Br + Cl) and <1000ppm antimony compounds.
 4. For packaging details, go to our website at <http://www.diodes.com/products/packages.html>.

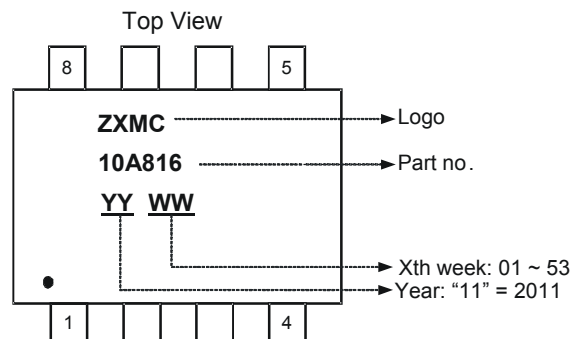
Marking Information

Maximum Ratings (@T_A = +25°C, unless otherwise specified.)

Parameter	Symbol	N-channel Q1	P-channel Q2	Unit
Drain-Source Voltage	V _{DSS}	100	-100	V
Gate-Source Voltage	V _{GS}	±20	±20	V
Continuous Drain Current @ V _{GS} = 10V; T _A = +25°C ^{(b)(d)} @ V _{GS} = 10V; T _A = +70°C ^{(b)(d)} @ V _{GS} = 10V; T _A = +25°C ^{(a)(d)} @ V _{GS} = 10V; T _A = +25°C ^{(a)(e)} @ V _{GS} = 10V; T _L = +25°C ^{(f)(d)}	I _D	2.1 1.7 1.7 2.0 2.3	-2.2 -1.8 -1.7 -2.0 -2.4	A
Pulsed Drain Current @ V _{GS} = 10V; T _A = +25°C ^{(c)(d)}	I _{DM}	9.4	-10.5	A
Continuous Source Current (Body Diode) at T _A = +25°C ^{(b)(d)}	I _S	3.0	-3.1	A
Pulsed Source Current (Body Diode) at T _A = +25°C ^{(c)(d)}	I _{SM}	9.4	-10.5	A
Avalanche Current (g) L = 0.1 mH	I _{AS}	1.2	12	A
Power Dissipation at T _A = +25°C ^{(a)(d)} Linear Derating Factor	P _D	1.3 10.0		W mW/°C
Power Dissipation at T _A = +25°C ^{(a)(e)} Linear Derating Factor	P _D	1.8 14.2		W mW/°C
Power Dissipation at T _A = +25°C ^{(b)(d)} Linear Derating Factor	P _D	2.1 16.7		W mW/°C
Power Dissipation at T _L = +25°C ^{(f)(d)} Linear Derating Factor	P _D	2.4 18.9	2.6 20.4	W mW/°C
Operating and Storage Temperature Range	T _j , T _{stg}	-55 to +150		°C

Thermal Characteristics

Parameter	Symbol	Value	Unit	
Junction to Ambient ^{(a)(d)}	R _{θJA}	100	°C/W	
Junction to Ambient ^{(a)(e)}	R _{θJA}	70	°C/W	
Junction to Ambient ^{(b)(d)}	R _{θJA}	60	°C/W	
Junction to Lead ^{(f)(d)}	R _{θJL}	53	49	°C/W

- Notes:
- (a) For a device surface mounted on 25mm x 25mm x 1.6mm FR4 PCB with high coverage of single sided 1oz copper, in still air conditions; the device is measured when operating in a steady-state condition.
 - (b) Same as note (a), except the device is measured at t ≤ 10 sec.
 - (c) Same as note (a), except the device is pulsed with D= 0.02 and pulse width 300µs. The pulse current is limited by the maximum junction temperature.
 - (d) For a dual device with one active die.
 - (e) For a device with two active die running at equal power.
 - (f) Thermal resistance from junction to solder-point (at the end of the drain lead); the device is operating in a steady-state condition.
 - (g) IAS rating are based on low frequency and duty cycles to keep T_j = +25°C.

Thermal Characteristics

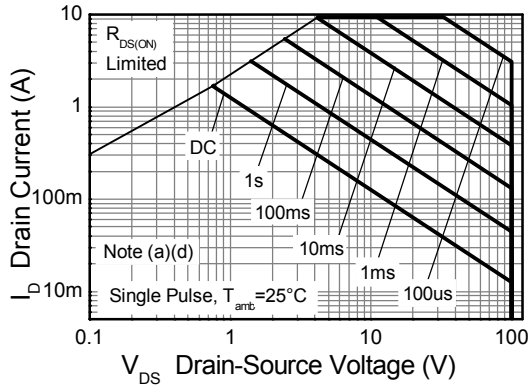

N-channel Safe Operating Area

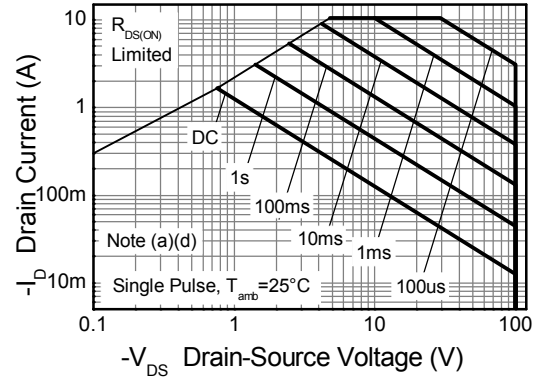

P-channel Safe Operating Area

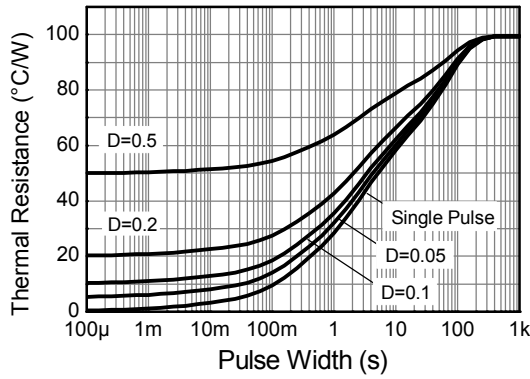

Transient Thermal Impedance

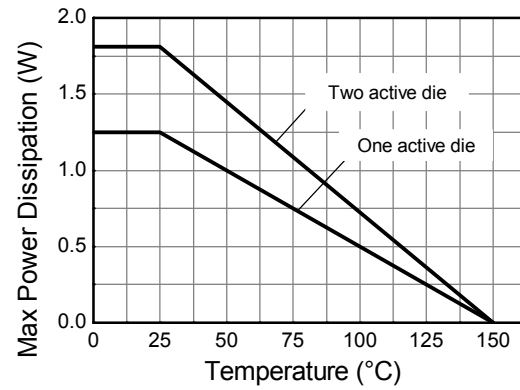

Derating Curve

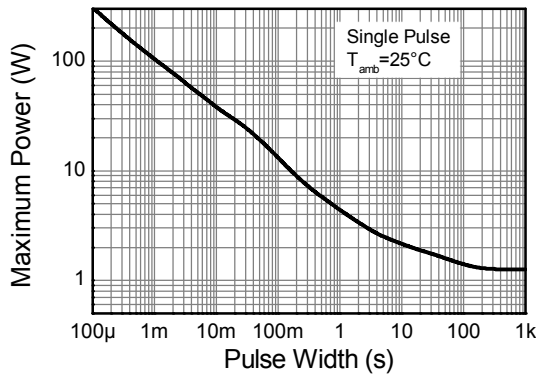

Pulse Power Dissipation

Electrical Characteristics Q1 N-Channel (@T_A = +25°C, unless otherwise specified.)

Parameter	Symbol	Min	Typ	Max	Unit	Conditions
Static						
Drain-Source Breakdown Voltage	V _{(BR)DSS}	100	—	—	V	I _D = 250μA, V _{GS} = 0V
Zero Gate Voltage Drain Current	I _{DSS}	—	—	0.5	μA	V _{DS} = 100V, V _{GS} = 0V
Gate-Body Leakage	I _{GSS}	—	—	100	nA	V _{GS} = ±20V, V _{DS} = 0V
Gate-Source Threshold Voltage	V _{GS(th)}	1.7	—	2.4	V	I _D = 250μA, V _{DS} = V _{GS}
Static Drain-Source On-State Resistance ^(a)	R _{DS(ON)}	—	0.170 0.210	0.230 0.300	Ω	V _{GS} = 10V, I _D = 1.0A V _{GS} = 4.5V, I _D = 0.5A
Forward Transconductance ^{(a) (c)}	g _{fs}	—	4.8	—	S	V _{DS} = 15V, I _D = 1.6A
Dynamic Capacitance ^(c)						
Input Capacitance	C _{iss}	—	497	—	pF	V _{DS} = 50V, V _{GS} = 0V f = 1MHz
Output Capacitance	C _{oss}	—	29	—	pF	
Reverse Transfer Capacitance	C _{rss}	—	18	—	pF	
Switching ^{(b) (c)}						
Turn-On-Delay Time	t _{d(ON)}	—	2.9	—	ns	V _{DD} = 50V, V _{GS} = 10V I _D = 1.0A R _G ≅ 6.0Ω,
Rise Time	t _r	—	2.1	—	ns	
Turn-Off Delay Time	t _{d(OFF)}	—	12.1	—	ns	
Fall Time	t _f	—	5.0	—	ns	
Gate Charge ^(c)						
Total Gate Charge	Q _g	—	9.2	—	nC	V _{DS} = 50V, V _{GS} = 10V I _D = 1.6A
Gate-Source Charge	Q _{gs}	—	1.7	—	nC	
Gate-Drain Charge	Q _{gd}	—	2.5	—	nC	
Source-Drain Diode						
Diode Forward Voltage ^(a)	V _{SD}	—	0.85	0.95	V	I _S = 1.7A, V _{GS} = 0V
Reverse Recovery Time ^(c)	t _{rr}	—	32	—	ns	I _S = 1.7A, di/dt = 100A/μs
Reverse Recovery Charge ^(c)	Q _{rr}	—	40	—	nC	
Gate Resistance						
Gate Resistance	R _G	0	—	3	Ω	V _{DS} = 0V, V _{GS} = 0V, f = 1.0MHz

Notes: (a) Measured under pulsed conditions. Pulse width ≤ 300μs; duty cycle ≤ 2%.
(b) Switching characteristics are independent of operating junction temperature.
(c) For design aid only, not subject to production testing.

Typical Characteristics Q1 N-Channel

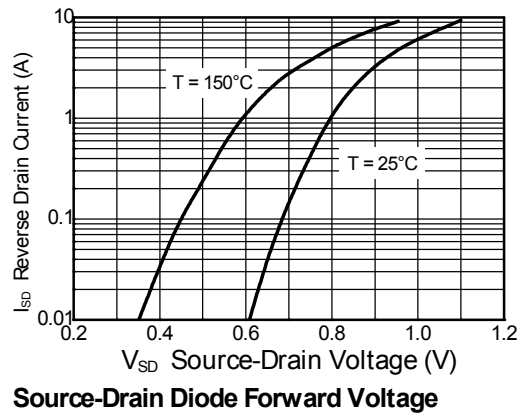
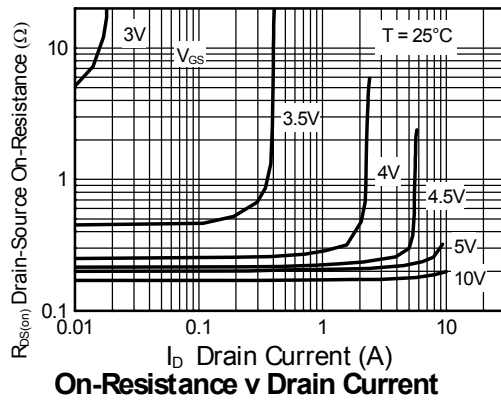
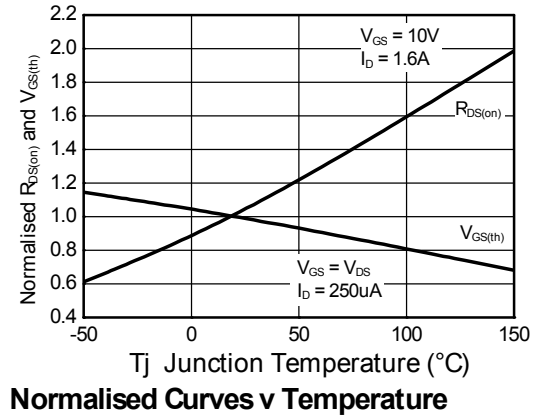
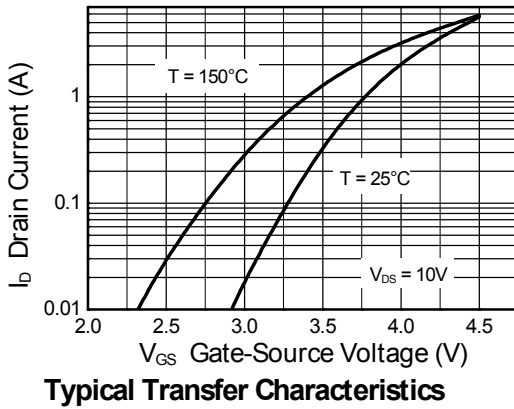
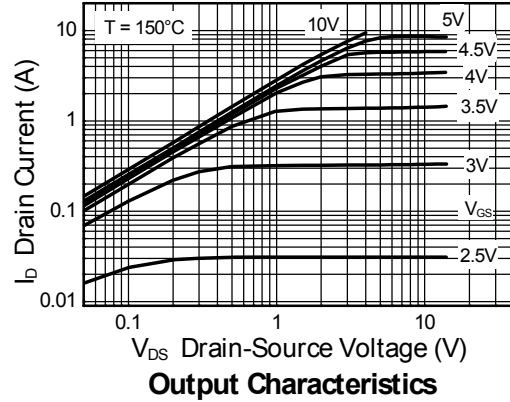
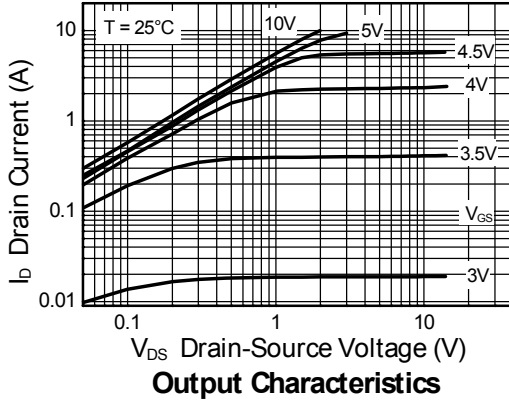

Typical Characteristics Q1 N-Channel (cont.)

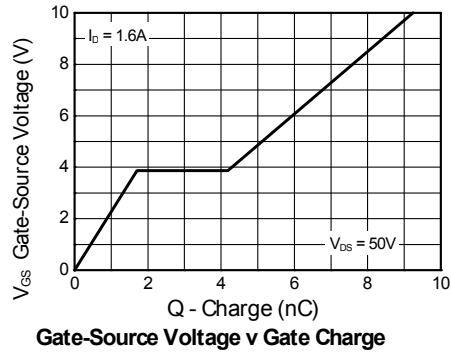
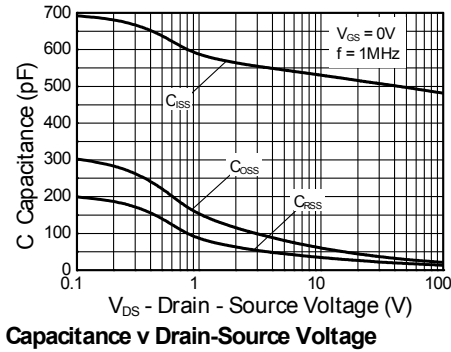

Test Circuits

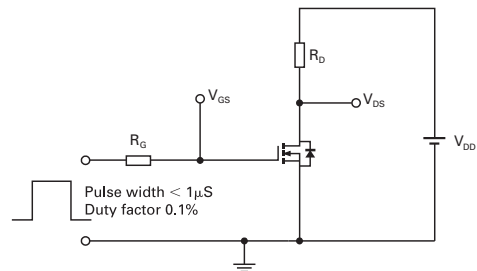
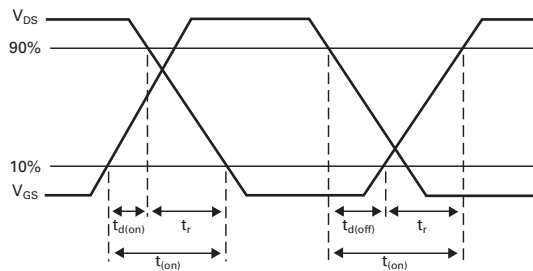
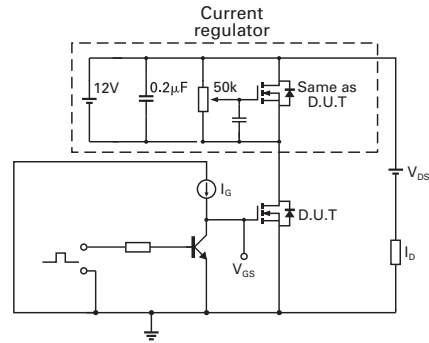
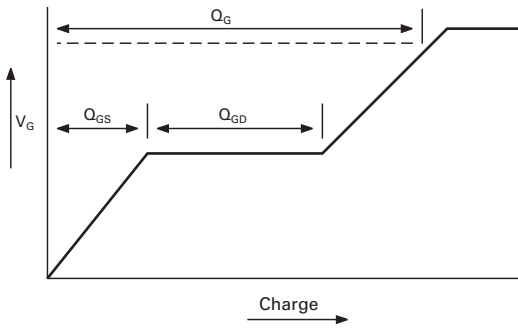

Electrical Characteristics Q2 P-Channel (@T_A = +25°C, unless otherwise specified.)

Parameter	Symbol	Min	Typ	Max	Unit	Conditions
Static						
Drain-Source Breakdown Voltage	V _{(BR)DSS}	-100	—	—	V	I _D = -250μA, V _{GS} = 0V
Zero Gate Voltage Drain current	I _{DSS}	—	—	-0.5	μA	V _{DS} = -100V, V _{GS} = 0V
Gate-Body Leakage	I _{GSS}	—	—	100	nA	V _{GS} = ±20V, V _{DS} = 0V
Gate-Source Threshold Voltage	V _{GS(th)}	-2.0	—	-3.0	V	I _D = -250μA, V _{DS} = V _{GS}
Static Drain-Source On-State Resistance ^(a)	R _{DS(ON)}	—	0.170 0.250	0.235 0.320	Ω	V _{GS} = -10V, I _D = -1.0A V _{GS} = -4.5V, I _D = -0.5A
Forward Transconductance ^{(a)(c)}	g _{fs}	—	4.7	—	S	V _{DS} = -15V, I _D = -2.1A
Dynamic Capacitance ^(c)						
Input Capacitance	C _{iss}	—	717	—	pF	V _{DS} = -50V, V _{GS} = 0V f = 1MHz
Output Capacitance	C _{oss}	—	55	—	pF	
Reverse Transfer Capacitance	C _{rss}	—	46	—	pF	
Switching ^{(b)(c)}						
Turn-On-Delay Time	t _{d(ON)}	—	4.3	—	ns	V _{DD} = -50V, V _{GS} = -10V I _D = -1A R _G ≅ 6.0Ω,
Rise Time	t _r	—	5.2	—	ns	
Turn-Off Delay Time	t _{d(OFF)}	—	20	—	ns	
Fall Time	t _f	—	12	—	ns	
Gate Charge ^(c)						
Total Gate Charge	Q _g	—	16.5	—	nC	V _{DS} = -50V, V _{GS} = -10V I _D = -2.1A
Gate-Source Charge	Q _{gs}	—	2.5	—	nC	
Gate-Drain Charge	Q _{gd}	—	5.4	—	nC	
Source-Drain Diode						
Diode Forward Voltage ^(a)	V _{SD}	—	-0.85	-0.95	V	I _S = -1.7A, V _{GS} = 0V
Reverse Recovery Time ^(c)	t _{rr}	—	43	—	ns	I _S = -1.7A, di/dt = 100A/μs
Reverse Recovery Charge ^(c)	Q _{rr}	—	77	—	nC	
Gate Resistance						
Gate Resistance	R _G	0	—	100	Ω	V _{DS} = 0V, V _{GS} = 0V, f = 1.0MHz

- Notes: (a) Measured under pulsed conditions. Pulse width ≤ 300μs; duty cycle ≤ 2%.
 (b) Switching characteristics are independent of operating junction temperature.
 (c) For design aid only, not subject to production testing.

Typical Characteristics Q2 P-Channel

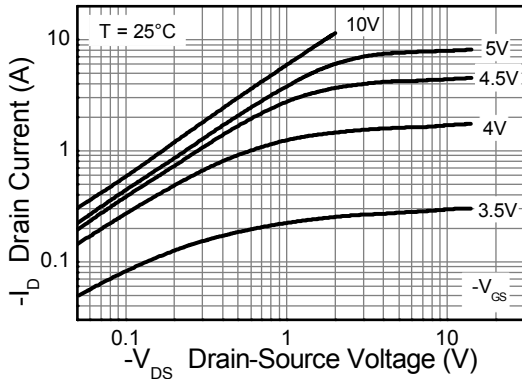

Output Characteristics

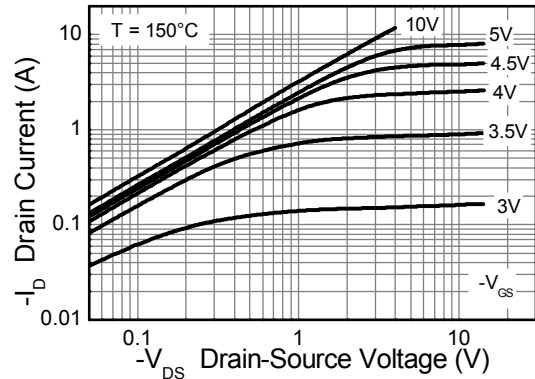

Output Characteristics

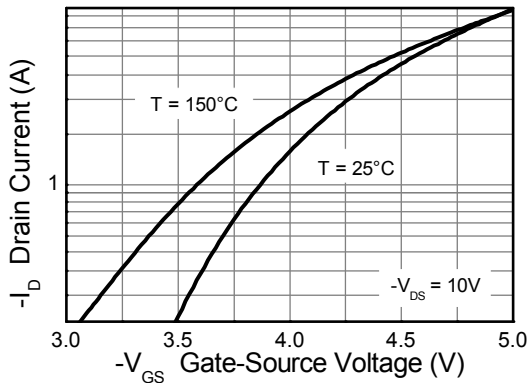

Typical Transfer Characteristics

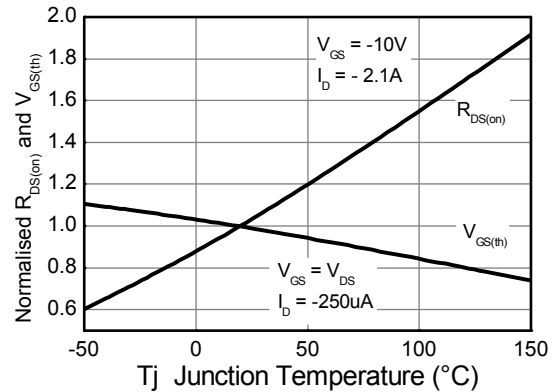

Normalised Curves v Temperature

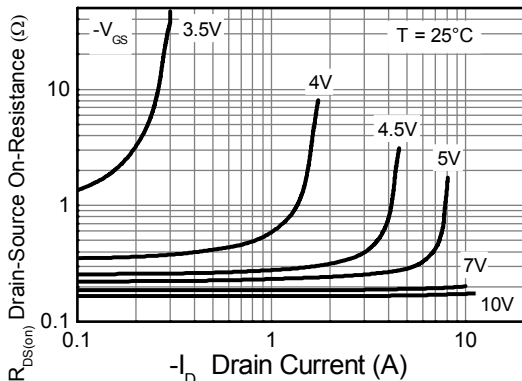

On-Resistance v Drain Current

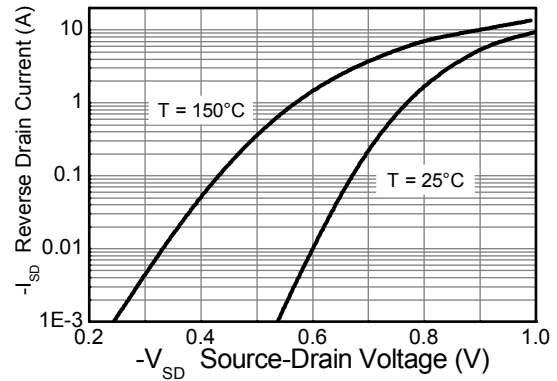

Source-Drain Diode Forward Voltage

Typical Characteristics Q2 P-Channel (cont.)

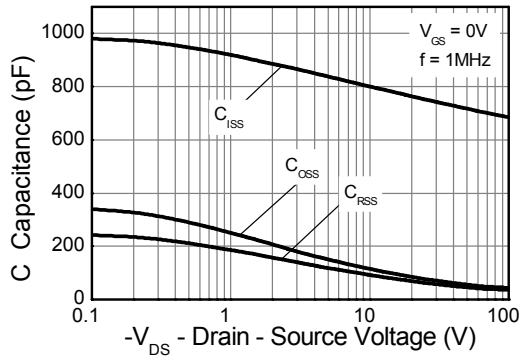

Capacitance v Drain-Source Voltage

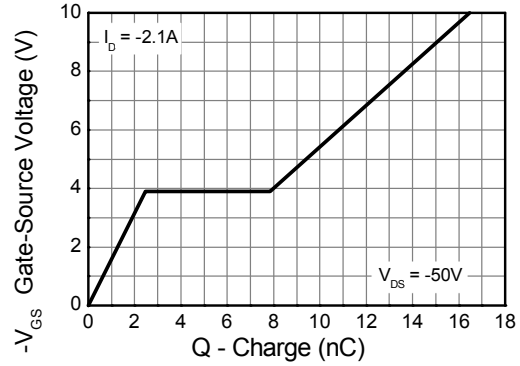

Gate-Source Voltage v Gate Charge

Test Circuits

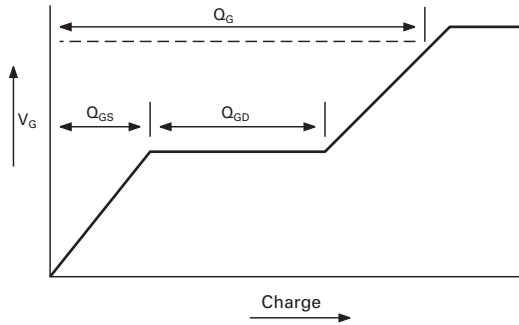

Basic gate charge waveform

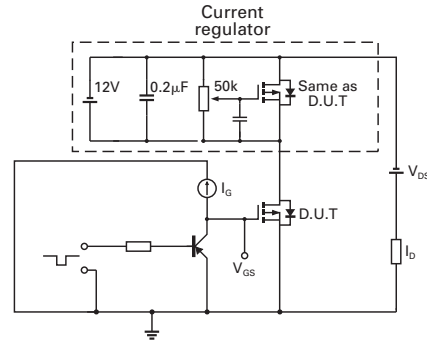

Gate charge test circuit

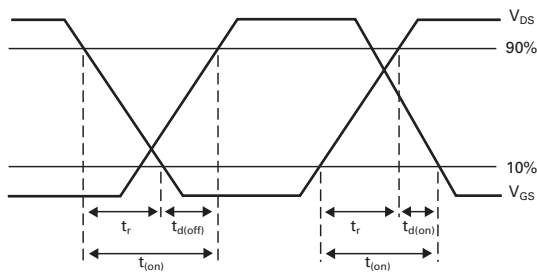

Switching time waveforms

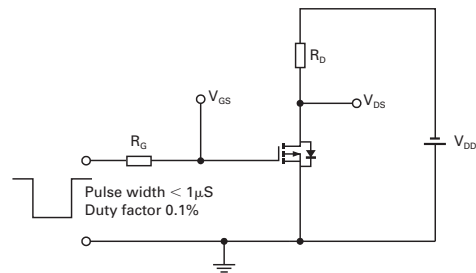

Switching time test circuit

Package Outline Dimensions

Please see AP02002 at <http://www.diodes.com/datasheets/ap02002.pdf> for latest version.

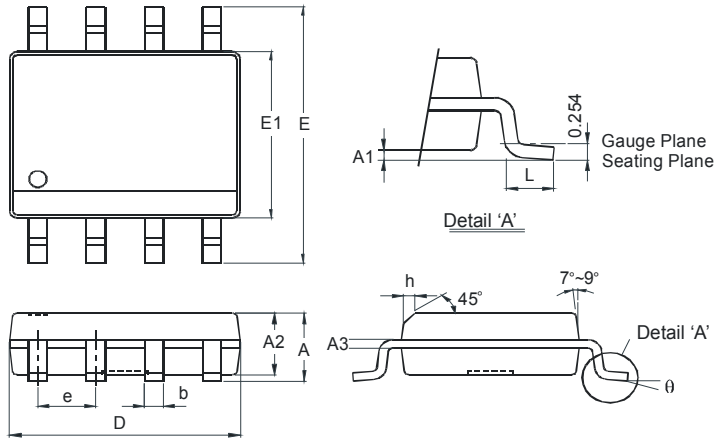

SO-8		
Dim	Min	Max
A	-	1.75
A1	0.10	0.20
A2	1.30	1.50
A3	0.15	0.25
b	0.3	0.5
D	4.85	4.95
E	5.90	6.10
E1	3.85	3.95
e	1.27 Typ	
h	-	0.35
L	0.62	0.82
θ	0°	8°
All Dimensions in mm		

Suggested Pad Layout

Please see AP02001 at <http://www.diodes.com/datasheets/ap02001.pdf> for the latest version.

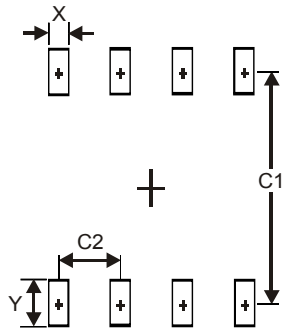

Dimensions	Value (in mm)
X	0.60
Y	1.55
C1	5.4
C2	1.27

IMPORTANT NOTICE

DIODES INCORPORATED MAKES NO WARRANTY OF ANY KIND, EXPRESS OR IMPLIED, WITH REGARDS TO THIS DOCUMENT, INCLUDING, BUT NOT LIMITED TO, THE IMPLIED WARRANTIES OF MERCHANTABILITY AND FITNESS FOR A PARTICULAR PURPOSE (AND THEIR EQUIVALENTS UNDER THE LAWS OF ANY JURISDICTION).

Diodes Incorporated and its subsidiaries reserve the right to make modifications, enhancements, improvements, corrections or other changes without further notice to this document and any product described herein. Diodes Incorporated does not assume any liability arising out of the application or use of this document or any product described herein; neither does Diodes Incorporated convey any license under its patent or trademark rights, nor the rights of others. Any Customer or user of this document or products described herein in such applications shall assume all risks of such use and will agree to hold Diodes Incorporated and all the companies whose products are represented on Diodes Incorporated website, harmless against all damages.

Diodes Incorporated does not warrant or accept any liability whatsoever in respect of any products purchased through unauthorized sales channel. Should Customers purchase or use Diodes Incorporated products for any unintended or unauthorized application, Customers shall indemnify and hold Diodes Incorporated and its representatives harmless against all claims, damages, expenses, and attorney fees arising out of, directly or indirectly, any claim of personal injury or death associated with such unintended or unauthorized application.

Products described herein may be covered by one or more United States, international or foreign patents pending. Product names and markings noted herein may also be covered by one or more United States, international or foreign trademarks.

This document is written in English but may be translated into multiple languages for reference. Only the English version of this document is the final and determinative format released by Diodes Incorporated.

LIFE SUPPORT

Diodes Incorporated products are specifically not authorized for use as critical components in life support devices or systems without the express written approval of the Chief Executive Officer of Diodes Incorporated. As used herein:

A. Life support devices or systems are devices or systems which:

1. are intended to implant into the body, or
2. support or sustain life and whose failure to perform when properly used in accordance with instructions for use provided in the labeling can be reasonably expected to result in significant injury to the user.

B. A critical component is any component in a life support device or system whose failure to perform can be reasonably expected to cause the failure of the life support device or to affect its safety or effectiveness.

Customers represent that they have all necessary expertise in the safety and regulatory ramifications of their life support devices or systems, and acknowledge and agree that they are solely responsible for all legal, regulatory and safety-related requirements concerning their products and any use of Diodes Incorporated products in such safety-critical, life support devices or systems, notwithstanding any devices- or systems-related information or support that may be provided by Diodes Incorporated. Further, Customers must fully indemnify Diodes Incorporated and its representatives against any damages arising out of the use of Diodes Incorporated products in such safety-critical, life support devices or systems.

Copyright © 2013, Diodes Incorporated

www.diodes.com

Mouser Electronics

Authorized Distributor

Click to View Pricing, Inventory, Delivery & Lifecycle Information:

[Diodes Incorporated:](#)

[ZXMC10A816N8TC](#)