



Is Now Part of



ON Semiconductor®

To learn more about ON Semiconductor, please visit our website at
www.onsemi.com

ON Semiconductor and the ON Semiconductor logo are trademarks of Semiconductor Components Industries, LLC dba ON Semiconductor or its subsidiaries in the United States and/or other countries. ON Semiconductor owns the rights to a number of patents, trademarks, copyrights, trade secrets, and other intellectual property. A listing of ON Semiconductor's product/patent coverage may be accessed at www.onsemi.com/site/pdf/Patent-Marking.pdf. ON Semiconductor reserves the right to make changes without further notice to any products herein. ON Semiconductor makes no warranty, representation or guarantee regarding the suitability of its products for any particular purpose, nor does ON Semiconductor assume any liability arising out of the application or use of any product or circuit, and specifically disclaims any and all liability, including without limitation special, consequential or incidental damages. Buyer is responsible for its products and applications using ON Semiconductor products, including compliance with all laws, regulations and safety requirements or standards, regardless of any support or applications information provided by ON Semiconductor. "Typical" parameters which may be provided in ON Semiconductor data sheets and/or specifications can and do vary in different applications and actual performance may vary over time. All operating parameters, including "Typicals" must be validated for each customer application by customer's technical experts. ON Semiconductor does not convey any license under its patent rights nor the rights of others. ON Semiconductor products are not designed, intended, or authorized for use as a critical component in life support systems or any FDA Class 3 medical devices or medical devices with a same or similar classification in a foreign jurisdiction or any devices intended for implantation in the human body. Should Buyer purchase or use ON Semiconductor products for any such unintended or unauthorized application, Buyer shall indemnify and hold ON Semiconductor and its officers, employees, subsidiaries, affiliates, and distributors harmless against all claims, costs, damages, and expenses, and reasonable attorney fees arising out of, directly or indirectly, any claim of personal injury or death associated with such unintended or unauthorized use, even if such claim alleges that ON Semiconductor was negligent regarding the design or manufacture of the part. ON Semiconductor is an Equal Opportunity/Affirmative Action Employer. This literature is subject to all applicable copyright laws and is not for resale in any manner.

FAN5701 — Compact 6-LED Driver for Mobile Platforms

Features

- Six (6) Parallel LEDs (up to 30mA each)
- Total Package Load Current Capability: 180mA
- Two Default Groups of Four (4) and Two (2) LEDs for Main and Sub-Display Lighting with Individual PWM Dimming Controls that Operate up to 20kHz
- >600:1 Dimming Ratio for 100Hz PWM Frequency
- Up to 92% Efficiency
- Built-in 1.5x Charge Pump with Low-Dropout Bypass Switch
- Wide Input Range: 2.7V to 5.5V
- V_{OUT} Over-Voltage and Short-Circuit Protection
- Over-Temperature Protection
- 1.2MHz Switching Frequency for Small-Sized Capacitors
- 16-Bump 1.61mm x 1.61mm WLCSP (0.6mm Height)
- 16-Lead 3.0mm x 3.0mm UMLP (0.55mm Height)

Applications

- LCD Backlighting
- Keypad Backlighting
- Mobile Handsets
- Portable Media Player

Description

The FAN5701 is a highly integrated and efficient charge-pump-based multi-LED driver. The device can drive up to six LEDs in parallel with a total output current of 180mA.

The FAN5701 is capable of driving a primary display backlight requiring four to six LEDs. When more than four LEDs are needed for backlighting, the FAN5701's two PWM dimming inputs can be connected together to provide the proper dimming control for all six LEDs. When a primary and sub-display is needed, the FAN5701 can be controlled such that each group can be dimmed independently. For candy-bar phones requiring a primary display and keypad lighting, the FAN5701 offers a simple, and compact lighting solution.

Regulated internal current sinks deliver excellent current and brightness matching to all six LEDs. The device provides excellent efficiency without an inductor by operating the charge pump in 1.5x or pass-through modes.

The FAN5701 can be ordered with I_{SET} values of 30mA, 20mA, 15mA, or 8mA and available in WLCSP or ultra-thin UMLP package types. The default I_{SET} is always determined by the part number purchased (see *Ordering Information*)

Ordering Information

Part Number	LED Current (I _{SET})	Temperature Range	Package	Packing
FAN5701UC30X	30mA	-40°C to 85°C	WLCSP-16, 0.4mm Pitch	Tape and Reel
FAN5701UC20X	20mA	-40°C to 85°C	WLCSP-16, 0.4mm Pitch	Tape and Reel
FAN5701UC15X	15mA	-40°C to 85°C	WLCSP-16, 0.4mm Pitch	Tape and Reel
FAN5701UC08X	8mA	-40°C to 85°C	WLCSP-16, 0.4mm Pitch	Tape and Reel
FAN5701UMP30X	30mA	-40°C to 85°C	UMLP-16, 3.0 x 3.0 x 0.55mm	Tape and Reel
FAN5701UMP20X	20mA	-40°C to 85°C	UMLP-16, 3.0 x 3.0 x 0.55mm	Tape and Reel
FAN5701UMP15X	15mA	-40°C to 85°C	UMLP-16, 3.0 x 3.0 x 0.55mm	Tape and Reel
FAN5701UMP08X	8mA	-40°C to 85°C	UMLP-16, 3.0 x 3.0 x 0.55mm	Tape and Reel

Block Diagram

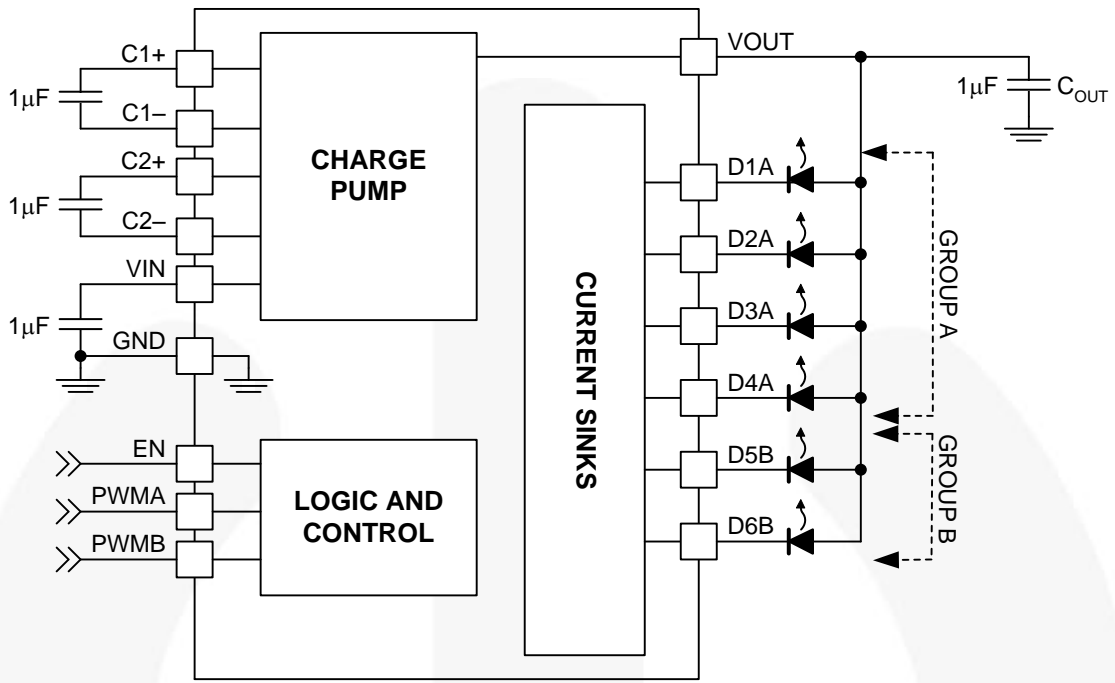

Figure 1. Typical Application

WLCSP Pin Configuration

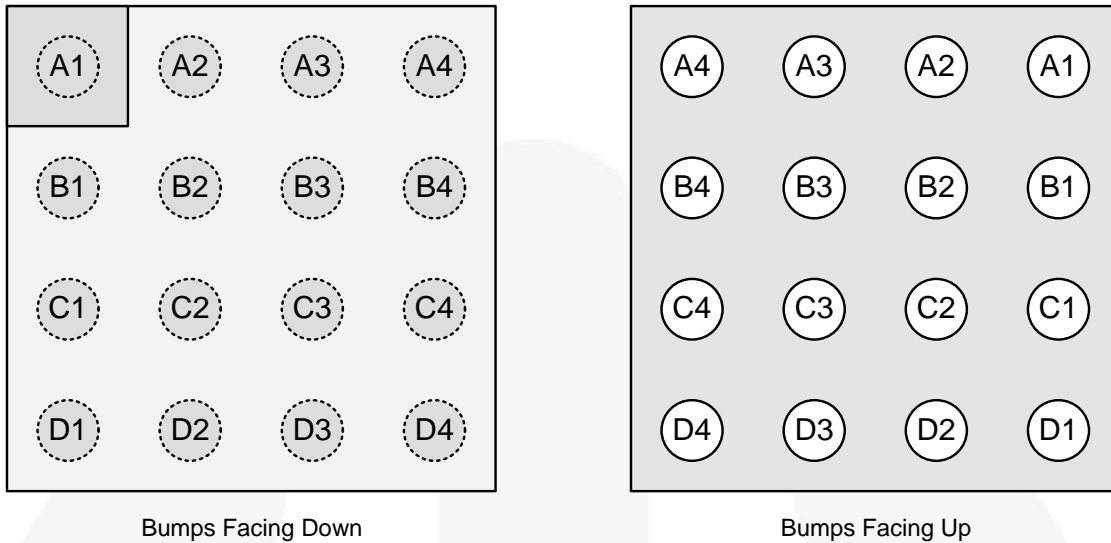

Figure 2. WLCSP-16, 0.4mm Pitch, 1.61mm x 1.61mm

Pin Definitions

Pin #	Name	Description
D2	VIN	Input Voltage. Connect to 2.7 – 5.5V _{DC} input power source.
B4	GND	Ground
D1	VOUT	Charge Pump Output Voltage. Connect to LED Anodes.
D3,D4	C1+, C1–	C1. Charge pump flying capacitor #1.
C3,C4	C2+, C2–	C2. Charge pump flying capacitor #2.
A1, A2, B1, B2, C1, C2	D2A, D1A, D4A, D3A, D6B, D5B	LED Outputs
A4	EN	Enable. When this pin is HIGH, normal operation is enabled. When LOW, the IC is reset and all functions are disabled.
B3	PWMA	Group-A PWM Dimming Input
A3	PWMB	Group-B PWM Dimming Input

UMLP Pin Configuration

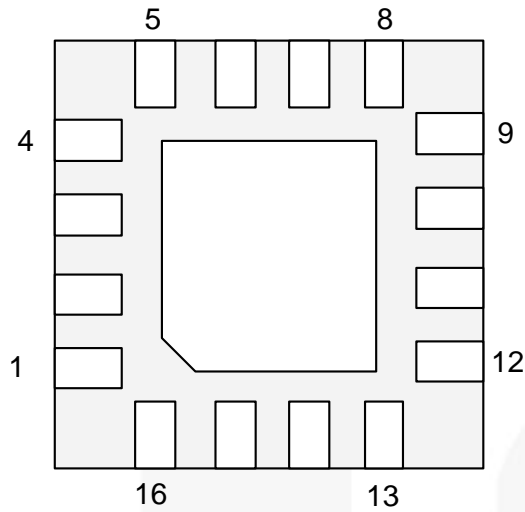

Figure 3. UMLP-16, 0.5mm Pitch, 3mm x 3mm (Bottom View)

Pin Definitions

Pin #	Name	Description
11	VIN	Input Voltage. Connect to 2.7 – 5.5V _{DC} input power source.
6	GND	Ground
12	VOUT	Charge Pump Output Voltage. Connect to LED Anodes.
10,9	C1+, C1–	C1. Charge pump flying capacitor #1.
8,7	C2+, C2–	C2. Charge pump flying capacitor #2.
1,2, 15, 16, 13, 14	D2A, D1A, D4A, D3A, D6B, D5B	LED Inputs
4	EN	Enable. When this pin is HIGH, normal operation is enabled. When LOW, the IC is reset and all functions are disabled.
5	PWMA	Group-A PWM Dimming Input
3	PWMB	Group-B PWM Dimming Input

Absolute Maximum Ratings

Stresses exceeding the absolute maximum ratings may damage the device. The device may not function or be operable above the recommended operating conditions and stressing the parts to these levels is not recommended. In addition, extended exposure to stresses above the recommended operating conditions may affect device reliability. The absolute maximum ratings are stress ratings only.

Symbol	Parameter		Min.	Max.	Units
V _{CC}	VIN, VOUT Pins		-0.3	6.0	V
	Other Pins ⁽¹⁾		-0.3	AV _{IN} + 0.3	V
ESD	Electrostatic Discharge Protection Level	Human Body Model, JESD22-A114	3		kV
		Charged Device Model, JESD22-C101	UMLP16	2	
		Charged Device Model, JESD22-C101	WLCSP-16	1	
T _J	Junction Temperature		-40	+150	°C
T _{STG}	Storage Temperature		-65	+150	°C
T _L	Lead Soldering Temperature, 10 Seconds			+260	°C

Note:

1. Lesser of V_{IN} + 0.3 or 6.0V.

Recommended Operating Conditions

The Recommended Operating Conditions table defines the conditions for actual device operation. Recommended operating conditions are specified to ensure optimal performance to the datasheet specifications. Fairchild does not recommend exceeding them or designing to absolute maximum ratings.

Symbol	Parameter	Min.	Max.	Units
V _{IN}	Supply Voltage	2.7	5.5	V
V _{LED}	LED Forward Voltage	2	4	V
T _A	Ambient Temperature	-40	+85	°C
T _J	Junction Temperature	-40	+125	°C

Thermal Properties

Symbol	Parameter		Min.	Typ.	Max.	Units
Θ _{JA}	Junction-to-Ambient Thermal Resistance ⁽²⁾	WLCSP		80		°C/W
		UMLP		49		°C/W

Note:

2. Junction-to-ambient thermal resistance is a function of application and board layout. This data is measured with four-layer 2s2p boards in accordance to JESD51- JEDEC standard. Special attention must be paid not to exceed junction temperature T_{J(max)} at a given ambient temperature T_A.

Electrical Specifications

Unless otherwise specified; $V_{IN} = 2.7V$ to $5.5V$, $T_A = -40^{\circ}C$ to $+85^{\circ}C$, and $EN = V_{IN}$. Typical values are $V_{IN} = 3.6V$, $T_A = 25^{\circ}C$, $I_{LED} = 20mA$, and LED cathode terminals = $0.4V$. Circuit and components are according to Figure 1.

Symbol	Parameter	Conditions	Min.	Typ.	Max.	Units
Power Supplies and Thermal Protection						
I_Q	Quiescent Supply Current	1.5x Mode, No LEDs		4.4		mA
		1x Mode, No LEDs		0.7		mA
I_{SD}	Shutdown Supply Current	$EN = 0$, $V_{IN} = 4.5V$, $T_A = -40^{\circ}C$ to $+85^{\circ}C$		1.5	4.0	μA
V_{UVLO}	Under-Voltage Lockout Threshold	V_{IN} Rising		2.55	2.70	V
		V_{IN} Falling	2.20	2.40		
V_{UVHYST}	Under-Voltage Lockout Hysteresis			150		mV
OVP	Over-Voltage Protection			6		V
T_{LIMIT}	Thermal Shutdown			150		$^{\circ}C$
T_{HYST}	Thermal Shutdown Hysteresis			20		$^{\circ}C$
LED Current Sinks						
I_{LED}	Absolute Current Accuracy	$V_{CATHODE} = 0.4V$, See Options for I_{SET}	-10%	I_{SET}	+10%	mA
$I_{LED(MAX)}$	Maximum Diode Current ⁽³⁾	$I_{LED} = I_{SET}$		30		mA
I_{LED_MATCH}	LED Current Matching ⁽⁴⁾	$V_{CATHODE} = 0.4V$, $I_{LED} = I_{SET}$		0.4	3.0	%
V_{DTH}	1x to 1.5x Gain Transition Threshold	LED Cathode Voltage Falling		100		mV
V_{HR}	Current Sink Headroom ⁽⁵⁾	$I_{LED} = 90\% I_{LED(NOMINAL)}$		65		mV
Charge Pump						
R_{OUT}	Output Resistance	1.5x Mode		2.4		Ω
		1x Mode		0.9		Ω
f_{SW}	Switching Frequency		0.9	1.2	1.5	MHz
t_{START}	Startup Time	$V_{OUT} = 90\%$ of Steady State		250		μs
PWM Dimming						
f_{PWM}	PWM Dimming Frequency	$t_{ON_LED} = 15\mu s$ (Minimum)			20	kHz
D_{PWM}	PWM Duty-Cycle	$f_{PWM} = 100Hz$	0.15		100.00	%
Logic Inputs (EN, PWMA, PWMB)						
V_{IH}	HIGH-Level Input Voltage		1.2			V
V_{IL}	LOW-Level Input Voltage				0.4	V
V_{IMAX}	Maximum Input Voltage			1.8	5.5	V
I_{IN}	Input Bias Current	Input Tied to GND or V_{IN}		0.01	1.00	μA

Notes:

- The maximum total output current for the IC should be limited to 180mA. The total output current can be split between the two groups ($IDxA = IDxB = 30mA$ maximum). Under maximum output current conditions, special attention must be given to input voltage and LED forward voltage to ensure proper current regulation. See the *Maximum Output Current* section of the datasheet for more information.
- For the two groups of current sinks on a part (GroupA and GroupB), the following are determined: the maximum sink current in the group (MAX), the minimum sink current in the group (MIN), and the average sink current of the group (AVG). For each group, two matching numbers are calculated: $(MAX-AVG)/AVG$ and $(AVG-MIN)/AVG$. The largest number of the two (worst case) is considered the matching figure for the group. The matching figure for a given part is considered to be the highest matching figure of the two groups. The typical specification provided is the most likely norm of the matching figure for all parts.
- For each Dxx pin, headroom voltage is the voltage across the internal current sink connected to that pin. $V_{HRx} = V_{OUT} - V_{LED}$. If headroom voltage requirement is not met, LED current regulation is compromised.

Typical Characteristics

$V_{IN} = 3.6V$, $T_A = 25^\circ C$, $I_{LED} = 20mA$, and LED cathode terminals = 0.4V.

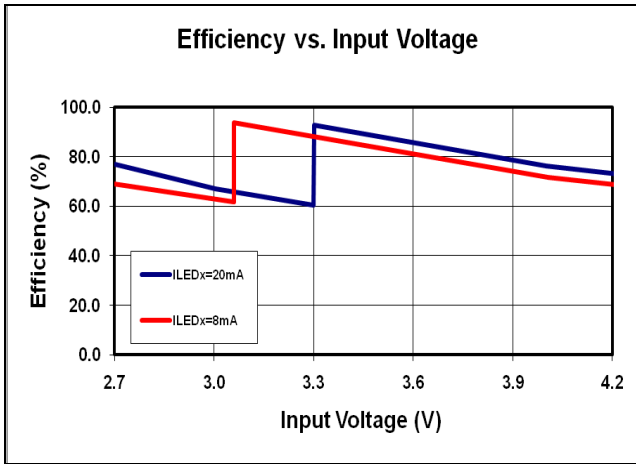

Figure 4. Efficiency with LED Current of 8mA and 20mA

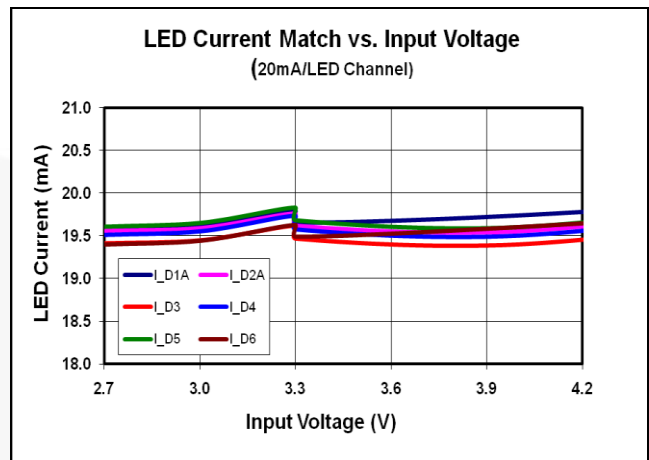

Figure 5. LED Current Match for all Six LED Channels at $I_{LED}=20mA$

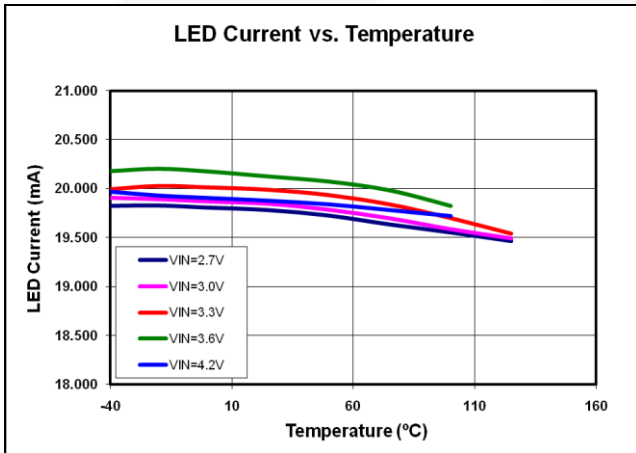

Figure 6. LED Current Variation vs. Temperature

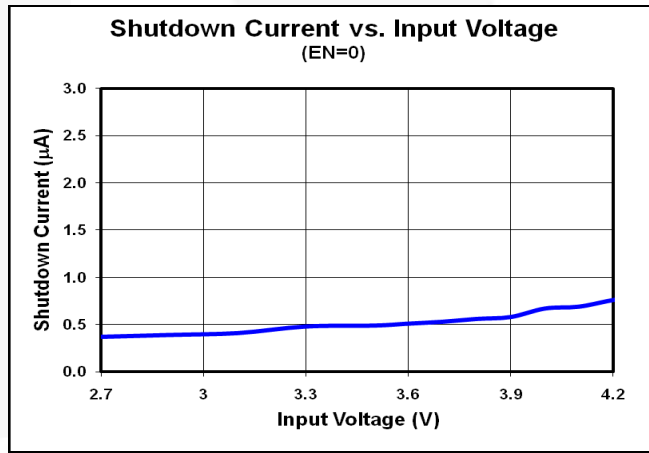

Figure 7. Shutdown Current vs. Input Voltage

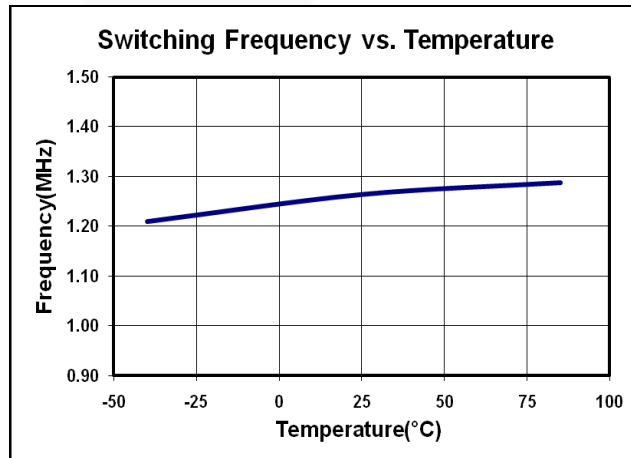

Figure 8. Switching Frequency vs. Temperature with LED Current of 20mA

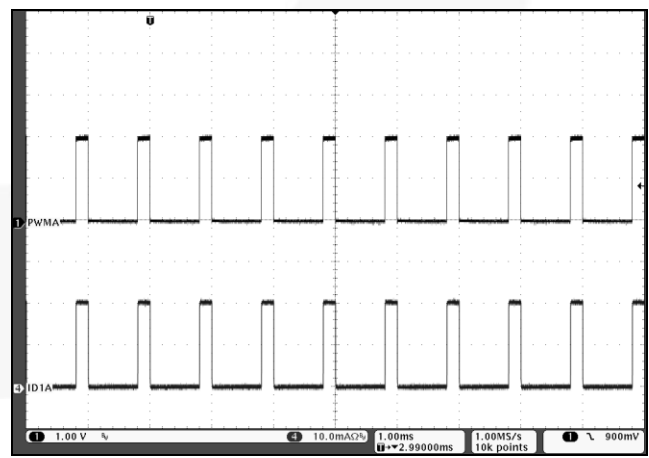

Figure 9. PWM Dimming $V_{IN}=3.6V$, $I_{LEDx}=20mA$, $EN=1kHz$ with 20% Duty Cycle

Typical Characteristics (Continued)

$V_{IN} = 3.6V$, $T_A = 25^\circ C$, $I_{LED} = 20mA$, and LED cathode terminals = $0.4V$.

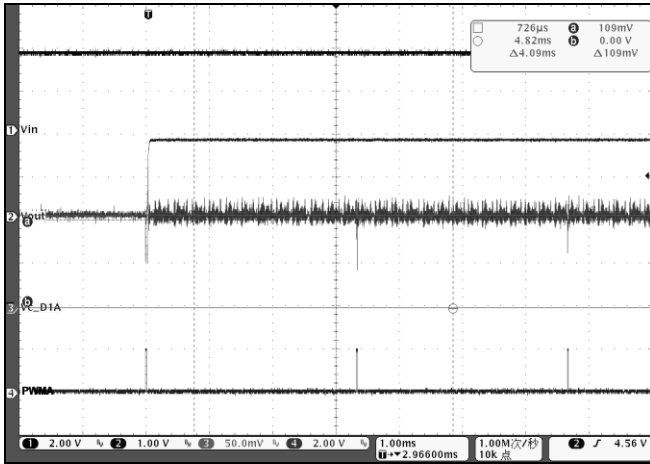

Figure 10. Mode Transition from 1x to 1.5x Mode, $V_{IN}=3.6V$ ($V_{CATHODE}$ Ramp Up)

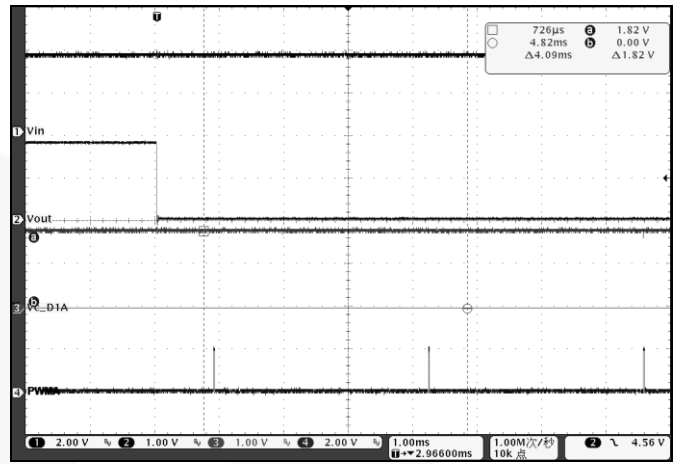

Figure 11. Mode Transition from 1.5x to 1x Mode, $V_{IN}=3.6V$ ($V_{CATHODE}$ Ramp Down)

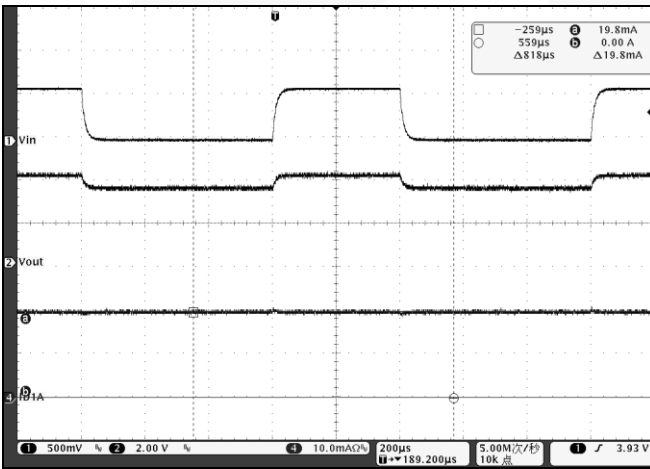

Figure 12. Line Transient Response in 1x Mode, $V_{IN}=3.6V - 4.2V$, $I_{LEDx}=20mA$

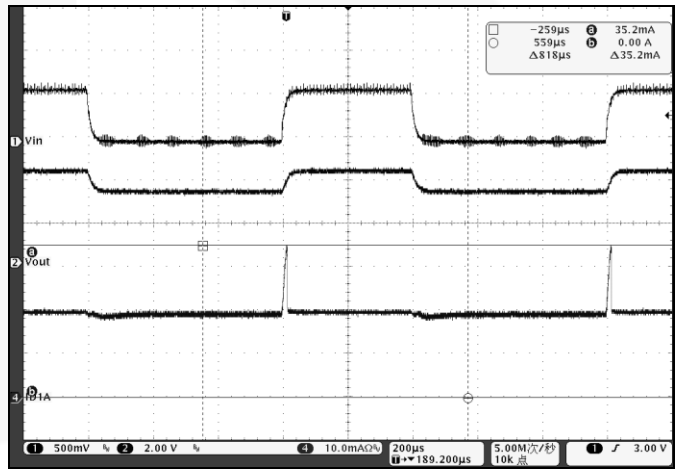

Figure 13. Line Transient Response in 1.5x Mode, $V_{IN}=2.7V - 3.3V$, $I_{LED}=20mA$

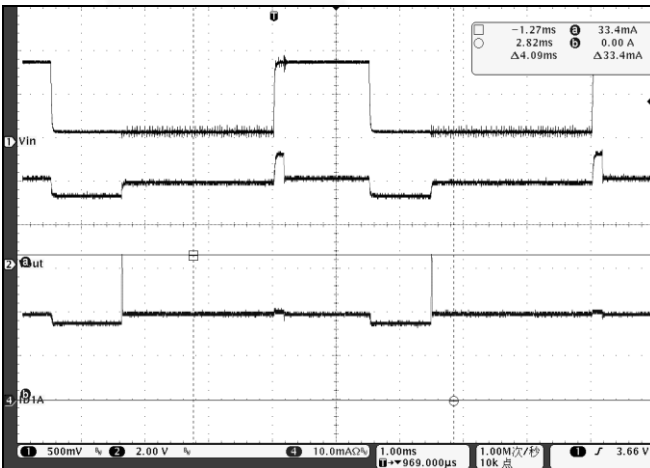

Figure 14. Line Transient from 1x to 1.5x Mode, $V_{IN}=3.2V - 4.1V$, $I_{LEDx}=20mA$

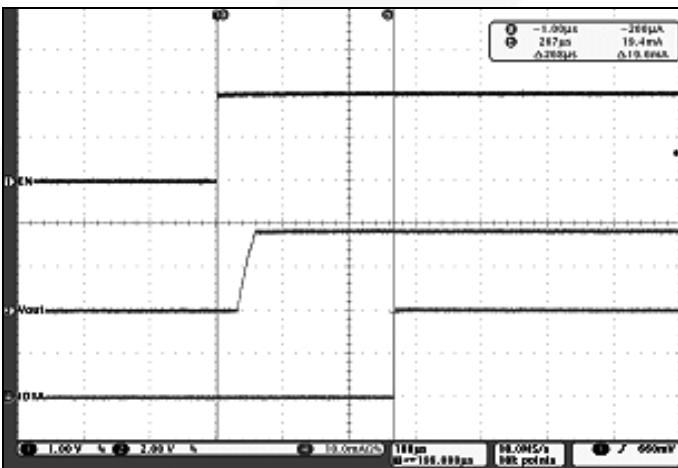

Figure 15. Soft-Start with EN, $V_{IN}=3.6V$, $I_{LEDx}=20mA$

Circuit Description

The FAN5701 is a white LED driver system based upon an adaptive 1.5x/1x charge pump capable of supplying up to 180mA of total output current. The tightly matched current sinks ensure uniform brightness across the LEDs. Each LED is configured in a common anode configuration with its peak drive current set during manufacturing (see *Ordering Information and I_{SET}*).

Charge Pump

The charge pump operates in either 1x mode, where V_{OUT} is connected to V_{IN} through a bypass switch, or in 1.5x mode. The circuit operates in 1x mode until the LED with the highest forward voltage ($V_{LED(MAX)}$) can no longer maintain current regulation. At that point, 1.5x mode begins. If the lowest active cathode voltage is greater than 1.8V, the charge pump switches back to 1x mode.

In addition to hysteresis, a 1ms transition delay is provided for the device to ignore short-duration input voltage drops in deciding mode transitions.

IC Enable

When the EN pin is LOW, all circuit functions are disabled. When the EN pin HIGH, the entire chip is enabled. Both PWM inputs are now functional.

PWM Dimming

External PWM inputs (group A and group B) directly modulate output currents in their corresponding LED channels to vary the perceived LED brightness. Two PWM inputs are provided to control two independent groups of LEDs, such as that of a main display panel and a secondary panel. They can also be connected to a single input to simultaneously dim all six LED outputs.

V_{OUT} Short-Circuit Protection

The FAN5701 has integrated protection circuitry to prevent the device from being short circuited when the output voltage falls below 2V. If this occurs FAN5701 turns off the charge pump and the LED driver outputs, but a small bypass switch is left on. The device monitors the output voltage to determine if it is still in short circuit condition and, once it has passed, FAN5701 soft-starts and returns to normal operation.

V_{OUT} Over-Voltage Protection

If the output voltage goes above 6V, the FAN5701 shuts down until this condition has passed. The charge pump and LED driver outputs are turned off. Once this condition has passed, FAN5701 soft-starts into normal operation.

Physical Dimensions

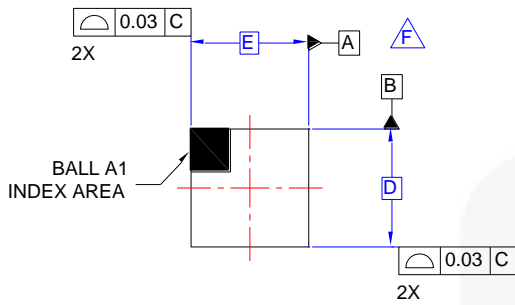

TOP VIEW

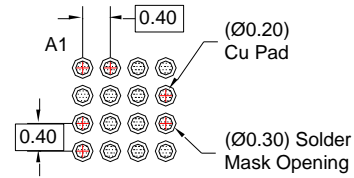

RECOMMENDED LAND PATTERN
(NSMD PAD TYPE)

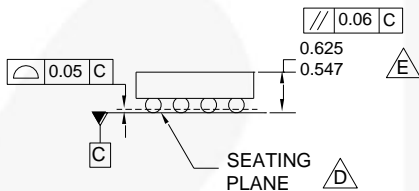

SIDE VIEWS

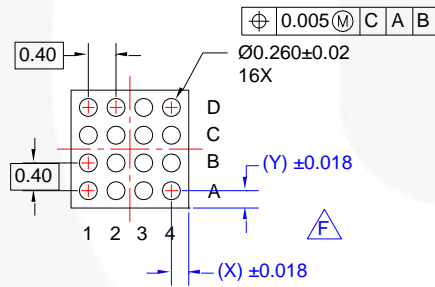
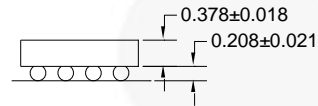

BOTTOM VIEW

NOTES:

- A. NO JEDEC REGISTRATION APPLIES.
- B. DIMENSIONS ARE IN MILLIMETERS.
- C. DIMENSIONS AND TOLERANCE PER ASME Y14.5M, 1994.
- D. DATUM C IS DEFINED BY THE SPHERICAL CROWNS OF THE BALLS.
- E. PACKAGE NOMINAL HEIGHT IS 586 MICRONS ±39 MICRONS (547-625 MICRONS).
- F. FOR DIMENSIONS D, E, X, AND Y SEE PRODUCT DATASHEET.
- G. DRAWING FILNAME: MKT-UC016AArev2.

Figure 16. Wafer-Level Chip-Scale Package (WLCSP)

Product-Specific Dimensions

Product	D	E	X	Y
FAN5701UCxx	1.610mm	1.610mm	0.205mm	0.205mm

Package drawings are provided as a service to customers considering Fairchild components. Drawings may change in any manner without notice. Please note the revision and/or date on the drawing and contact a Fairchild Semiconductor representative to verify or obtain the most recent revision. Package specifications do not expand the terms of Fairchild's worldwide terms and conditions, specifically the warranty therein, which covers Fairchild products.

Always visit Fairchild Semiconductor's online packaging area for the most recent package drawings:
<http://www.fairchildsemi.com/packaging/>

Physical Dimensions (Continued)

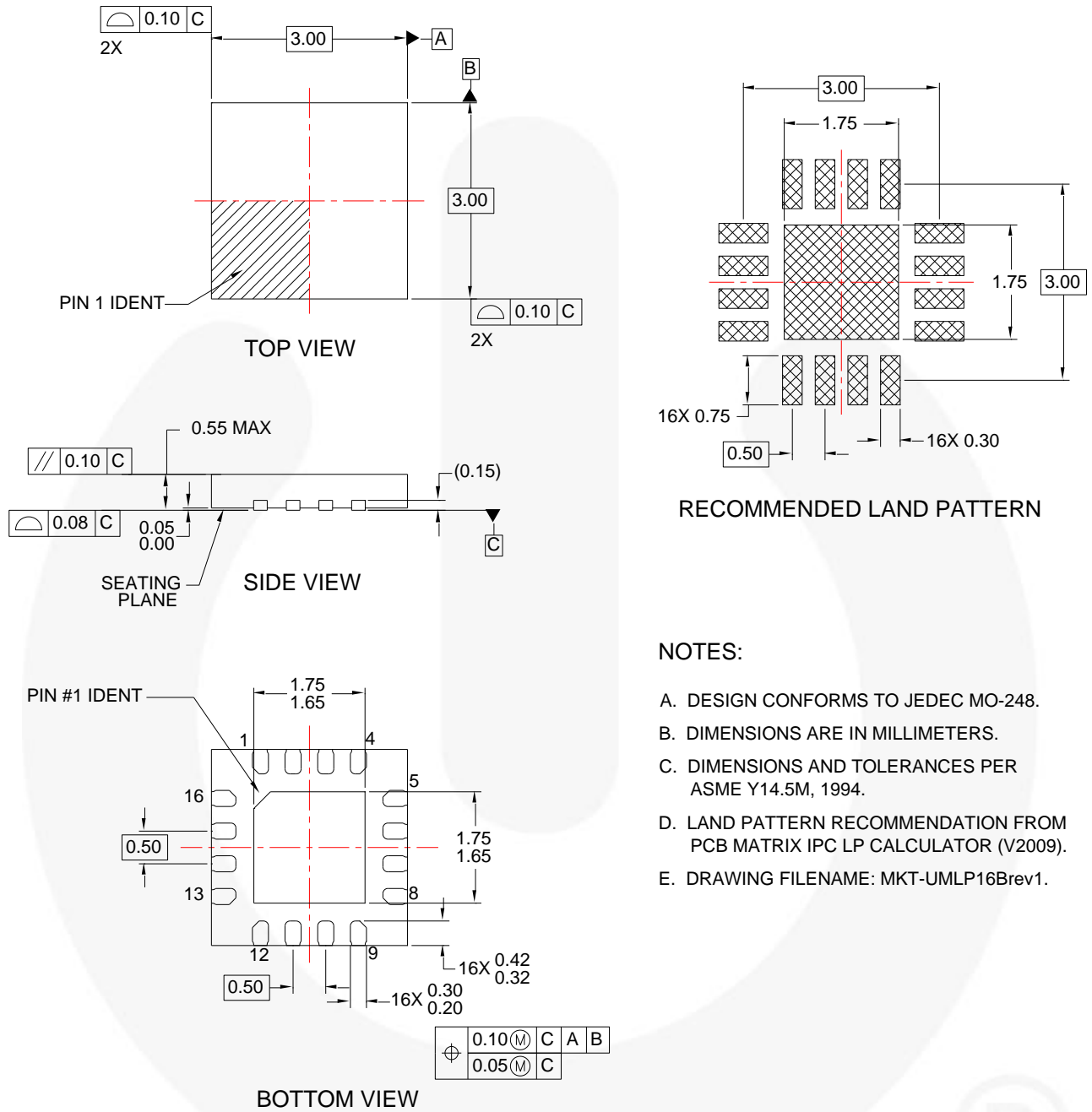

NOTES:

- A. DESIGN CONFORMS TO JEDEC MO-248.
- B. DIMENSIONS ARE IN MILLIMETERS.
- C. DIMENSIONS AND TOLERANCES PER ASME Y14.5M, 1994.
- D. LAND PATTERN RECOMMENDATION FROM PCB MATRIX IPC LP CALCULATOR (V2009).
- E. DRAWING FILENAME: MKT-UMLP16Brev1.

Figure 17. UMLP-16 Dimensions

Package drawings are provided as a service to customers considering Fairchild components. Drawings may change in any manner without notice. Please note the revision and/or date on the drawing and contact a Fairchild Semiconductor representative to verify or obtain the most recent revision. Package specifications do not expand the terms of Fairchild's worldwide terms and conditions, specifically the warranty therein, which covers Fairchild products.

Always visit Fairchild Semiconductor's online packaging area for the most recent package drawings:
<http://www.fairchildsemi.com/packaging/>.



TRADEMARKS

The following includes registered and unregistered trademarks and service marks, owned by Fairchild Semiconductor and/or its global subsidiaries, and is not intended to be an exhaustive list of all such trademarks.

- | | | | |
|--------------------------|------------------------|---------------------------------------|--|
| AccuPower™ | F-PFS™ | Power-SPM™ | <p>SYSTEM GENERAL®
The Power Franchise®</p> <p>power franchise™</p> <p>TinyBoost™</p> <p>TinyBuck™</p> <p>TinyCalc™</p> <p>TinyLogic™</p> <p>TINYOPTO™</p> <p>TinyPower™</p> <p>TinyPWM™</p> <p>TinyWire™</p> <p>TriFault Detect™</p> <p>TRUECURRENT™*</p> <p>µSerDes™</p> <p>SerDes™</p> <p>UHC®</p> <p>Ultra FRFET™</p> <p>UniFET™</p> <p>VCC™</p> <p>VisualMax™</p> <p>XST™</p> |
| Auto-SPM™ | FRFET® | PowerTrench® | |
| Build it Now™ | Global Power Resource™ | PowerXS™ | |
| CorePLUS™ | Green FPS™ | Programmable Active Droop™ | |
| CorePOWER™ | Green FPS™ e-Series™ | QFET® | |
| CROSSVOL™ | Gmax™ | QST™ | |
| CTL™ | GTO™ | Quiet Series™ | |
| Current Transfer Logic™ | IntelliMAX™ | RapidConfigure™ | |
| DEUXPEED® | ISOPLANAR™ | ™ | |
| Dual Cool™ | MegaBuck™ | Saving our world, 1mW/W/kW at a time™ | |
| EcoSPARK® | MICROCOUPLER™ | SignalWise™ | |
| EfficientMax™ | MicroFET™ | SmartMax™ | |
| ESBC™ | MicroPak™ | SMART START™ | |
| ™ | MicroPak2™ | SPM® | |
| Fairchild® | MillerDrive™ | STEALTH™ | |
| Fairchild Semiconductor® | MotionMax™ | SuperFET™ | |
| FACT Quiet Series™ | Motion-SPM™ | SuperSOT™-3 | |
| FACT® | OptoHIT™ | SuperSOT™-6 | |
| FAST® | OPTOLOGIC® | SuperSOT™-8 | |
| FastvCore™ | OPTOPLANAR® | SupreMOS® | |
| FETBench™ | ™ | SyncFET™ | |
| FlashWriter®* | PDP-SPM™ | Sync-Lock™ | |
| FPS™ | | | |

* Trademarks of System General Corporation, used under license by Fairchild Semiconductor.

DISCLAIMER

FAIRCHILD SEMICONDUCTOR RESERVES THE RIGHT TO MAKE CHANGES WITHOUT FURTHER NOTICE TO ANY PRODUCTS HEREIN TO IMPROVE RELIABILITY, FUNCTION, OR DESIGN. FAIRCHILD DOES NOT ASSUME ANY LIABILITY ARISING OUT OF THE APPLICATION OR USE OF ANY PRODUCT OR CIRCUIT DESCRIBED HEREIN; NEITHER DOES IT CONVEY ANY LICENSE UNDER ITS PATENT RIGHTS, NOR THE RIGHTS OF OTHERS. THESE SPECIFICATIONS DO NOT EXPAND THE TERMS OF FAIRCHILD'S WORLDWIDE TERMS AND CONDITIONS, SPECIFICALLY THE WARRANTY THEREIN, WHICH COVERS THESE PRODUCTS.

LIFE SUPPORT POLICY

FAIRCHILD'S PRODUCTS ARE NOT AUTHORIZED FOR USE AS CRITICAL COMPONENTS IN LIFE SUPPORT DEVICES OR SYSTEMS WITHOUT THE EXPRESS WRITTEN APPROVAL OF FAIRCHILD SEMICONDUCTOR CORPORATION.

As used herein:

- Life support devices or systems are devices or systems which, (a) are intended for surgical implant into the body or (b) support or sustain life, and (c) whose failure to perform when properly used in accordance with instructions for use provided in the labeling, can be reasonably expected to result in a significant injury of the user.
- A critical component in any component of a life support, device, or system whose failure to perform can be reasonably expected to cause the failure of the life support device or system, or to affect its safety or effectiveness.

ANTI-COUNTERFEITING POLICY

Fairchild Semiconductor Corporation's Anti-Counterfeiting Policy. Fairchild's Anti-Counterfeiting Policy is also stated on our external website, www.fairchildsemi.com, under Sales Support.

Counterfeiting of semiconductor parts is a growing problem in the industry. All manufacturers of semiconductor products are experiencing counterfeiting of their parts. Customers who inadvertently purchase counterfeit parts experience many problems such as loss of brand reputation, substandard performance, failed applications, and increased cost of production and manufacturing delays. Fairchild is taking strong measures to protect ourselves and our customers from the proliferation of counterfeit parts. Fairchild strongly encourages customers to purchase Fairchild parts either directly from Fairchild or from Authorized Fairchild Distributors who are listed by country on our web page cited above. Products customers buy either from Fairchild directly or from Authorized Fairchild Distributors are genuine parts, have full traceability, meet Fairchild's quality standards for handling and storage and provide access to Fairchild's full range of up-to-date technical and product information. Fairchild and our Authorized Distributors will stand behind all warranties and will appropriately address any warranty issues that may arise. Fairchild will not provide any warranty coverage or other assistance for parts bought from Unauthorized Sources. Fairchild is committed to combat this global problem and encourage our customers to do their part in stopping this practice by buying direct or from authorized distributors.

PRODUCT STATUS DEFINITIONS

Definition of Terms

Datasheet Identification	Product Status	Definition
Advance Information	Formative / In Design	Datasheet contains the design specifications for product development. Specifications may change in any manner without notice.
Preliminary	First Production	Datasheet contains preliminary data; supplementary data will be published at a later date. Fairchild Semiconductor reserves the right to make changes at any time without notice to improve design.
No Identification Needed	Full Production	Datasheet contains final specifications. Fairchild Semiconductor reserves the right to make changes at any time without notice to improve the design.
Obsolete	Not In Production	Datasheet contains specifications on a product that is discontinued by Fairchild Semiconductor. The datasheet is for reference information only.

Rev. I49

Mouser Electronics

Authorized Distributor

Click to View Pricing, Inventory, Delivery & Lifecycle Information:

Fairchild Semiconductor:

[FAN5701UMP15X](#) [FAN5701UC15X](#) [FAN5701UC08X](#) [FAN5701UMP08X](#) [FAN5701UC20X](#) [FAN5701UC30X](#)
[FAN5701UMP20X](#) [FAN5701UMP30X](#)