



Is Now Part of



**ON Semiconductor®**

To learn more about ON Semiconductor, please visit our website at

[www.onsemi.com](http://www.onsemi.com)

ON Semiconductor and the ON Semiconductor logo are trademarks of Semiconductor Components Industries, LLC dba ON Semiconductor or its subsidiaries in the United States and/or other countries. ON Semiconductor owns the rights to a number of patents, trademarks, copyrights, trade secrets, and other intellectual property. A listing of ON Semiconductor's product/patent coverage may be accessed at [www.onsemi.com/site/pdf/Patent-Marking.pdf](http://www.onsemi.com/site/pdf/Patent-Marking.pdf). ON Semiconductor reserves the right to make changes without further notice to any products herein. ON Semiconductor makes no warranty, representation or guarantee regarding the suitability of its products for any particular purpose, nor does ON Semiconductor assume any liability arising out of the application or use of any product or circuit, and specifically disclaims any and all liability, including without limitation special, consequential or incidental damages. Buyer is responsible for its products and applications using ON Semiconductor products, including compliance with all laws, regulations and safety requirements or standards, regardless of any support or applications information provided by ON Semiconductor. "Typical" parameters which may be provided in ON Semiconductor data sheets and/or specifications can and do vary in different applications and actual performance may vary over time. All operating parameters, including "Typicals" must be validated for each customer application by customer's technical experts. ON Semiconductor does not convey any license under its patent rights nor the rights of others. ON Semiconductor products are not designed, intended, or authorized for use as a critical component in life support systems or any FDA Class 3 medical devices or medical devices with a same or similar classification in a foreign jurisdiction or any devices intended for implantation in the human body. Should Buyer purchase or use ON Semiconductor products for any such unintended or unauthorized application, Buyer shall indemnify and hold ON Semiconductor and its officers, employees, subsidiaries, affiliates, and distributors harmless against all claims, costs, damages, and expenses, and reasonable attorney fees arising out of, directly or indirectly, any claim of personal injury or death associated with such unintended or unauthorized use, even if such claim alleges that ON Semiconductor was negligent regarding the design or manufacture of the part. ON Semiconductor is an Equal Opportunity/Affirmative Action Employer. This literature is subject to all applicable copyright laws and is not for resale in any manner.



# FPF1007-FPF1009 IntelliMAX™ Advanced Load Products

## Features

- 1.2 to 5.5 V Input Voltage Range
- Typical  $R_{ON} = 30\text{ m}\Omega$  at  $V_{IN} = 5.5\text{ V}$
- Typical  $R_{ON} = 40\text{ m}\Omega$  at  $V_{IN} = 3.3\text{ V}$
- Fixed Three Different Turn-on Rise Time  $10\text{ }\mu\text{s} / 80\text{ }\mu\text{s} / 1\text{ ms}$
- Low  $< 10\text{ }\mu\text{A}$  at  $V_{IN} = 3.3\text{ V}$  Quiescent Current
- Internal ON Pin Pull Down
- Output Discharge Function
- ESD Protection above 8000 V HBM and 2000 V CDM
- RoHS Compliant

## Applications

- PDAs
- Cell Phones
- GPS Devices
- MP3 Players
- Digital Cameras
- Peripheral Ports
- Hot-Swap Supplies
- Notebook Computers



## General Description

The FPF1007/8/9 are low  $R_{DS}$  P-Channel MOSFET load switches offered in a selection of  $10\text{ }\mu\text{s}$ ,  $80\text{ }\mu\text{s}$ , and  $1\text{ ms}$  slew rate turn-on options for transient / in-rush current control. To support trends in mobile application requirements, the minimum operating input voltage has been reduced down to  $1.2\text{ V}$ , the input current leakage has been minimized to extend battery life, and the ESD-protection has been designed to withstand a minimum of  $8\text{ kV}$  (HBM) and  $2\text{ kV}$  (CDM).

The switch is controlled by an active-high logic input (ON pin), allowing direct interface with a low-voltage control signal. An internal ON pin pull-down resistor protects against unintentional device turn-on in the initial state. An on-chip pull-down resistor on the output is enabled when the switch is turned-off and provides quick, robust discharge of the output load.



## Ordering Information

Part	Switch $R_{ON}$ at 5.5 V [Typ.]	Rise Time [Typ.]	Output Discharge [Typ.]	ON Pin Activity
FPF1007	$30\text{ m}\Omega$ , PMOS	$10\text{ }\mu\text{s}$	$60\text{ }\Omega$	Active HIGH
FPF1008	$30\text{ m}\Omega$ , PMOS	$80\text{ }\mu\text{s}$	$60\text{ }\Omega$	Active HIGH
FPF1009	$30\text{ m}\Omega$ , PMOS	$1\text{ ms}$	$60\text{ }\Omega$	Active HIGH

### Typical Application Circuit

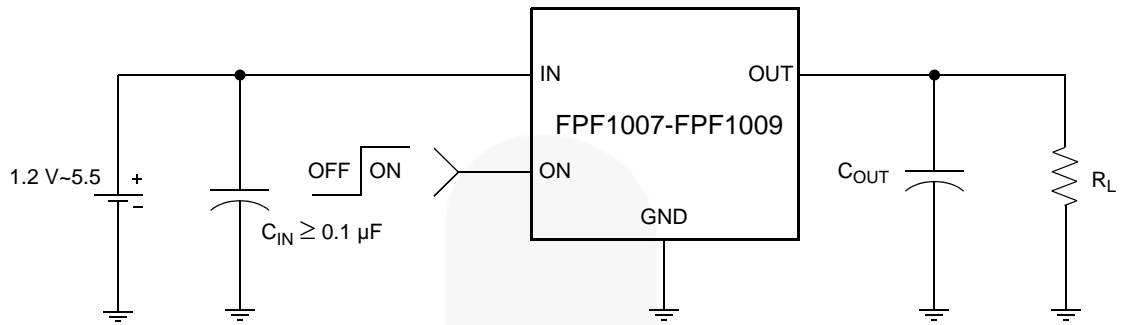

### Functional Block Diagram

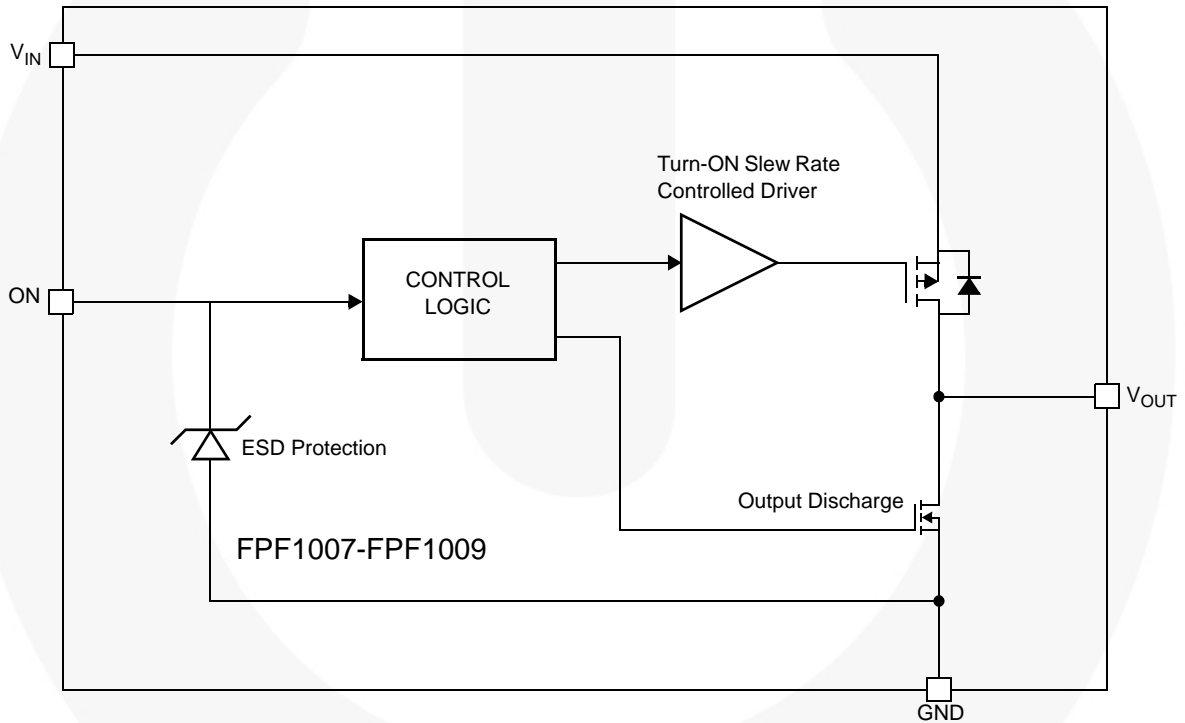

## Pin Configuration

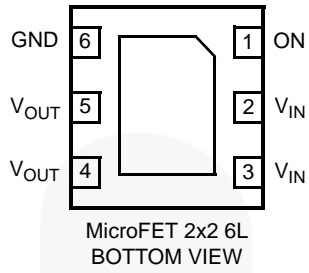

## Pin Description

Pin	Name	Function
4, 5	$V_{OUT}$	Switch Output: Output of the power switch
2, 3	$V_{IN}$	Supply Input: Input to the power switch and the supply voltage for the IC
6	GND	Ground
1	ON	ON/OFF Control Input

## Absolute Maximum Ratings

Parameter	Min.	Max.	Unit
$V_{IN}$ , $V_{OUT}$ , ON to GND	-0.3	6.0	V
Maximum Continuous Switch Current		1.5	A
Power Dissipation at $T_A = 25^\circ\text{C}^{(1)}$		1.2	W
Storage Junction Temperature	-65	+150	$^\circ\text{C}$
Operating Temperature Range	-40	+85	$^\circ\text{C}$
Thermal Resistance, Junction to Ambient		86	$^\circ\text{C/W}$
Electrostatic Discharge Protection	HBM	8000	V
	CDM	2000	V

**Note:**

Package power dissipation on 1-square inch pad, 2 oz. copper board.

## Recommended Operating Range

Parameter	Min.	Max.	Unit
$V_{IN}$	1.2	5.5	V
Ambient Operating Temperature, $T_A$	-40	+85	$^\circ\text{C}$

## Electrical Characteristics

$V_{IN} = 1.2\text{ V to } 5.5\text{ V}$ ,  $T_A = -40\text{ to } +85^\circ\text{C}$  unless otherwise noted. Typical values are at  $V_{IN} = 3.3\text{ V}$  and  $T_A = 25^\circ\text{C}$ .

Parameter	Symbol	Conditions	Min.	Typ.	Max.	Units
<b>Basic Operation</b>						
Operating Voltage	$V_{IN}$		1.2		5.5	V
Quiescent Current	$I_Q$	$I_{OUT} = 0\text{ mA}$ , $V_{IN} = 3.3\text{ V}$ , $V_{ON} = \text{Enabled}$		8		$\mu\text{A}$
		$I_{OUT} = 0\text{ mA}$ , $V_{IN} = 5.5\text{ V}$ , $V_{ON} = \text{Enabled}$			15	
Off Supply Current	$I_{Q(\text{off})}$	$V_{ON} = \text{GND}$ , $V_{OUT} = \text{OPEN}$			1	$\mu\text{A}$
Off Switch Current	$I_{SD(\text{off})}$	$V_{ON} = \text{GND}$ , $V_{OUT} = \text{GND}$		0.1	1.0	$\mu\text{A}$
On-Resistance	$R_{ON}$	$V_{IN} = 5.5\text{ V}$ , $I_{OUT} = 200\text{ mA}$ , $T_A = 25^\circ\text{C}$		30	40	$\text{m}\Omega$
		$V_{IN} = 3.3\text{ V}$ , $I_{OUT} = 200\text{ mA}$ , $T_A = 25^\circ\text{C}$		40	55	
		$V_{IN} = 1.5\text{ V}$ , $I_{OUT} = 200\text{ mA}$ , $T_A = 25^\circ\text{C}$		100	130	
		$V_{IN} = 1.2\text{ V}$ , $I_{OUT} = 200\text{ mA}$ , $T_A = 25^\circ\text{C}$		175	250	
		$V_{IN} = 3.3\text{ V}$ , $I_{OUT} = 200\text{ mA}$ , $T_A = -40^\circ\text{C to } +85^\circ\text{C}$	20		65	
Output Pull Down Resistance	$R_{PD}$	$V_{IN} = 3.3\text{ V}$ , $V_{ON} = 0\text{ V}$ , $T_A = 25^\circ\text{C}$		60		$\Omega$
ON Input Logic Low Voltage	$V_{IL}$	$V_{IN} = 1.2\text{ V to } 5.5\text{ V}$			0.4	V
ON Input Logic High Voltage	$V_{IH}$	$V_{IN} = 1.2\text{ V to } 5.5\text{ V}$	1			V
ON Input Leakage (On)		$V_{ON} = V_{IN} = 5.5\text{ V}$			10	$\mu\text{A}$
ON Input Leakage (Off)		$V_{ON} = \text{GND}$			1	$\mu\text{A}$
<b>Dynamic</b>						
<b>FPF1007</b>						
Turn On	$t_{ON}$	$V_{IN} = 3.3\text{ V}$ , $R_L = 500\ \Omega$ , $R_{L\_CHIP} = 60\ \Omega$ , $C_{OUT} = 0.1\ \mu\text{F}$ , $T_A = 25^\circ\text{C}$		12		$\mu\text{s}$
Rise Time	$t_R$			10		$\mu\text{s}$
Turn Off	$t_{OFF}$			40		$\mu\text{s}$
Fall Time	$t_F$			15		$\mu\text{s}$
<b>FPF1008</b>						
Turn On	$t_{ON}$	$V_{IN} = 3.3\text{ V}$ , $R_L = 500\ \Omega$ , $R_{L\_CHIP} = 60\ \Omega$ , $C_{OUT} = 0.1\ \mu\text{F}$ , $T_A = 25^\circ\text{C}$		125		$\mu\text{s}$
Rise Time	$t_R$			80		$\mu\text{s}$
Turn Off	$t_{OFF}$			40		$\mu\text{s}$
Fall Time	$t_F$			15		$\mu\text{s}$
<b>FPF1009</b>						
Turn On	$t_{ON}$	$V_{IN} = 3.3\text{ V}$ , $R_L = 500\ \Omega$ , $R_{L\_CHIP} = 60\ \Omega$ , $C_{OUT} = 0.1\ \mu\text{F}$ , $T_A = 25^\circ\text{C}$		2		ms
Rise Time	$t_R$			1		ms
Turn Off	$t_{OFF}$			40		$\mu\text{s}$
Fall Time	$t_F$			15		$\mu\text{s}$

## Typical Characteristics

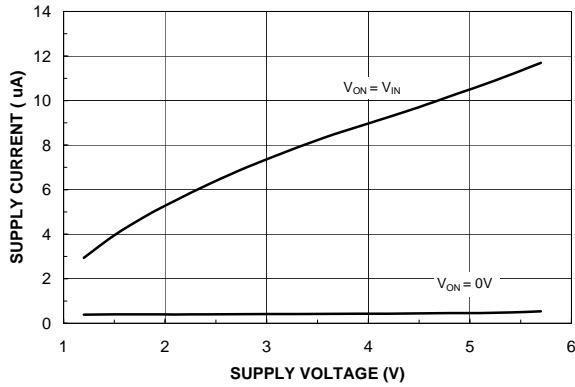

Figure 1. Quiescent Current vs. Input Voltage

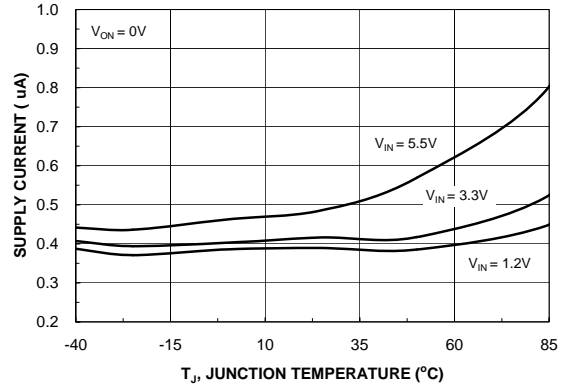

Figure 2. Quiescent Current vs. Temperature

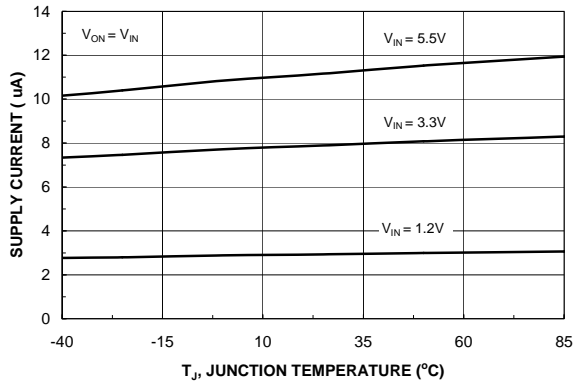

Figure 3. Quiescent Current vs. Temperature

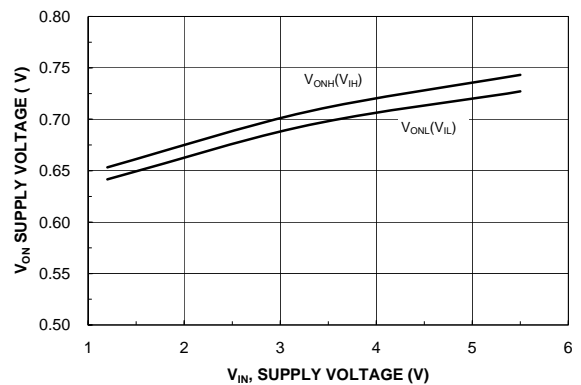

Figure 4.  $V_{ON}$  Voltage vs. Input Voltage

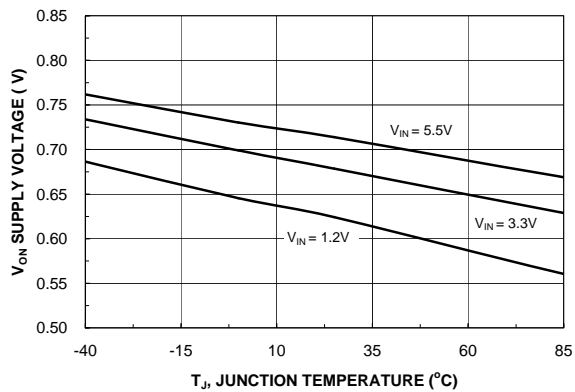

Figure 5.  $V_{ON}$  Low Voltage vs. Temperature

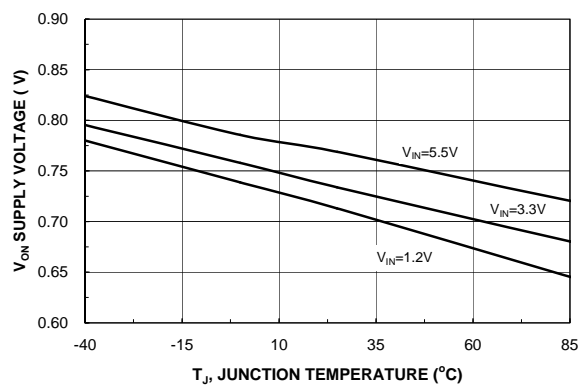

Figure 6.  $V_{ON}$  High Voltage vs. Temperature

## Typical Characteristics

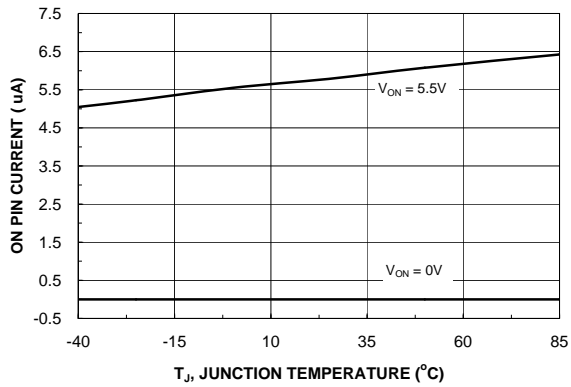

Figure 7. On Pin Current vs. Temperature

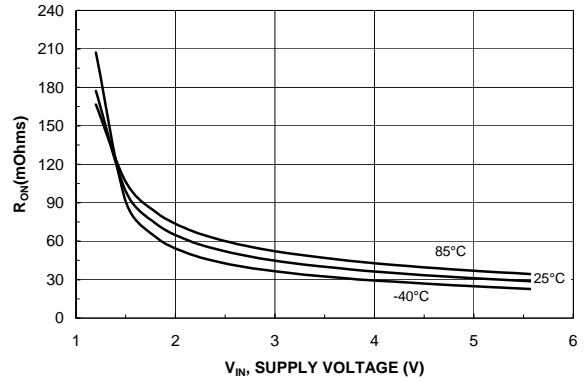

Figure 8.  $R_{ON}$  vs.  $V_{IN}$

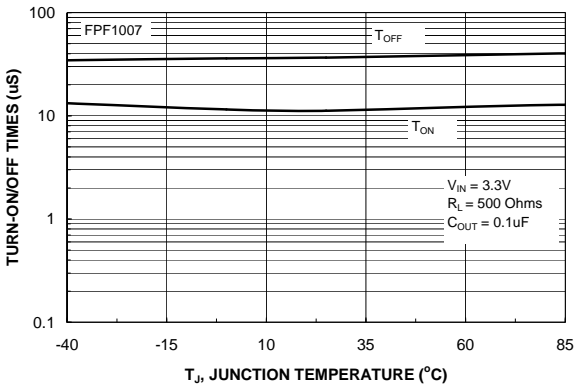

Figure 9. FPF1007  $t_{ON}$  /  $t_{OFF}$  vs. Temperature

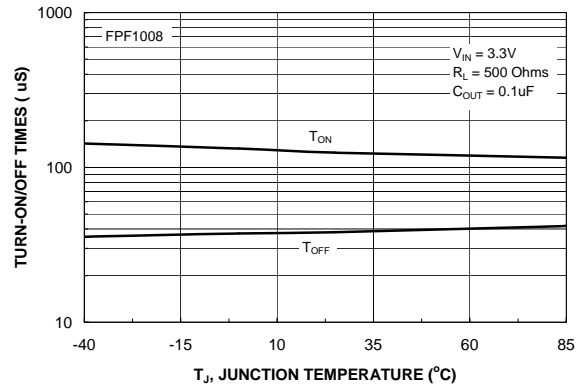

Figure 10. FPF1008  $t_{ON}$  /  $t_{OFF}$  vs. Temperature

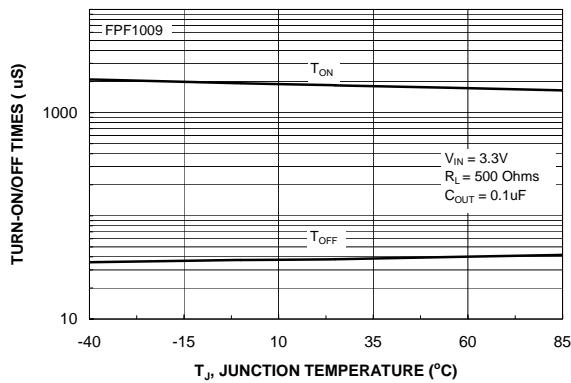

Figure 11. FPF1009  $t_{ON}$  /  $t_{OFF}$  vs. Temperature

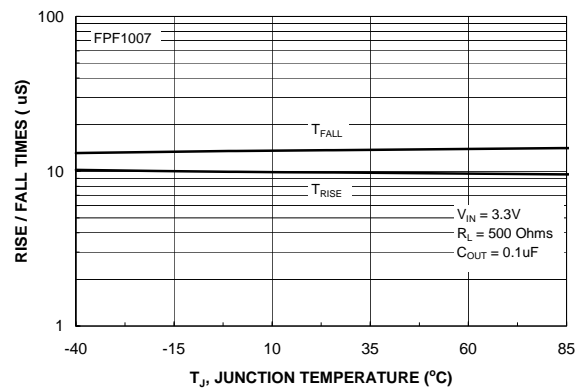

Figure 12. FPF1007  $t_{RISE}$  /  $t_{FALL}$  vs. Temperature



## Typical Characteristics

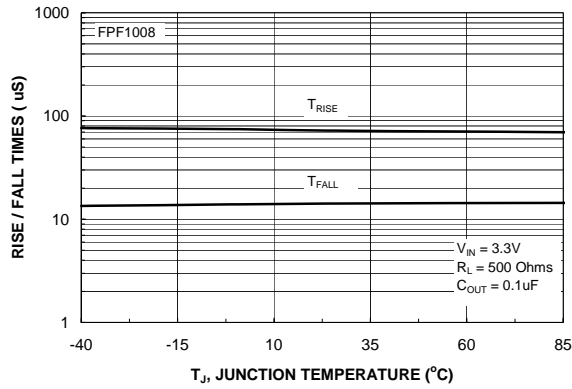

Figure 13. FPF1008  $t_{RISE} / t_{FALL}$  vs. Temperature

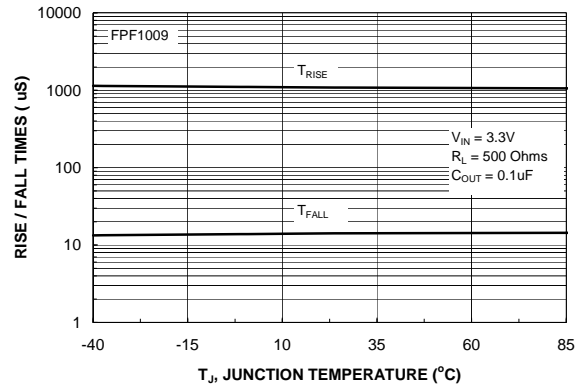

Figure 14. FPF1009  $t_{RISE} / t_{FALL}$  vs. Temperature

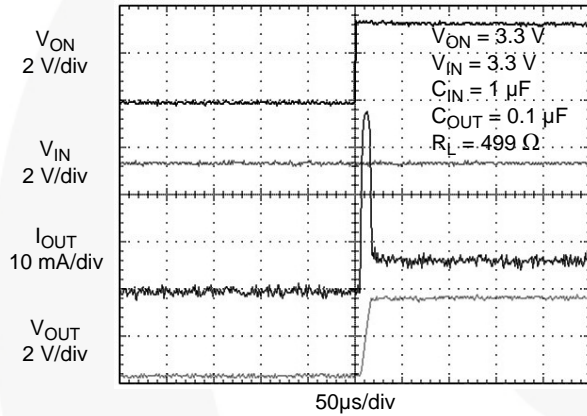

Figure 15. FPF1007 Turn-On Response

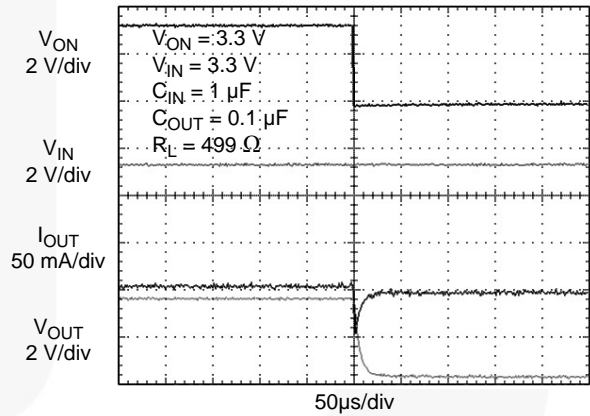

Figure 16. FPF1007 Turn-Off Response  
Load current discharged through on-chip output discharge resistor

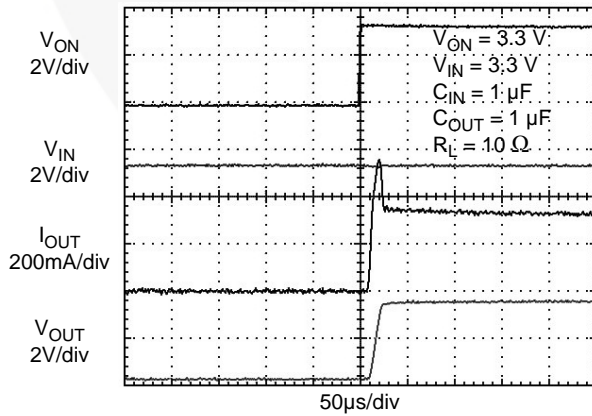

Figure 17. FPF1007 Turn-On Response ( $C_{OUT} = 1 \mu F$ )

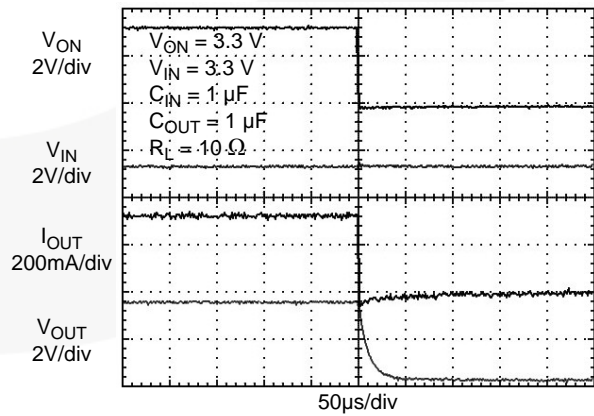

Figure 18. FPF1007 Turn-Off Response

## Typical Characteristics

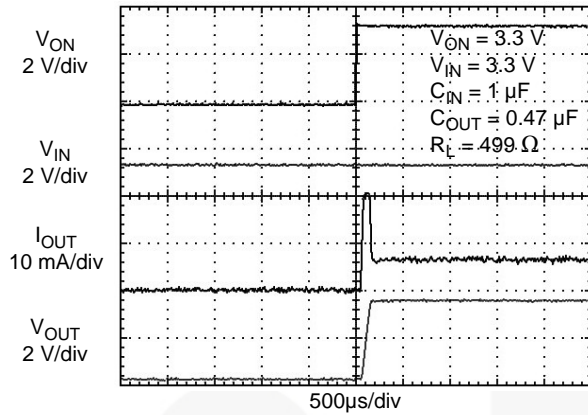

Figure 19. FPF1008 Turn-On Response

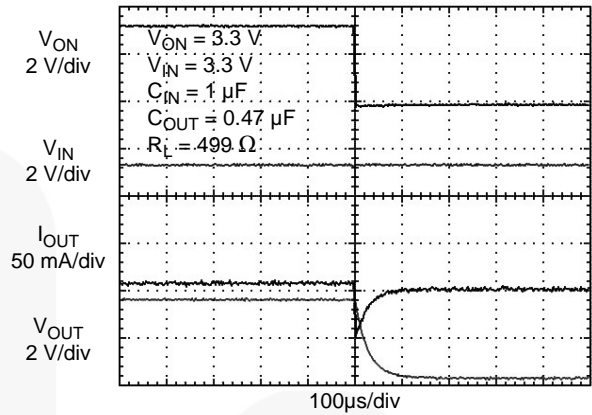

Figure 20. FPF1008 Turn-Off Response  
Load current discharged through on-chip output discharge resistor

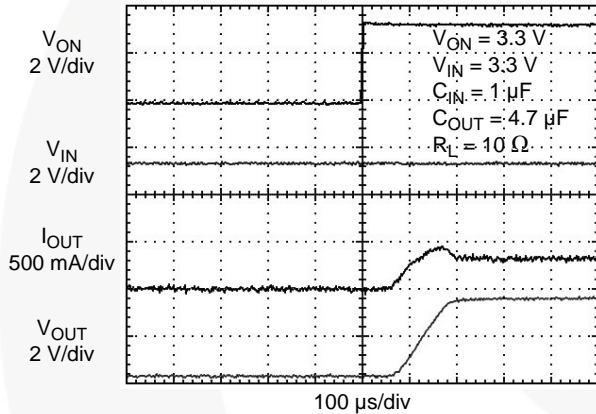

Figure 21. FPF1008 Turn-On Response ( $C_{OUT} = 4.7\text{ }\mu\text{F}$ )

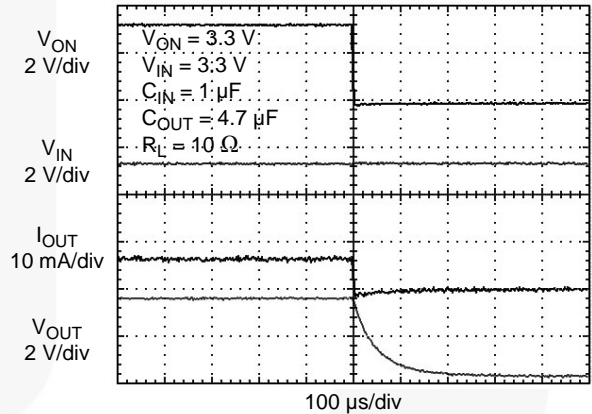

Figure 22. FPF1008 Turn-Off Response

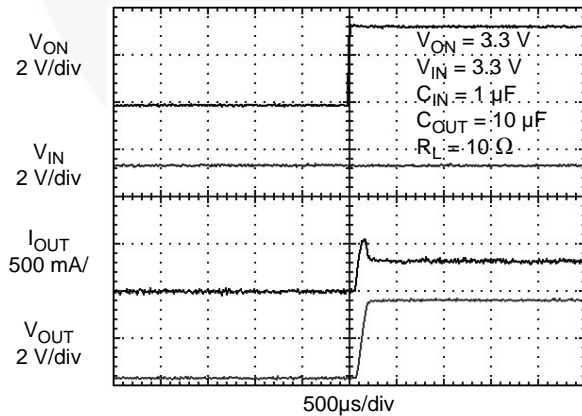

Figure 23. FPF1008 Turn-On Response ( $C_{OUT} = 10\text{ }\mu\text{F}$ )

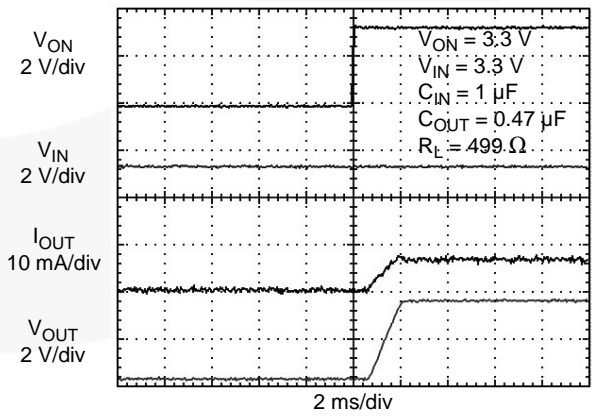

Figure 24. FPF1009 Turn-On Response

## Typical Characteristics

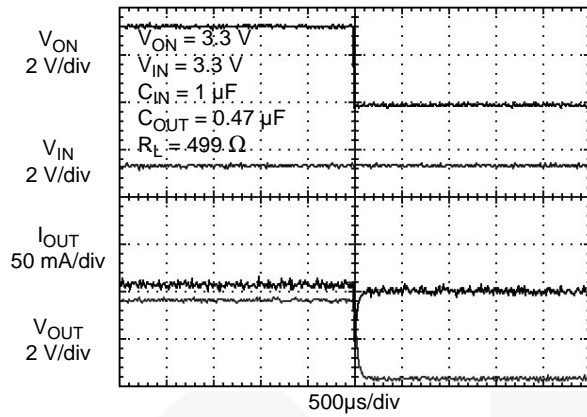

Figure 25. FPF1009 Turn-Off Response  
Load current discharged through on-chip output discharge resistor

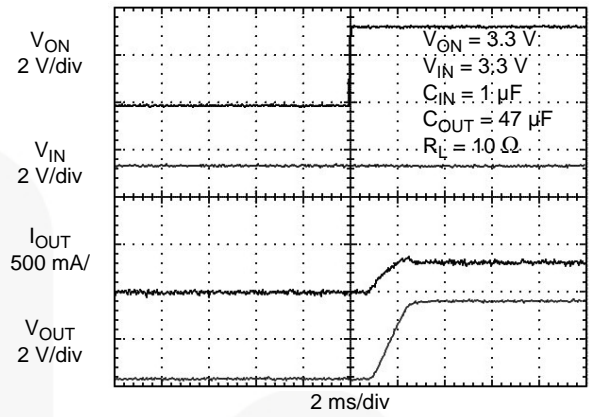

Figure 26. FPF1009 Turn-On Response ( $C_{OUT} = 47 \mu\text{F}$ )

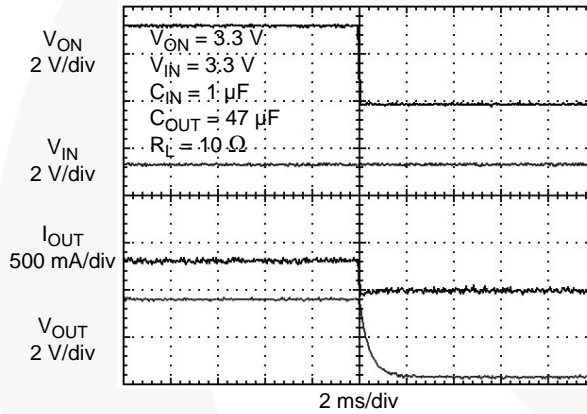

Figure 27. FPF1009 Turn-Off Response

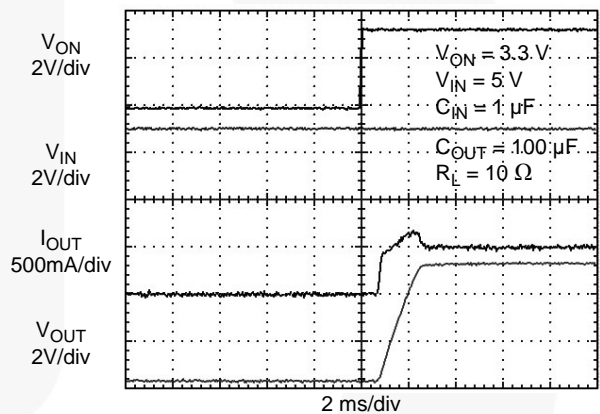
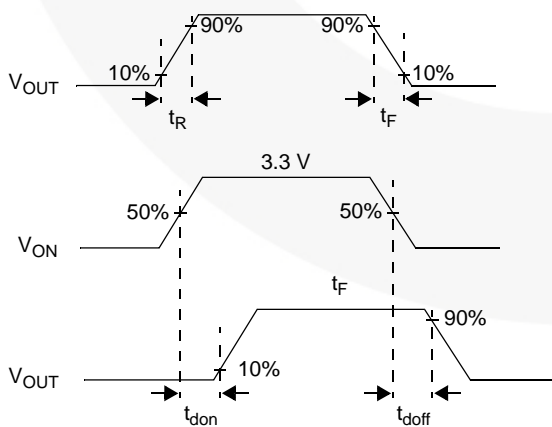

Figure 28. FPF1009 Turn-On Response  
( $C_{OUT} = 100 \mu\text{F}$ ,  $V_{IN} = 5\text{V}$ )

## Timing Diagram



where:

- $t_{ON}$  = Turn-On Time
- $t_{OFF}$  = Turn-Off Time
- $t_{don}$  = Turn-On Delay Time
- $t_{doff}$  = Turn-Off Delay Time
- $t_R$  = Rise Time
- $t_F$  =  $V_{OUT}$  Fall Time
- $t_{ON} = t_R + t_{don}$
- $t_{OFF} = t_F + t_{doff}$

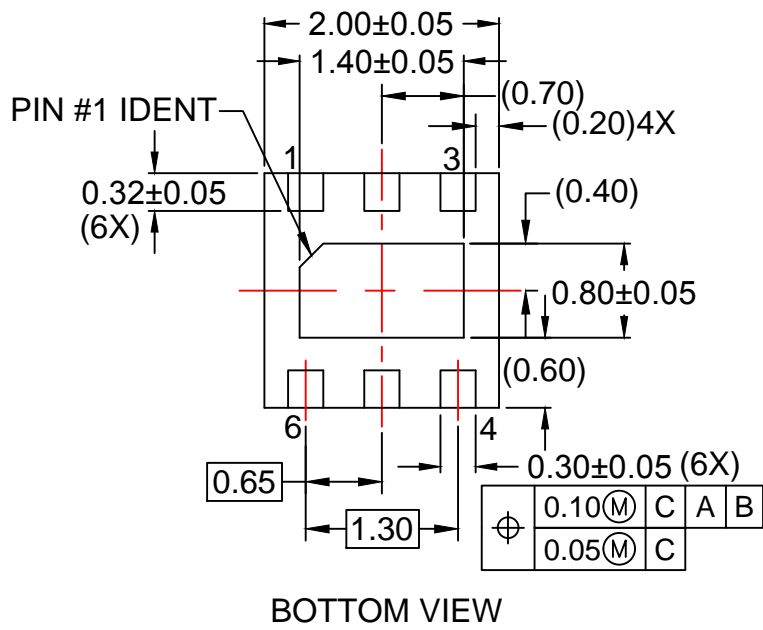
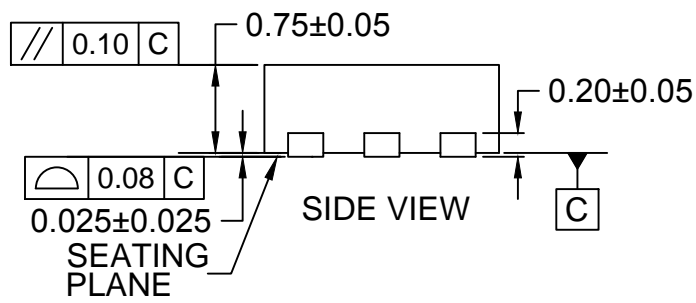
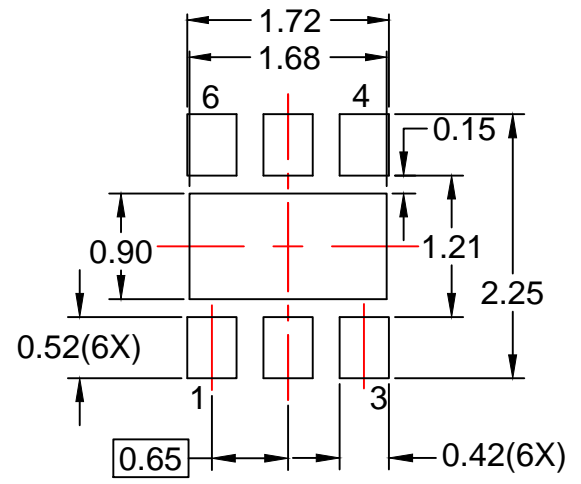
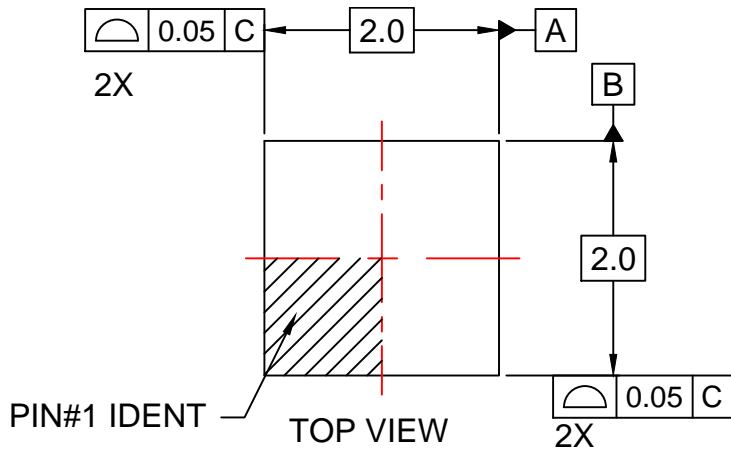

**NOTES:**

- A. PACKAGE DOES NOT FULLY CONFORM TO JEDEC MO-229 REGISTRATION
- B. DIMENSIONS ARE IN MILLIMETERS.
- C. DIMENSIONS AND TOLERANCES PER ASME Y14.5M, 2009.
- D. LAND PATTERN RECOMMENDATION IS EXISTING INDUSTRY LAND PATTERN.
- E. DRAWING FILENAME: MKT-MLP06Krev5.





**TRADEMARKS**

The following includes registered and unregistered trademarks and service marks, owned by Fairchild Semiconductor and/or its global subsidiaries, and is not intended to be an exhaustive list of all such trademarks.

- AccuPower™
- AttitudeEngine™
- Awinda®
- AX-CAP®\*
- BitSiC™
- Build it Now™
- CorePLUS™
- CorePOWER™
- CROSSVOL™
- CTL™
- Current Transfer Logic™
- DEUXPEED®
- Dual Cool™
- EcoSPARK®
- EfficientMax™
- ESBC™
- F**™
- Fairchild®
- Fairchild Semiconductor®
- FACT Quiet Series™
- FACT®
- FastvCore™
- FETBench™
- FPS™
- F-PFS™
- FRFET®
- Global Power Resource<sup>SM</sup>
- GreenBridge™
- Green FPS™
- Green FPS™ e-Series™
- Gmax™
- GTO™
- IntelliMAX™
- ISOPLANAR™
- Making Small Speakers Sound Louder and Better™
- MegaBuck™
- MICROCOUPLER™
- MicroFET™
- MicroPak™
- MicroPak2™
- MillerDrive™
- MotionMax™
- MotionGrid®
- MTi®
- MTx®
- MVN®
- mWSaver®
- OptoHiT™
- OPTOLOGIC®
- OPTOPLANAR®
- ®
- Power Supply WebDesigner™
- PowerTrench®
- PowerXS™
- Programmable Active Droop™
- QFET®
- QS™
- Quiet Series™
- RapidConfigure™
- ™
- Saving our world, 1mW/W/kW at a time™
- SignalWise™
- SmartMax™
- SMART START™
- Solutions for Your Success™
- SPM®
- STEALTH™
- SuperFET®
- SuperSOT™-3
- SuperSOT™-6
- SuperSOT™-8
- SupreMOS®
- SyncFET™
- Sync-Lock™
- ®
- TinyBoost®
- TinyBuck®
- TinyCalc™
- TinyLogic®
- TINYOPTO™
- TinyPower™
- TinyPWM™
- TinyWire™
- TranSiC™
- TriFault Detect™
- TRUECURRENT®\*
- μSerDes™
- ™
- UHC®
- Ultra FRFET™
- UniFET™
- VcX™
- VisualMax™
- VoltagePlus™
- XS™
- Xsens™
- 仙童®

\* Trademarks of System General Corporation, used under license by Fairchild Semiconductor.

**DISCLAIMER**

FAIRCHILD SEMICONDUCTOR RESERVES THE RIGHT TO MAKE CHANGES WITHOUT FURTHER NOTICE TO ANY PRODUCTS HEREIN TO IMPROVE RELIABILITY, FUNCTION, OR DESIGN. TO OBTAIN THE LATEST, MOST UP-TO-DATE DATASHEET AND PRODUCT INFORMATION, VISIT OUR WEBSITE AT [HTTP://WWW.FAIRCHILDSEMI.COM](http://www.fairchildsemi.com). FAIRCHILD DOES NOT ASSUME ANY LIABILITY ARISING OUT OF THE APPLICATION OR USE OF ANY PRODUCT OR CIRCUIT DESCRIBED HEREIN; NEITHER DOES IT CONVEY ANY LICENSE UNDER ITS PATENT RIGHTS, NOR THE RIGHTS OF OTHERS. THESE SPECIFICATIONS DO NOT EXPAND THE TERMS OF FAIRCHILD'S WORLDWIDE TERMS AND CONDITIONS, SPECIFICALLY THE WARRANTY THEREIN, WHICH COVERS THESE PRODUCTS.

**AUTHORIZED USE**

Unless otherwise specified in this data sheet, this product is a standard commercial product and is not intended for use in applications that require extraordinary levels of quality and reliability. This product may not be used in the following applications, unless specifically approved in writing by a Fairchild officer: (1) automotive or other transportation, (2) military/aerospace, (3) any safety critical application – including life critical medical equipment – where the failure of the Fairchild product reasonably would be expected to result in personal injury, death or property damage. Customer's use of this product is subject to agreement of this Authorized Use policy. In the event of an unauthorized use of Fairchild's product, Fairchild accepts no liability in the event of product failure. In other respects, this product shall be subject to Fairchild's Worldwide Terms and Conditions of Sale, unless a separate agreement has been signed by both Parties.

**ANTI-COUNTERFEITING POLICY**

Fairchild Semiconductor Corporation's Anti-Counterfeiting Policy. Fairchild's Anti-Counterfeiting Policy is also stated on our external website, [www.fairchildsemi.com](http://www.fairchildsemi.com), under Terms of Use

Counterfeiting of semiconductor parts is a growing problem in the industry. All manufacturers of semiconductor products are experiencing counterfeiting of their parts. Customers who inadvertently purchase counterfeit parts experience many problems such as loss of brand reputation, substandard performance, failed applications, and increased cost of production and manufacturing delays. Fairchild is taking strong measures to protect ourselves and our customers from the proliferation of counterfeit parts. Fairchild strongly encourages customers to purchase Fairchild parts either directly from Fairchild or from Authorized Fairchild Distributors who are listed by country on our web page cited above. Products customers buy either from Fairchild directly or from Authorized Fairchild Distributors are genuine parts, have full traceability, meet Fairchild's quality standards for handling and storage and provide access to Fairchild's full range of up-to-date technical and product information. Fairchild and our Authorized Distributors will stand behind all warranties and will appropriately address any warranty issues that may arise. Fairchild will not provide any warranty coverage or other assistance for parts bought from Unauthorized Sources. Fairchild is committed to combat this global problem and encourage our customers to do their part in stopping this practice by buying direct or from authorized distributors.

**PRODUCT STATUS DEFINITIONS**

**Definition of Terms**

Datasheet Identification	Product Status	Definition
Advance Information	Formative / In Design	Datasheet contains the design specifications for product development. Specifications may change in any manner without notice.
Preliminary	First Production	Datasheet contains preliminary data; supplementary data will be published at a later date. Fairchild Semiconductor reserves the right to make changes at any time without notice to improve design.
No Identification Needed	Full Production	Datasheet contains final specifications. Fairchild Semiconductor reserves the right to make changes at any time without notice to improve the design.
Obsolete	Not In Production	Datasheet contains specifications on a product that is discontinued by Fairchild Semiconductor. The datasheet is for reference information only.

Rev. I77

# Mouser Electronics

Authorized Distributor

Click to View Pricing, Inventory, Delivery & Lifecycle Information:

[Fairchild Semiconductor:](#)

[FPF1007](#)