



Is Now Part of



ON Semiconductor®

To learn more about ON Semiconductor, please visit our website at
www.onsemi.com

ON Semiconductor and the ON Semiconductor logo are trademarks of Semiconductor Components Industries, LLC dba ON Semiconductor or its subsidiaries in the United States and/or other countries. ON Semiconductor owns the rights to a number of patents, trademarks, copyrights, trade secrets, and other intellectual property. A listing of ON Semiconductor's product/patent coverage may be accessed at www.onsemi.com/site/pdf/Patent-Marking.pdf. ON Semiconductor reserves the right to make changes without further notice to any products herein. ON Semiconductor makes no warranty, representation or guarantee regarding the suitability of its products for any particular purpose, nor does ON Semiconductor assume any liability arising out of the application or use of any product or circuit, and specifically disclaims any and all liability, including without limitation special, consequential or incidental damages. Buyer is responsible for its products and applications using ON Semiconductor products, including compliance with all laws, regulations and safety requirements or standards, regardless of any support or applications information provided by ON Semiconductor. "Typical" parameters which may be provided in ON Semiconductor data sheets and/or specifications can and do vary in different applications and actual performance may vary over time. All operating parameters, including "Typicals" must be validated for each customer application by customer's technical experts. ON Semiconductor does not convey any license under its patent rights nor the rights of others. ON Semiconductor products are not designed, intended, or authorized for use as a critical component in life support systems or any FDA Class 3 medical devices or medical devices with a same or similar classification in a foreign jurisdiction or any devices intended for implantation in the human body. Should Buyer purchase or use ON Semiconductor products for any such unintended or unauthorized application, Buyer shall indemnify and hold ON Semiconductor and its officers, employees, subsidiaries, affiliates, and distributors harmless against all claims, costs, damages, and expenses, and reasonable attorney fees arising out of, directly or indirectly, any claim of personal injury or death associated with such unintended or unauthorized use, even if such claim alleges that ON Semiconductor was negligent regarding the design or manufacture of the part. ON Semiconductor is an Equal Opportunity/Affirmative Action Employer. This literature is subject to all applicable copyright laws and is not for resale in any manner.



May 2014



FTL75939 Configurable Reset Timer with Integrated Load Switch

Features

- Factory Programmed Reset Delay: 7.5 s
- Factory Programmed Reset Pulse: 400 ms
- Factory Customized Turn-on Time: 2.3 s
- Factory Customized Turn-off Delay: 7.3 s
- Adjustable Reset Delay Option with External Resistor
- Low I_{CC}T Saves Power Interfacing to Low-Voltage Chips
- Off Pin Turns Off Load Switch to Maintain Battery Charge during Shipment and Inventory. Ready to use Right Out of the Box
- Input Voltage Operating Range: 1.2 V to 5.5 V
- Over-Voltage Protection: Allow Input Pins > V_{BAT}
- Typical R_{ON}: 21 mΩ (Typ.) at V_{BAT}=4.5 V
- Slew Rate / Inrush Control with t_R: 2.7 ms (Typical)
- 3.8 A / 4.5 A Maximum Continuous Current (JEDEC 2S2P, No VIA / with Thermal VIA)
- Output Capacitor Discharge Function
- Zero-Second Test-Mode Enable
- Low < 0.2 μA Typical Shutdown Current
- IEC61000-4-2, , Level 4 compliant SYS_WAKE Pin
- ESD Protected:
 - 8 kV HBM ESD (per JESD22-A114)
 - 10 kV HBM ESD (Pin to Pin, V_{BAT} & V_{OUT})
 - 2 kV CDM (per JESD22-C101)

Applications

- Smart Phones, Tablet PCs
- Storage, DSLR, and Portable Devices

Description

The FTL75939 is both a timer for resetting a mobile device and an advanced load management switch for applications requiring a highly integrated solution.

If the mobile device is off, holding /SR0 LOW (by pressing power-on key) for 2.3 s ±20% turns on the PMIC.

As a reset timer, it has one input and one fixed delay output. It generates a fixed delay of 7.5 s ±20% by disconnecting the PMIC from the battery power supply for 400 ms ±20%. Then the load switch is turned on again to reconnect the battery to the PMIC such that PMIC goes into power-on sequence. The reset delay can be customized by connecting an external resistor to the DELAY_ADJ pin. Refer to Table 4.

As an advanced load management switch, the FTL75939 disconnects loads powered from the DC power rail (<6 V) with stringent off-state current targets and high load capacitances (up to 200 μF). The FTL75939 consists of a slew-rate controlled low-impedance MOSFET switch (21 mΩ typical at 4.5 V) that has exceptionally low off-state current drain (<0.2 μA Typical) to facilitate compliance with standby power requirements. The slew-rate-controlled turn-on characteristic prevents inrush current and the resulting excessive voltage drop on power rails.

The low I_{CC}T enables direct interface to lower-voltage chipsets without external translation, while maintaining low power consumption.

The device is packaged in advanced, fully green, 1.31 mm x 1.62 mm, Wafer-Level Chip-Scale Packaging (WLCSP) with backside laminate; providing excellent thermal conductivity, small footprint, and low electrical resistance for a wide application range.

Related Resources

For additional information, please contact:
<http://www.fairchildsemi.com/cf/#Regional-Sales>

Ordering Information

Part Number	Top Mark	Operating Temperature Range	Package	Packing Method
FTL75939UCX	UA	-40 to +85°C	12-Ball WLCSP (with backside laminate), 3x4 Array, 0.4 mm Pitch, 250 μm Ball, Nominal: 1.31 mm x 1.62 mm	3000 Units on Tape and Reel

Application Diagram

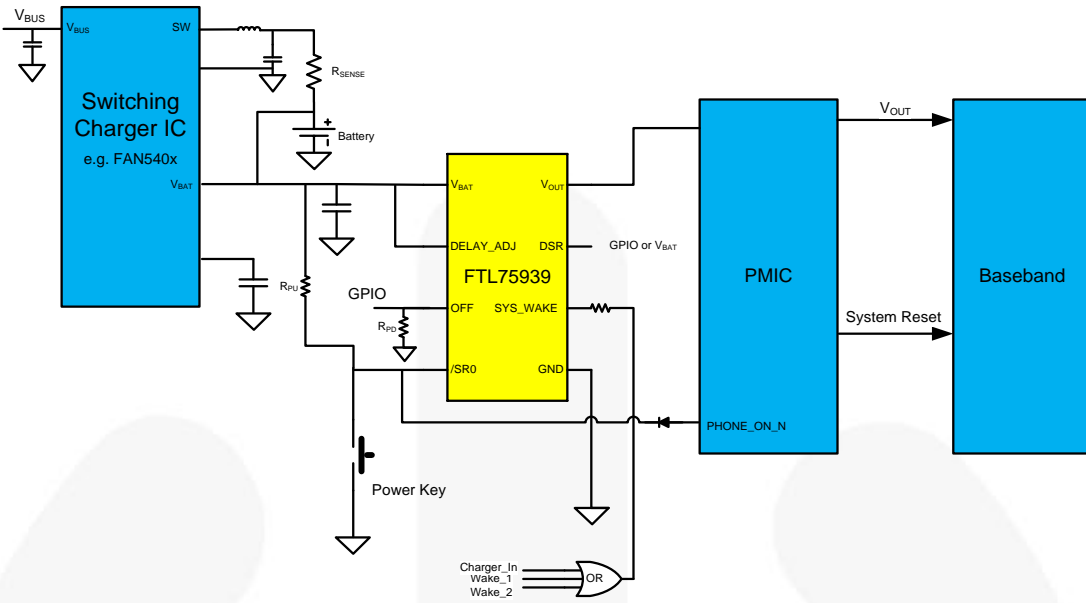

Figure 1. Typical Application with Stand Alone Switching Charger IC

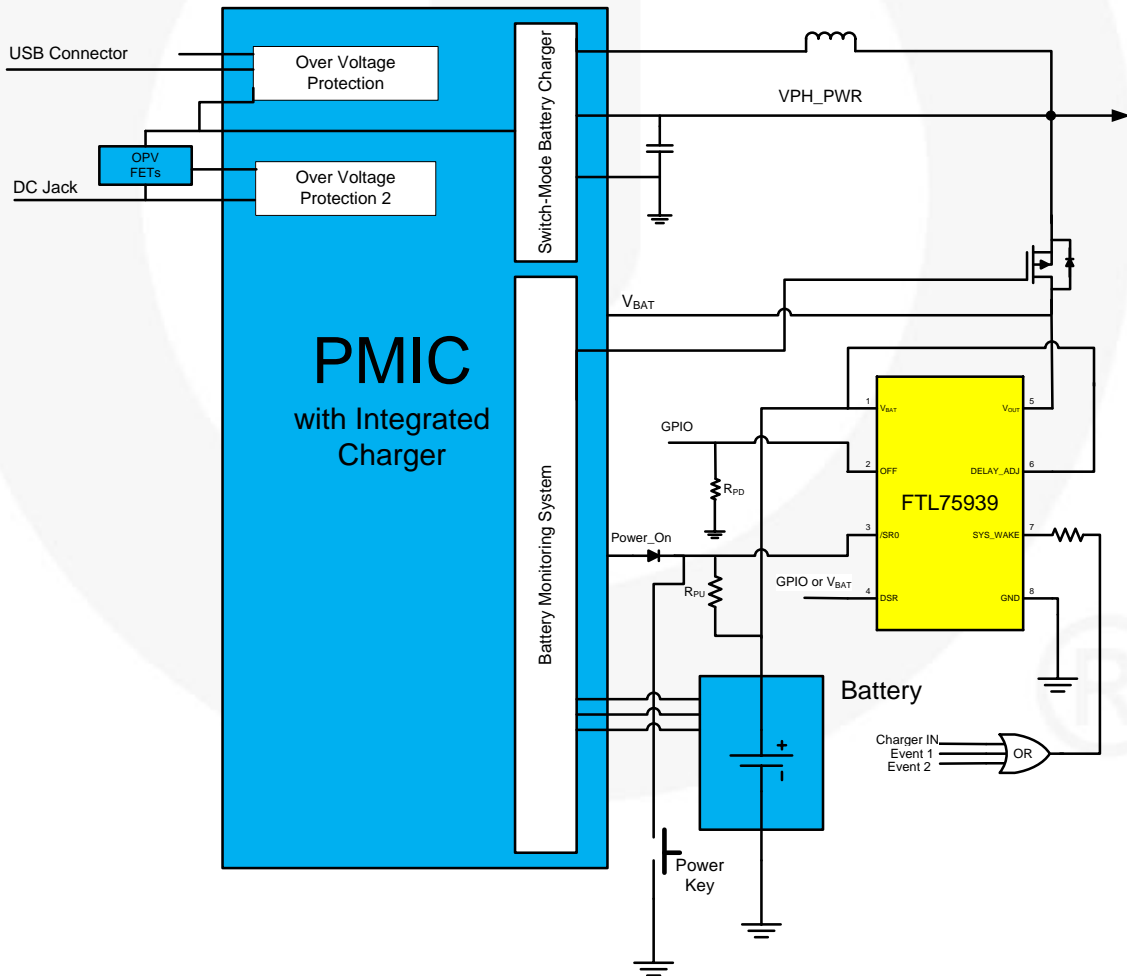

Figure 2. Typical Application PMIC with Integrated Charger

Functional Block Diagram

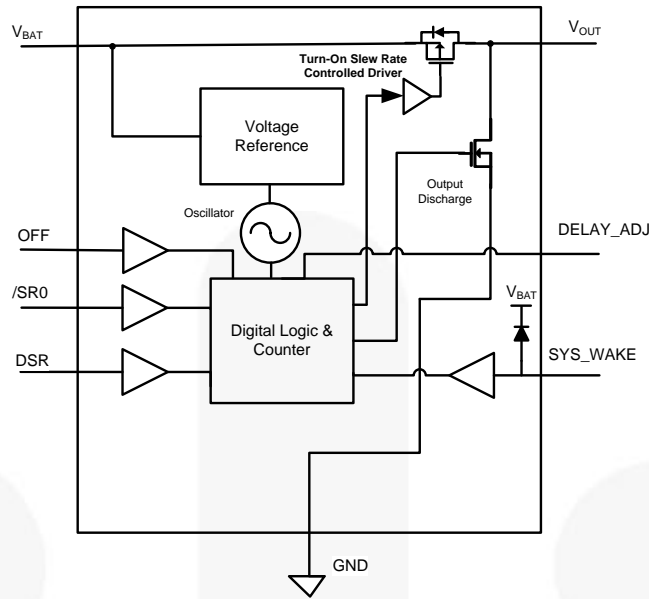

Figure 3. Block Diagram

Pin Configuration

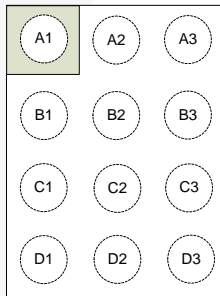

Figure 4. Top View

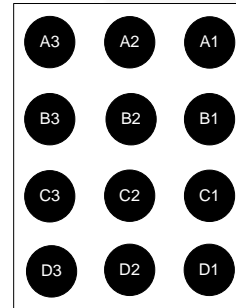

Figure 5. Bottom View

Pin Definitions

Pin #	Name	Description	
		Normal Operation	0-Second Factory-Test Mode ⁽¹⁾
A1, A2, A3	V _{OUT}	Switch Output	Switch Output
B1, B2, B3	V _{BAT}	Supply Input	Supply Input
C1	GND	Ground	Ground
C2	DSR	Delay selection input; connected to GPIO with 100 K pull-up or to V _{BAT} directly without pull-up resistor	Logic LOW
C3	/SR0	Power-on or reset input; active LOW.	Logic LOW
D1	DELAY_ADJ	Reset delay adjustment; MUST tie to V _{BAT} directly if not used. To adjust the reset delay, a resistor (R _{ADJ}) is connected between this pin and ground	Connected to V _{BAT} or GND
D2	OFF	Load switch disable; Rising Edge Triggered; changes load switch from ON state to OFF state.	Don't Care
D3	SYS_WAKE	System wake-up input; changes load switch from OFF state to ON state	Don't Care

Note:

- 0-Second Factory Test Mode is for t_{VON} and t_{PHL1} only.

Absolute Maximum Ratings

Stresses exceeding the absolute maximum ratings may damage the device. The device may not function or be operable above the recommended operating conditions and stressing the parts to these levels is not recommended. In addition, extended exposure to stresses above the recommended operating conditions may affect device reliability. The absolute maximum ratings are stress ratings only.

Symbol	Parameters	Condition	Min.	Max.	Unit
V_{BAT}	V_{BAT} to GND		-0.3	6.5	V
V_{OUT}	V_{OUT} to GND				
I_{SW}	Maximum Continuous Switch Current	2S2P JEDEC std. PCB		3.8	A
		2S2P + Thermal VIA JEDEC std. PCB		4.5	
P_D	Power Dissipation	$I_{OUT}=4.5$ A, $R_{ON} = 20$ m Ω (max)		0.41	W
V_{IN}	DC Input Voltage	/SR0, DSR, OFF, DELAY_ADJ	-0.5	6.5	V
		SYS_WAKE ⁽²⁾		$V_{BAT}+0.3$	
I_{IK}	DC Input Diode Current	$V_{BAT} < 0$ V		-50	mA
I_{CC}	DC V_{CC} or Ground Current per Supply Pin			± 100	mA
T_{STG}	Storage Temperature Range		-65	+150	$^{\circ}$ C
T_J	Junction Temperature Under Bias			+150	$^{\circ}$ C
T_L	Junction Lead Temperature, Soldering 10 Seconds			+260	$^{\circ}$ C
Θ_{JA}	Thermal Resistance, Junction-to-Ambient	2S2P JEDEC std. PCB		86	$^{\circ}$ C/W
		2S2P + Thermal VIA JEDEC std. PCB		48	
Θ_{JC}	Thermal Resistance, Junction-to-Case ⁽³⁾			10.9	$^{\circ}$ C/W
ESD	Human Body Model, JEDEC: JESD22-A114	All Pins		8	kV
	Human Body Model, Pin to Pin ⁽⁴⁾	V_{BAT} , V_{OUT}		10	
	IEC 61000-2-4, Level 4, for SYS_WAKE ⁽⁵⁾	Air		15	
		Contact		8	
	Charged Device Model, JESD22-C101			2	

Notes:

- SYS_WAKE operates up to 28 V if an external resistor is attached. A value of 100 k Ω is typically recommended.
- Uniform temperature at bottom solder.
- Test conditions: V_{BAT} vs. GND and V_{OUT} vs. GND.
- A 100 k Ω resistor is required between SYS_WAKE and USB Charger In.

Recommended Operating Conditions

The Recommended Operating Conditions table defines the conditions for actual device operation. Recommended operating conditions are specified to ensure optimal performance to the datasheet specifications. Fairchild does not recommend exceeding them or designing to Absolute Maximum Ratings.

Symbol	Parameters	Condition	Min.	Max.	Unit
V_{BAT}	Input Voltage ⁽⁶⁾	V_{BAT}	1.2	5.5	V
V_{IN}		/SR0, DSR, OFF	0		
		SYS_WAKE	0	V_{BAT}	
V_{OUT}	Output Voltage		0	5.5	V
t_{RFC}	V_{BAT} Recovery Time After Power Down	$V_{BAT}=0$ V After Power Down, Rising to 0.5 V	5		ms
T_A	Free-Air Operating Temperature		-40	+85	$^{\circ}$ C

Note:

- V_{BAT} should never be allowed to float while input pins are driven.

Electrical Characteristics

Unless otherwise noted, $V_{BAT}=1.2$ to 5.5 V and $T_A=-40$ to $+85^\circ\text{C}$; typical values are at $V_{BAT}=4.5$ V and $T_A=25^\circ\text{C}$.

Symbol	Parameters	Conditions	Min.	Typ.	Max.	Unit
Basic Operation						
I_{OFF}	Off Supply Current	$V_{BAT}=4.5$ V, $V_{OUT}=\text{Open}$, Load Switch=OFF			5.5	μA
I_{SD}	Shutdown Current	$V_{BAT}=4.5$ V, $V_{OUT}=\text{GND}$, Load Switch=OFF		0.2	5.5	μA
		$V_{BAT}=3.8$ V, $V_{OUT}=\text{GND}$, Load Switch=OFF		0.1	4.5	
R_{ON}	On Resistance	$V_{BAT}=5.5$ V, $I_{OUT}=1$ A ⁽⁷⁾		20	24	$\text{m}\Omega$
		$V_{BAT}=4.5$ V, $I_{OUT}=1$ A, $T_A=25^\circ\text{C}$ ⁽⁷⁾		21	25	
		$V_{BAT}=3.3$ V, $I_{OUT}=500$ mA ⁽⁷⁾		24	29	
		$V_{BAT}=2.5$ V, $I_{OUT}=500$ mA ⁽⁷⁾		28	35	
		$V_{BAT}=1.8$ V, $I_{OUT}=250$ mA ⁽⁷⁾		37	45	
		$V_{BAT}=1.2$ V, $I_{OUT}=250$ mA, $T_A=25^\circ\text{C}$ ⁽⁷⁾		75	100	
R_{PD}	Output Discharge $R_{PULL\ DOWN}$	$V_{BAT}=4.5$ V, $V_{OUT}=\text{OFF}$, $I_{FORCE}=20$ mA, $T_A=25^\circ\text{C}$		65	85	Ω
V_{IH}	Input High Voltage ⁽⁸⁾	$1.8\text{ V} < V_{BAT} \leq 5.5\text{ V}$	1.2			V
		$1.2\text{ V} \leq V_{BAT} \leq 1.8\text{ V}$	1.0			V
V_{IL}	Input Low Voltage ⁽⁸⁾				0.45	V
I_{IN}	Input Leakage Current ⁽⁸⁾	$0\text{ V} \leq V_{BAT} \leq 5.5\text{ V}$			± 1.5	μA
I_{CCQ}	Quiescent Current	$/\text{SR}0=5.5$ V, $\text{DSR}=5.5$ V, $\text{SYS_WAKE}=5.5$ V, $\text{OFF}=\text{GND}$, $I_{OUT}=0$ mA, $V_{BAT}=5.5$ V, Load Switch=ON		5	7	μA
		$/\text{SR}0=3.8$ V, $\text{DSR}=3.8$ V, $\text{SYS_WAKE}=3.8$ V, $\text{OFF}=\text{GND}$, $I_{OUT}=0$ mA, $V_{BAT}=3.8$ V, Load Switch=ON		4	5.5	
I_{CCT}		$/\text{SR}0=1.2$ V or $\text{DSR}=1.2$ V or $\text{OFF}=1.2$ V, $\text{SYS_Wake}=1.2$ V, $V_{BAT}=5.5$ V, Load Switch=ON		7	12	μA
I_{CC}	Dynamic Supply Current	$/\text{SR}0=\text{GND}$, $\text{DSR}=5.5$ V, $V_{BAT}=5.5$ V, Load Switch=ON			60	μA

Notes:

- This parameter is guaranteed by design and characterization; R_{ON} is tested with different voltage and current conditions in production.
- Input pins are $/\text{SR}0$, OFF , DSR , and SYS_WAKE . Input pins should not be floated when V_{BAT} is connected to the power supply.

AC Electrical Characteristics

Unless otherwise noted, $V_{BAT}=1.2$ to 5.5 V and $T_A=-40$ to $+85^\circ\text{C}$; typical values are at $V_{BAT}=4.5$ V and $T_A=25^\circ\text{C}$.

Symbol	Parameter	Conditions	Min.	Typ.	Max.	Unit
Power-On and Reset Timing						
t_{VON}	Turn-On Time for V_{OUT}	$C_L=5$ pF, $R_L=5$ k Ω , DSR=HIGH, Figure 30	1.8	2.3	2.8	s
t_{PHL1}	Timer Delay before Reset	$C_L=5$ pF, $R_L=5$ k Ω , DSR=HIGH, Figure 31	6.0	7.5	9.0	s
t_{REC1}	Reset Timeout Delay of V_{OUT}	$C_L=5$ pF, $R_L=5$ k Ω , Figure 31	320	400	480	ms
Load Switch Turn-On Timing						
t_{DON}	Turn-On Delay ⁽⁹⁾	$V_{BAT}=4.5$ V, $R_L=5$ Ω , $C_L=100$ μF , $T_A=25^\circ\text{C}$, Figure 29		1.7		ms
t_R	V_{OUT} Rise Time ⁽⁹⁾			2.7		ms
t_{ON}	Turn-On Time ⁽⁹⁾ , SYS_WAKE to V_{OUT}			4.4		ms
Load Switch Turn-Off with Delay						
t_{SD}	Delay to Turn Off Load Switch	$V_{BAT}=4.5$ V, $R_L=150$ Ω , $C_L=100$ μF , $T_A=25^\circ\text{C}$, DSR=HIGH, Figure 28	5.8	7.3	8.8	s
t_F	V_{OUT} Fall Time ⁽⁹⁾			10.0		ms
t_{OFF}	Turn-Off ^(10,11)			7.3		s
Load Switch Zero-Second Turn-Off						
t_{SD}	Delay to Turn Off Load Switch	$V_{BAT}=4.5$ V, $R_L=150$ Ω , $C_L=100$ μF , $T_A=25^\circ\text{C}$, DSR=LOW, Figure 28		0.6		ms
t_F	V_{OUT} Fall Time ⁽⁹⁾			10.0		ms
t_{OFF}	Turn-Off ^(10,11)			10.6		ms

Notes:

9. $t_{ON}=t_R + t_{DON}$.
10. $t_{OFF}=t_F + t_{SD}$.
11. Output discharge enabled during off-state.

Zero-Second Factory Test Mode

Unless otherwise noted, $V_{BAT}=1.2$ to 5.5 V and $T_A=-40$ to $+85^\circ\text{C}$; typical values are at $V_{BAT}=4.5$ V and $T_A=25^\circ\text{C}$.

Symbol	Parameter	Conditions	Min.	Typ.	Max.	Unit
t_{VON}	Turn-On Time for V_{OUT}	$C_L=5$ pF, $R_L=5$ k Ω , $V_{OUT}=OFF$, DSR=LOW, Figure 30		4		ms
t_{PHL1}	Timer Delay before Reset	$C_L=5$ pF, $R_L=5$ k Ω , $V_{OUT}=ON$, DSR=LOW, Figure 31		1		ms

Typical Characteristics

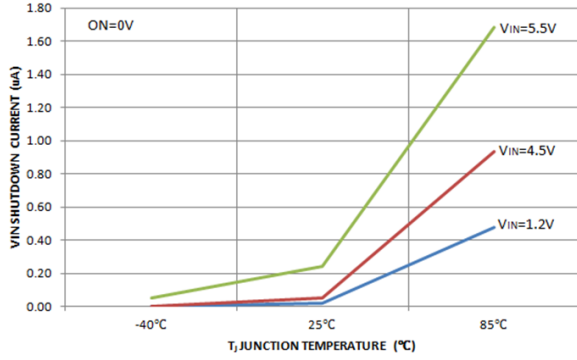

Figure 6. Shutdown Current vs. Temperature

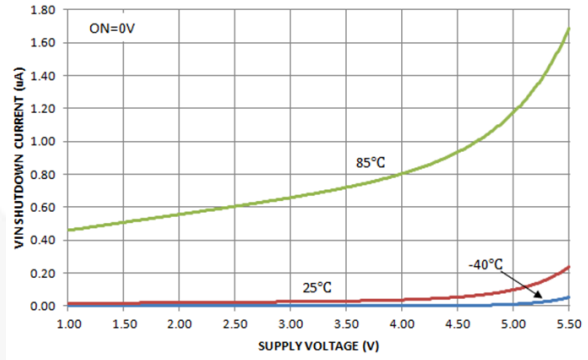

Figure 7. Shutdown Current vs. Supply Voltage

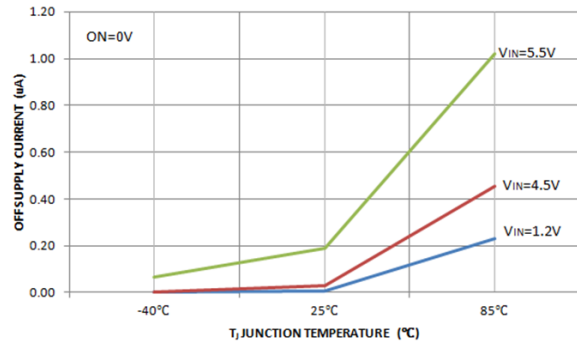

Figure 8. Off Supply Current vs. Temperature ($V_{OUT}=0\text{ V}$)

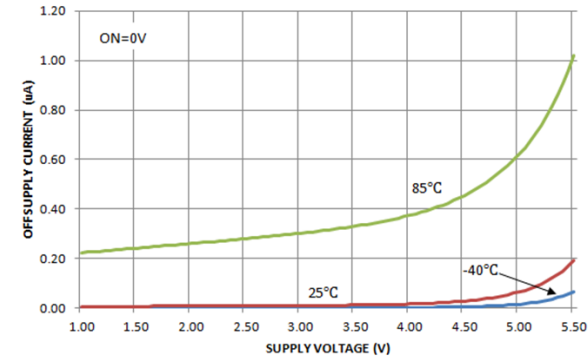

Figure 9. Off Supply Current vs. Supply Voltage ($V_{OUT}=0\text{ V}$)

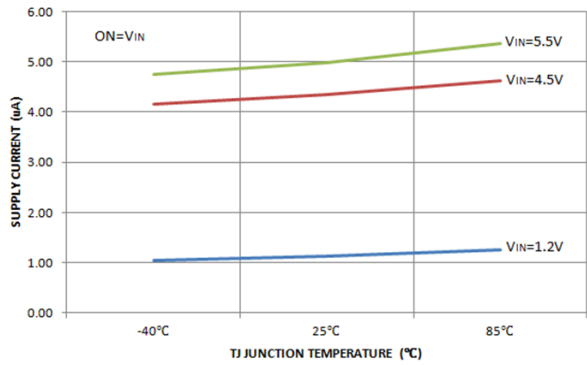

Figure 10. Quiescent Current vs. Temperature

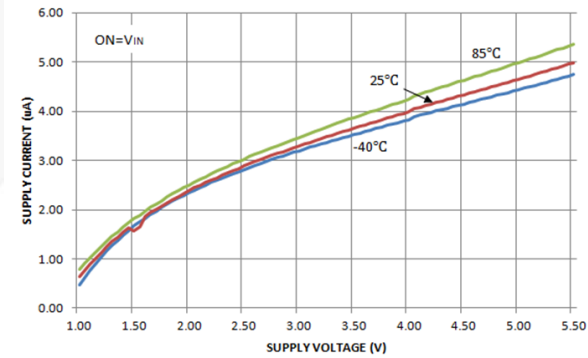

Figure 11. Quiescent Current vs. Supply Voltage

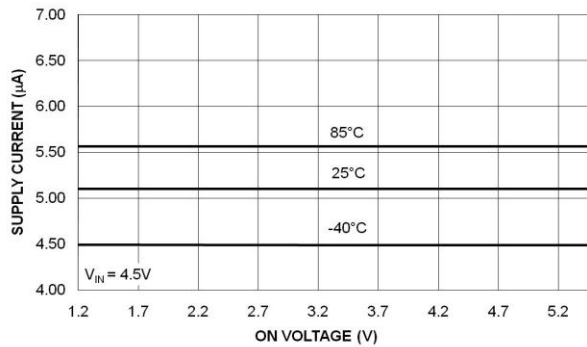

Figure 12. Quiescent Current vs. On Voltage ($V_{BAT}=4.5\text{ V}$)

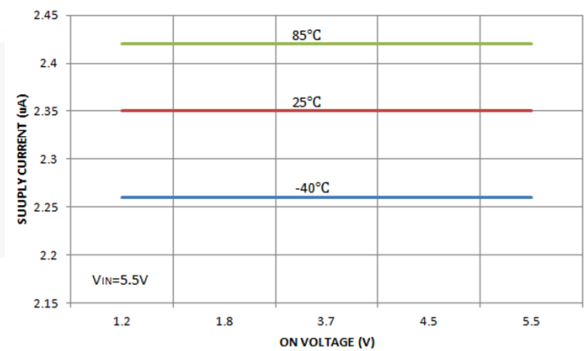

Figure 13. Quiescent Current vs. On Voltage ($V_{BAT}=5.5\text{ V}$)

Typical Characteristics

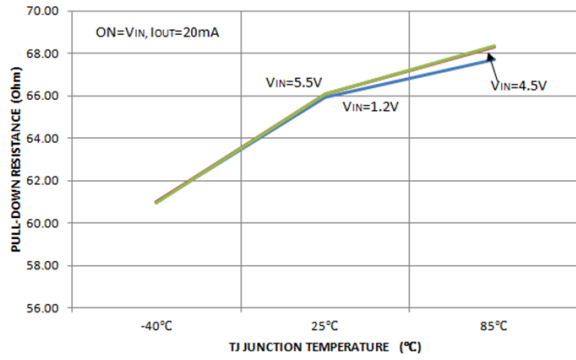

Figure 14. Output Discharge Resistor R_{PD} vs. Temperature

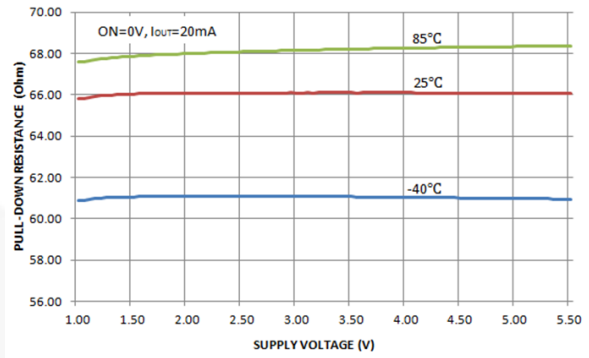

Figure 15. Output Discharge Resistor R_{PD} vs. Supply Voltage

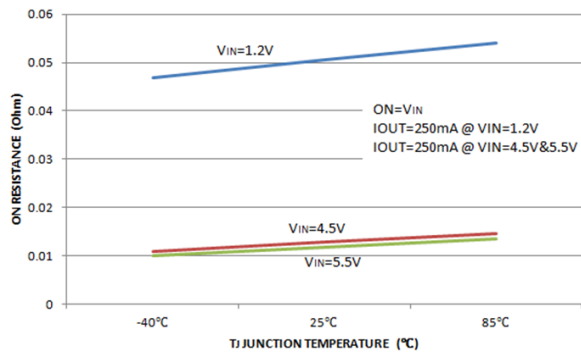

Figure 16. R_{ON} vs. Temperature

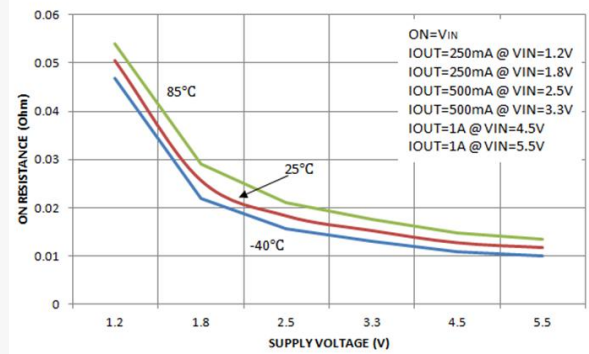

Figure 17. R_{ON} vs. Supply Voltage

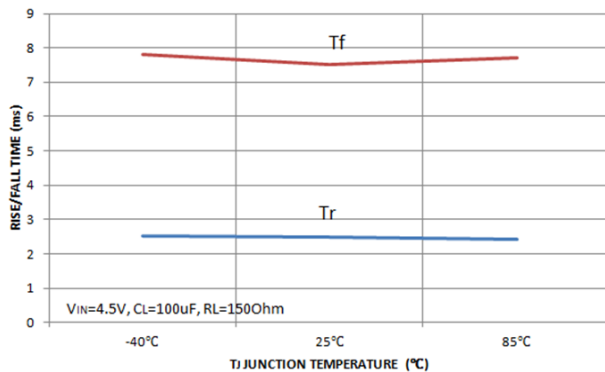

Figure 18. t_R/t_F vs. Temperature

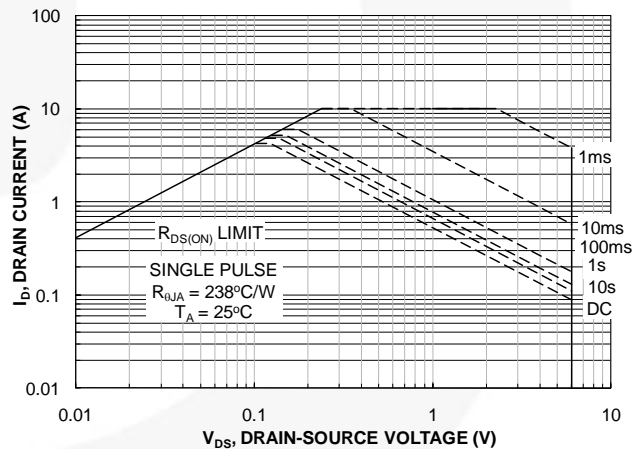

Figure 19. I_{SW} vs. $(V_{BAT}-V_{OUT})$ — SOA

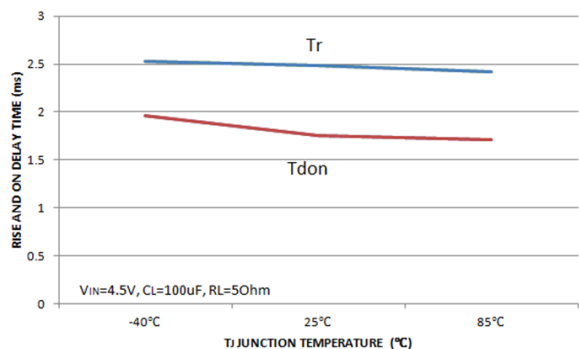

Figure 20. t_R/t_{DON} vs. Temperature

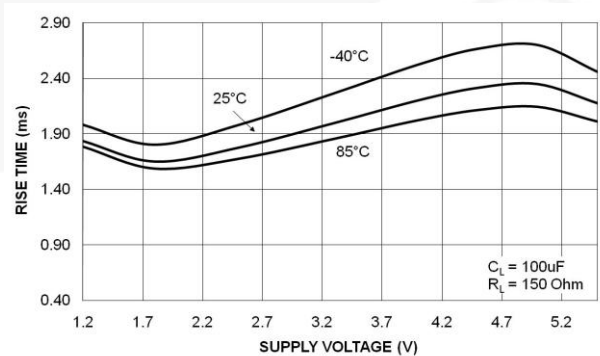

Figure 21. t_R vs. Supply Voltage

Typical Characteristics

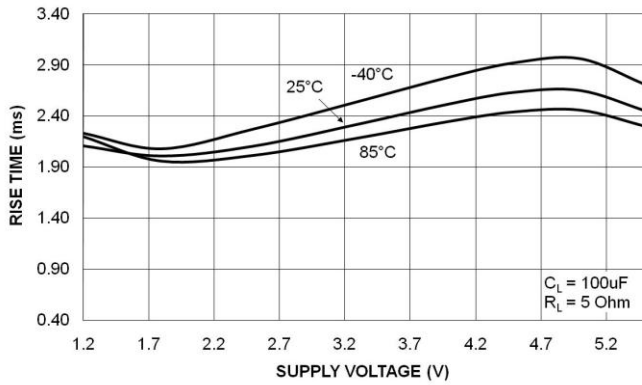

Figure 22. t_R vs. Supply Voltage

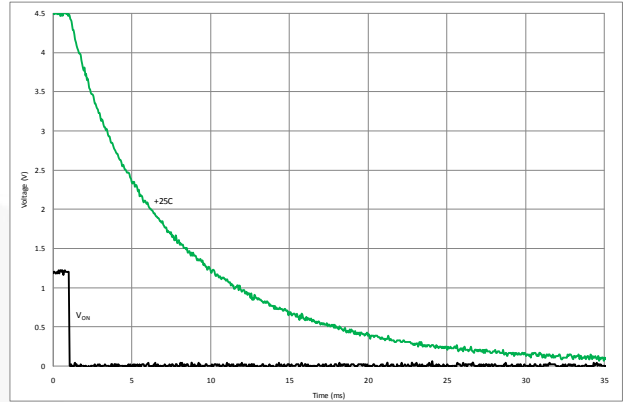

Figure 23. Turn-Off Response ($V_{BAT}=4.5$ V, $C_{IN}=10$ μ F, $C_L=100$ μ F, without External R_L)

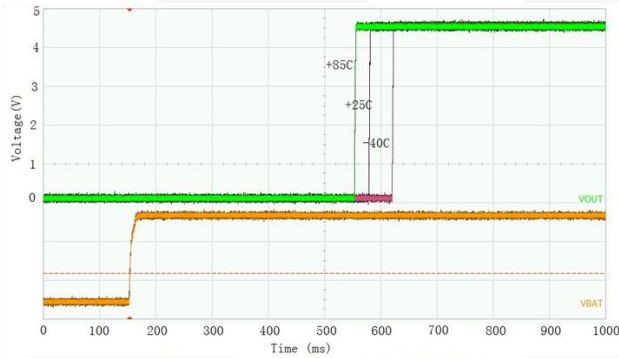

Figure 24. Turn-On Response ($V_{BAT}=4.5$ V, $C_{IN}=10$ μ F, $C_L=1$ μ F, $R_L=50$ Ω)

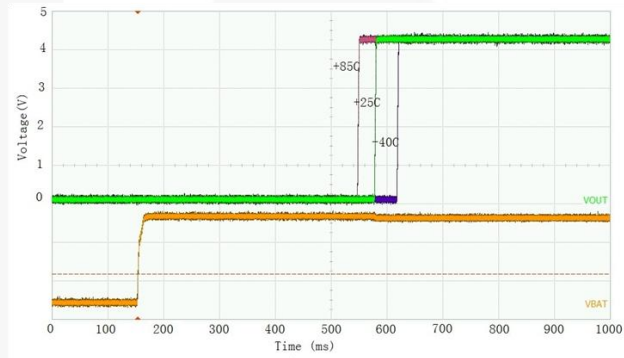

Figure 25. Turn-On Response ($V_{BAT}=4.5$ V, $C_{IN}=10$ μ F, $C_L=100$ μ F, $R_L=5$ Ω)

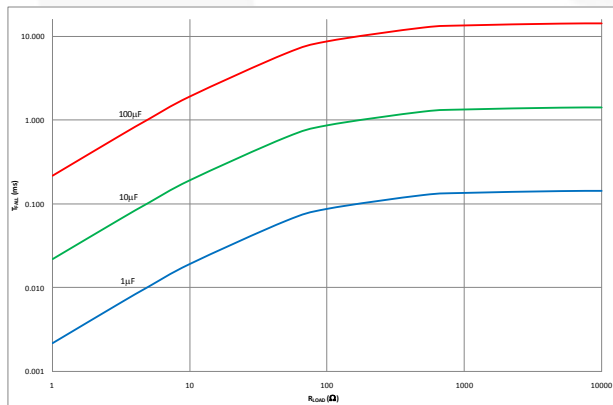

Figure 26. Fall Time as a Function of External Resistive Load ($C_L=1$ μ F, 10 μ F, and 100 μ F)

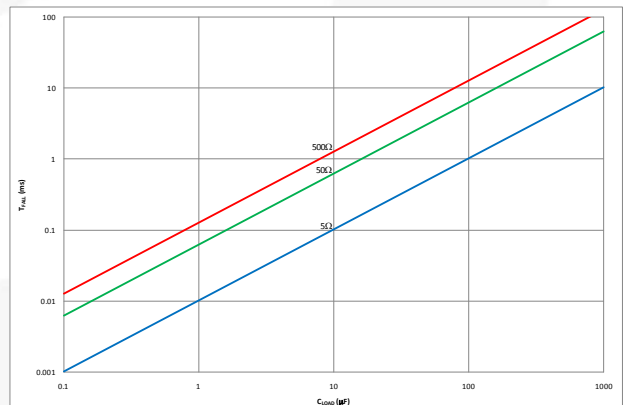

Figure 27. Fall Time as a Function of External Capacitive Load ($R_L=5$ Ω , 50 Ω , and 500 Ω)

Application Information

Reset Timer and Advanced Load Management

The FTL75939 is both a reset IC and an advanced load management device. A typical application is shown in Figure 1.

Disconnect PMIC from Battery (Turn Off)

After holding the DSR pin HIGH, changing the OFF pin from LOW to HIGH (rising edge triggered) and holding it HIGH for at least 1 ms; the FTL75939 triggers an internal counter to allow a factory-customized 7.3 s delay before turning off internal load switch. The delay is intended to allow the PMIC to complete a power-down sequence before safely disconnecting from the power supply. However, the turn-off sequence is terminated if a higher priority input is detected in t_{SD} period (see *Resolving Input Conflicts*).

Alternatively, after holding the DSR pin LOW, changing the OFF pin from LOW to HIGH (rising edge triggered) and holding it HIGH for at least 1 ms; the FTL75939 triggers the zero-second turn-off. Delay t_{SD} is significantly reduced to 0.6 ms to avoid the default delay to turn-off load switch (t_{SD}).

With its stringent shutdown current flow, the FTL75939 significantly reduces the current drain on a battery when the PMIC is turned off. This preserves the battery power for a longer period when a mobile device is in Shutdown Mode.

Power On

There are two methods to turn on the load switch to wake up the PMIC. When a HIGH is inserted to the SYS_WAKE pin or when /SR0 is held LOW for > 2.3 s (see *Figure 30*); the FTL75939 turns on its load switch to allow PMIC to connect to the battery. The reset feature is disabled when V_{OUT} is toggled from OFF to ON. Continuously holding /SR0 LOW does not trigger a reset event.

To enable the reset feature, /SR0 must return to HIGH such that FTL75939 resets its internal counter.

Reset Timer

During normal operation of a mobile device, if a reset operation is needed for mobile equipment, holding the power switch, to which /SR0 is connected and is forced LOW, for at least 7.5 s, causes the FTL75939 to cut off the supply power to PMIC for 400 ms by turning off the load switch. The FTL75939 then automatically turns on the load switch to reconnect the PMIC to battery. This forces PMIC to enter a power-on sequence.

If the power switch is released and /SR0 is returned to HIGH within 7.5 s, the FTL75939 resets its counter and V_{OUT} remains in ON state; there is no change on V_{OUT} and a reset does not occur.

Power-On Reset

When FTL75939 is connected to a battery ($V_{BAT} \geq 1.2$ V), the part enters Power-On Reset (POR) Mode. All internal registers are reset and V_{OUT} is ON at the end of POR sequence (see 0).

Zero-Second Factory Test Mode





FTL75939 includes a Zero-Second Factory Test Mode to shorten the turn-on time for V_{OUT} (t_{VON}) and timer delay before reset (t_{PHL1}) for factory testing.

When V_{OUT} is OFF, the default turn-on time (t_{VON}) is 2.3 s. If the DSR pin is LOW prior to /SR0 going LOW, the FTL75939 bypasses the 2.3 s delay and V_{OUT} changes from OFF to ON immediately.

Similarly, default reset delay (t_{PHL1}) is 7.5 s. If V_{OUT} is ON and the DSR pin is LOW prior to /SR0 going LOW, the FTL75939 enters Zero-Second Factory Test Mode and bypasses the default reset delay of 7.5 s; V_{OUT} is pulled from ON to OFF immediately. The reset pulse (t_{REC1}) remains at 400 ms in Zero-Second Factory Test Mode.

DSR should never be left floating during normal operation.

Table 1. V_{OUT} and Input Conditions

Function	Initial Conditions (t=0 Second)				Associated Delay	V_{OUT}	
	/SR0	SYS_WAKE	OFF	DSR		Before	After
Power-On	LOW	X ⁽¹²⁾	X	LOW	$t_{VON} < 4$ ms	OFF	ON
	LOW	X	X	HIGH	$t_{VON}=2.3$ s	OFF	ON
	HIGH	HIGH	X	X	$t_{ON}=4.4$ ms	OFF	ON
Reset Function	LOW	X	X	LOW	$t_{PHL1} < 1$ ms $t_{REC1}=400$ ms	ON	 ⁽¹²⁾
	LOW	X	X	HIGH	$t_{PHL1}=7.5$ s ⁽¹³⁾ $t_{REC1}=400$ ms	ON	
Turn Off	HIGH	LOW	 ⁽¹²⁾	LOW	$t_{SD} < 1$ ms	ON	OFF
	HIGH	LOW		HIGH	$t_{SD}=7.3$ s	ON	OFF

Notes:

12. X=Don't Care,  = Rising Edge,  =HIGH to LOW to HIGH.

13. Reset delay (t_{PHL1}) is adjustable (see *Table 4*).

Table 2. Pin Condition after POR

Pin Name	/SR0	DSR	SYS_WAKE	OFF	VOUT
Default State (after POR)	1	1	0	0	ON

Note:

14. 1=Input Logic HIGH, 0=Input Logic LOW, ON=load switch is ON state.

Timing Diagrams

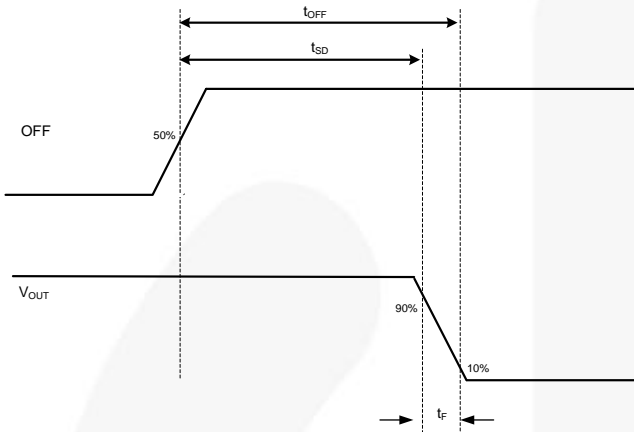

Figure 28. Timing Diagram (OFF vs. V_{OUT})

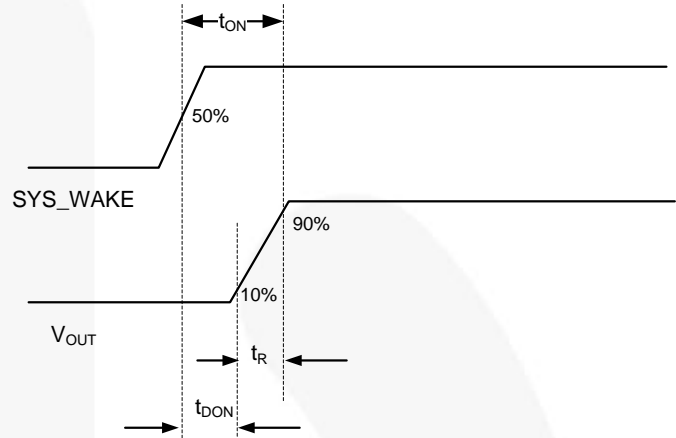

Figure 29. Timing Diagram (SYS_WAKE vs. V_{OUT})

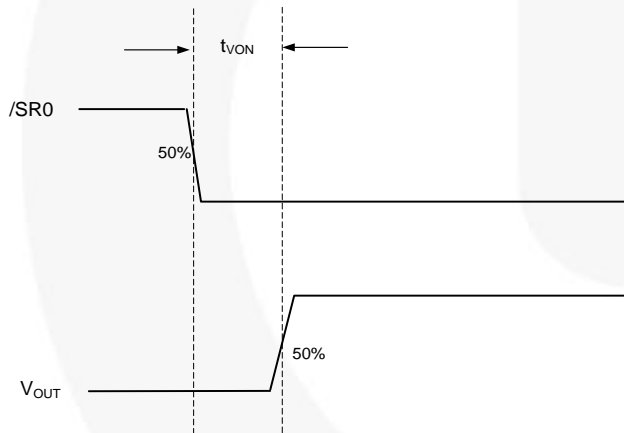

Figure 30. Power On with /SR0

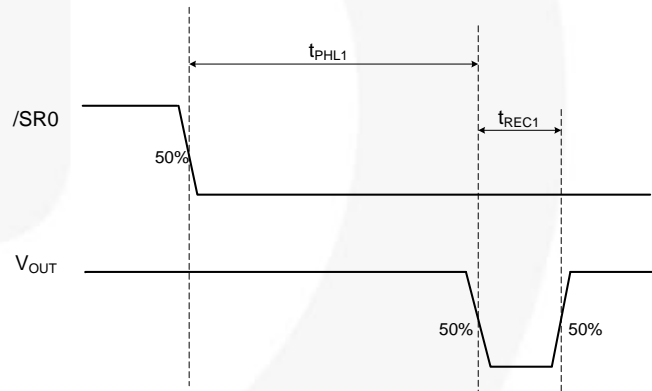

Figure 31. Reset Timing

Resolving Input Conflicts

The FTL75939 allows multiple simultaneous inputs and can resolve conflicts based on priority level (see Table 3). When two input pins are triggered at the same time, only the higher priority input is served and the lower priority input is ignored. The lower-priority signal must be repeated to be serviced.

Table 3. Input Priority

Input	Priority (1=Highest)
/SR0	1
SYS_WAKE	2
OFF	3

Special Note on OFF Pin

In the t_{SD} period (DSR=HIGH only, see Figure 28); if /SR0 or SYS_WAKE is triggered when $0 < t < t_{SD}$, the FTL75939 exits the turn-off sequence and V_{OUT} remains in ON state. The higher priority input is served regardless of the condition of OFF pin.

To re-initiate the turn-off sequence, the OFF pins must return to LOW, then toggle from LOW to HIGH again. The same input priority applies (Table 3) if DSR = HIGH.

Special Note on SYS_WAKE Pin

The SYS_WAKE pin is designed and characterized to handle high voltage input: at least 20 V. Therefore, in application, a current-limiting resistor (i.e 100 kΩ) is required between SYS_WAKE and the input signal regardless of input voltage.

Adjustable Reset Delay with an External Resistor and DSR

The reset delay is adjustable by connecting a commonly available, low-power, $\pm 5\%$, RoHS-compliant resistor between the DELAY_ADJ pin and the GND pin (see Table 4). To disable the adjustable delay feature, DELAY_ADJ should be tied to V_{BAT} directly.

The reset delay is factory programmed at 7.5 s.

The additional power consumption caused by using an external resistor is negligible. The external resistor is normally disconnected and is enabled for milliseconds when /SR0 is pulled LOW.

This external adjustment feature provides a simple alternate method for controlling delay time for engineering and production at customer's location.

Fairchild can also factory program a wide range of turn-on times for V_{OUT} (t_{VON}), timer delay before reset (t_{PHL1}), reset timeout delay for V_{OUT} (t_{REC1}), and load switch turn-off time (t_{OFF}) to match customer applications. In this case, the external resistor (R_{ADJ}) can be eliminated.

For more details, contact an authorized sales representative: <http://www.fairchildsemi.com/cf/#Regional-Sales>.

Table 4. Delay Adjustment vs. External Resistor

External Resistor R_{ADJ} (k Ω)	Delay Multiplier	Adjusted Reset Delay t_{PHL1_ADJ} , (Seconds) $\pm 20\%$
Tie to GND (No Resistor)	$0.50 \times t_{PHL1}$	3.8
3.9	$0.75 \times t_{PHL1}$	5.6
10	$1.25 \times t_{PHL1}$	9.4
22	$1.50 \times t_{PHL1}$	11.3
47	$1.75 \times t_{PHL1}$	13.1
120	$2.00 \times t_{PHL1}$	15.0
Tie to V_{BAT} (No Resistor)	$1.00 \times t_{PHL1}$	7.5

IntelliMAX™ Switch Inside the FTL75939

Input Capacitor

The IntelliMAX™ switch inside the reset timer doesn't require an input capacitor. To reduce device inrush current, a 0.1 μF ceramic capacitor, C_{IN} , is recommended close to the V_{BAT} pin. A higher value of C_{IN} can be used to reduce the voltage drop experienced as the switch is turned on into a large capacitive load.

Output Capacitor

While the load switch works without an output capacitor; if parasitic board inductance forces V_{OUT} below GND when switching off, a 0.1 μF capacitor, C_{OUT} , should be placed between V_{OUT} and GND.

Fall Time

Device output fall time can be calculated based on the RC constant of the external components, as follows:

$$t_F = R_L \times C_L \times 2.2 \quad (1)$$

where t_F is 90% to 10% fall time; R_L is output load; and C_L is output capacitor.

The same equation works for a device with a pull-down output resistor. R_L is replaced by a parallel connected pull-down and an external output resistor combination, calculated as:

$$t_F = \frac{R_L \times R_{PD}}{R_L + R_{PD}} \times C_L \times 2.2 \quad (2)$$

where t_F is 90% to 10% fall time; R_L is output load; $R_{PD}=65 \Omega$ is output pull-down resistor; and C_L is the output capacitor.

Resistive Output Load

If resistive output load is missing, the IntelliMAX switch without a pull-down output resistor does not discharge the output voltage. Output voltage drop depends, in that case, mainly on external device leaks.

Application Specifics

At maximum operational voltage ($V_{BAT}=5.5 \text{ V}$), device inrush current might be higher than expected. Spike current should be taken into account if $V_{BAT}>5 \text{ V}$ and the output capacitor is much larger than the input capacitor. Input current I_{BAT} can be calculated as:

$$I_{BAT}(t) \approx \frac{V_{OUT}(t)}{R_{LOAD}} + (C_{LOAD} - C_{IN}) \frac{dV_{OUT}(t)}{dt} \quad (3)$$

where switch and wire resistances are neglected and capacitors are assumed ideal.

Estimating $V_{OUT}(t)=V_{BAT}/10$ and using experimental formula for slew rate ($dV_{OUT}(t)/dt$), spike current can be written as:

$$\max(I_{BAT}) = \frac{V_{BAT}}{10R_{LOAD}} + (C_{LOAD} - C_{IN})(0.05V_{BAT} - 0.255) \quad (4)$$

where supply voltage V_{BAT} is in volts; capacitances are in micro farads; and resistance is in ohms.

Example: If $V_{BAT}=5.5 \text{ V}$, $C_{LOAD}=100 \mu\text{F}$, $C_{IN}=10 \mu\text{F}$, and $R_{LOAD}=50 \Omega$; calculate the spike current by:

$$\max(I_{BAT}) = \frac{5.5}{10 \times 50} + (100 - 10)(0.05 \times 5.5 - 0.255) \text{ A} = 1.8 \text{ A}$$

Maximum spike current is 1.8 A, while average ramp-up current is:

$$I_{BAT}(t) \approx \frac{V_{OUT}(t)}{R_{LOAD}} + (C_{LOAD} - C_{IN}) \frac{dV_{BAT}(t)}{dt} \\ \approx 2.75 / 50 + 100 \times 0.0022 = 0.275 \text{ A}$$

Output Discharge

The device contains a $R_{PD}=65 \Omega$ on-chip pull-down resistor for quick output discharge. The resistor is activated when the switch is turned off.

Recommended Layout

For best thermal performance and minimal inductance and parasitic effects, keeping the input and output traces short and capacitors as close to the device as possible is recommended. Additional recommended layout considerations include:

- A1, A2, and A3 are interconnected at PCB, as close to the landing pad as possible.
- B1, B2, and B3 are interconnected at PCB, as close to the landing pad as possible.
- C1 (GND) is connected to GND plane of PCB.
- Reserve a pad for capacitor connection (C1) between V_{BAT} and GND, if no input capacitor is planned.
- Reserve a pad for capacitor connection (C2) between V_{OUT} and GND, if no output capacitor is planned.
- Use a dedicated V_{OUT} or V_{BAT} plane to improve thermal dissipation.

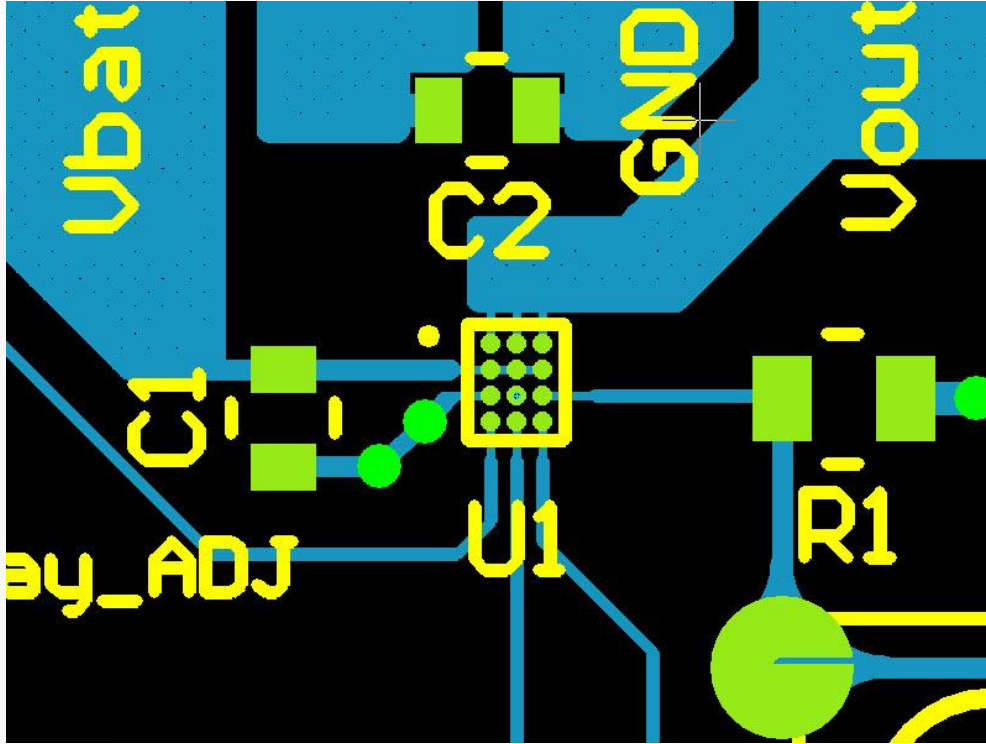

Figure 32. Sample Layout

Physical Dimensions

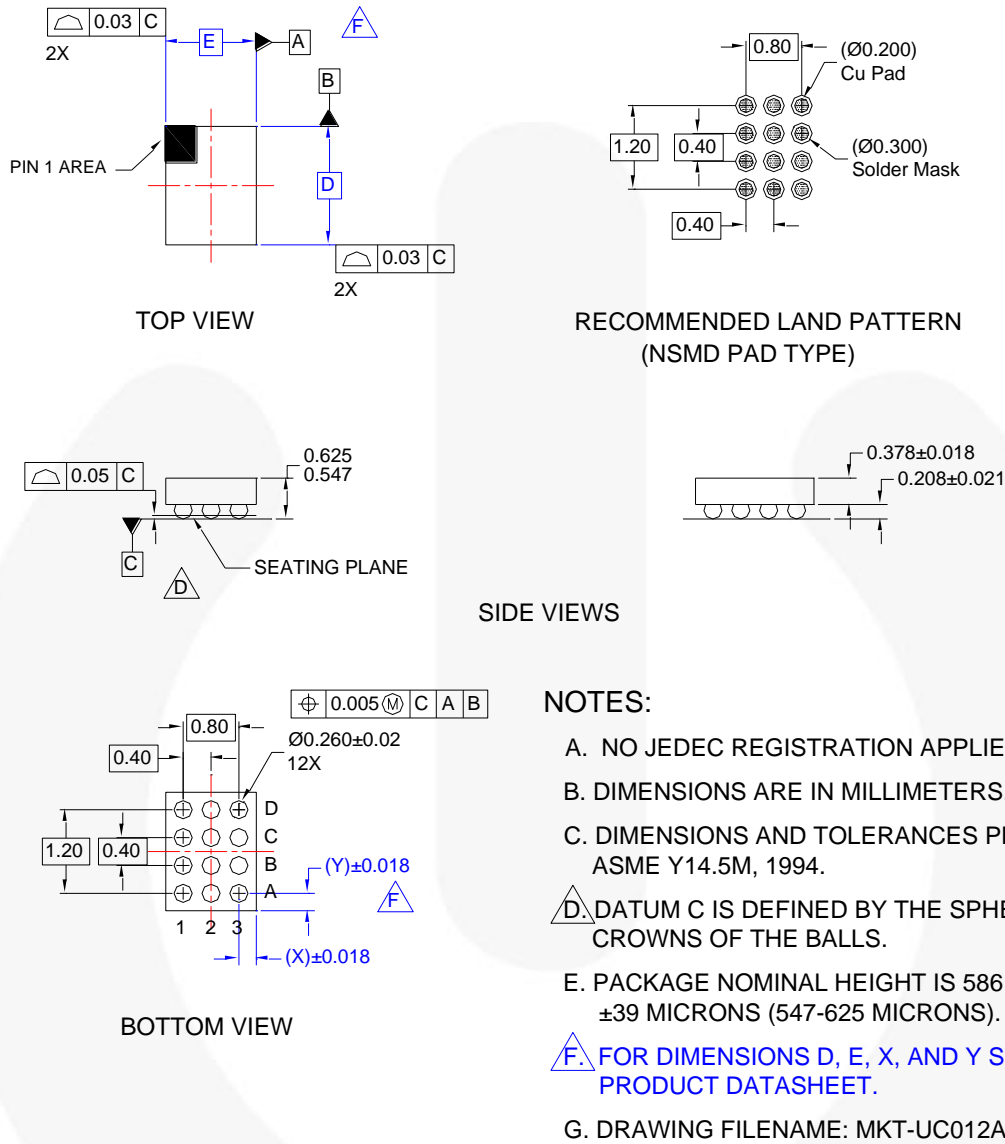

Figure 33. 12-Ball, Wafer-Level Chip-Scale Packaging (WLCSP) 3x4 Array, 0.4 mm Pitch, 250 μ m Ball

D	E	X	Y
1.615 ± 0.030	1.310 ± 0.030	0.255	0.208

Package drawings are provided as a service to customers considering Fairchild components. Drawings may change in any manner without notice. Please note the revision and/or date on the drawing and contact a Fairchild Semiconductor representative to verify or obtain the most recent revision. Package specifications do not expand the terms of Fairchild's worldwide terms and conditions, specifically the warranty therein, which covers Fairchild products.

Always visit Fairchild Semiconductor's online packaging area for the most recent package drawings:
<http://www.fairchildsemi.com/dwg/UC/UC012AC.pdf>.

For current packing container specifications, visit Fairchild Semiconductor's online packaging area:
http://www.fairchildsemi.com/packing_dwg/PKG-UC012AC.pdf.



TRADEMARKS

The following includes registered and unregistered trademarks and service marks, owned by Fairchild Semiconductor and/or its global subsidiaries, and is not intended to be an exhaustive list of all such trademarks.

AccuPower™
 AX-CAP®*
 BitSiC™
 Build it Now™
 CorePLUS™
 CorePOWER™
 CROSSVOLT™
 CTL™
 Current Transfer Logic™
 DEUXPEED®
 Dual Cool™
 EcoSPARK®
 EfficientMax™
 ESBC™

 Fairchild®
 Fairchild Semiconductor®
 FACT Quiet Series™
 FACT®
 FAST®
 FastvCore™
 FETBench™
 FPS™

F-PFS™
 FRFET®
 Global Power Resource™
 GreenBridge™
 Green FPS™
 Green FPS™ e-Series™
 Gmax™
 GTO™
 IntelliMAX™
 ISOPLANAR™
 Making Small Speakers Sound Louder and Better™
 MegaBuck™
 MICROCOUPLER™
 MicroFET™
 MicroPak™
 MicroPak2™
 MillerDrive™
 MotionMax™
 mWSaver®
 OptoHit™
 OPTOLOGIC®
 OPTOPLANAR®

 PowerTrench®
 PowerXS™
 Programmable Active Droop™
 QFET®
 QS™
 Quiet Series™
 RapidConfigure™

 Saving our world, 1mW/W/kW at a time™
 SignalWise™
 SmartMax™
 SMART START™
 Solutions for Your Success™
 SPM®
 STEALTH™
 SuperFET®
 SuperSOT™-3
 SuperSOT™-6
 SuperSOT™-8
 SupreMOS®
 SyncFET™
 Sync-Lock™

 SYSTEM GENERAL®
 TinyBoost®
 TinyBuck®
 TinyCalc™
 TinyLogic®
 TINYOPTO™
 TinyPower™
 TinyPWM™
 TinyWire™
 TranSiC™
 TriFault Detect™
 TRUECURRENT®*
 μSerDes™
 SerDes®
 UHC®
 Ultra FRFET™
 UniFET™
 VCX™
 VisualMax™
 VoltagePlus™
 XS™
 仙童™

* Trademarks of System General Corporation, used under license by Fairchild Semiconductor.

DISCLAIMER

FAIRCHILD SEMICONDUCTOR RESERVES THE RIGHT TO MAKE CHANGES WITHOUT FURTHER NOTICE TO ANY PRODUCTS HEREIN TO IMPROVE RELIABILITY, FUNCTION, OR DESIGN. FAIRCHILD DOES NOT ASSUME ANY LIABILITY ARISING OUT OF THE APPLICATION OR USE OF ANY PRODUCT OR CIRCUIT DESCRIBED HEREIN; NEITHER DOES IT CONVEY ANY LICENSE UNDER ITS PATENT RIGHTS, NOR THE RIGHTS OF OTHERS. THESE SPECIFICATIONS DO NOT EXPAND THE TERMS OF FAIRCHILD'S WORLDWIDE TERMS AND CONDITIONS, SPECIFICALLY THE WARRANTY THEREIN, WHICH COVERS THESE PRODUCTS.

LIFE SUPPORT POLICY

FAIRCHILD'S PRODUCTS ARE NOT AUTHORIZED FOR USE AS CRITICAL COMPONENTS IN LIFE SUPPORT DEVICES OR SYSTEMS WITHOUT THE EXPRESS WRITTEN APPROVAL OF FAIRCHILD SEMICONDUCTOR CORPORATION.

As used herein:

1. Life support devices or systems are devices or systems which, (a) are intended for surgical implant into the body or (b) support or sustain life, and (c) whose failure to perform when properly used in accordance with instructions for use provided in the labeling, can be reasonably expected to result in a significant injury of the user.
2. A critical component in any component of a life support, device, or system whose failure to perform can be reasonably expected to cause the failure of the life support device or system, or to affect its safety or effectiveness.

ANTI-COUNTERFEITING POLICY

Fairchild Semiconductor Corporation's Anti-Counterfeiting Policy. Fairchild's Anti-Counterfeiting Policy is also stated on our external website, www.fairchildsemi.com, under Sales Support.

Counterfeiting of semiconductor parts is a growing problem in the industry. All manufacturers of semiconductor products are experiencing counterfeiting of their parts. Customers who inadvertently purchase counterfeit parts experience many problems such as loss of brand reputation, substandard performance, failed applications, and increased cost of production and manufacturing delays. Fairchild is taking strong measures to protect ourselves and our customers from the proliferation of counterfeit parts. Fairchild strongly encourages customers to purchase Fairchild parts either directly from Fairchild or from Authorized Fairchild Distributors who are listed by country on our web page cited above. Products customers buy either from Fairchild directly or from Authorized Fairchild Distributors are genuine parts, have full traceability, meet Fairchild's quality standards for handling and storage and provide access to Fairchild's full range of up-to-date technical and product information. Fairchild and our Authorized Distributors will stand behind all warranties and will appropriately address any warranty issues that may arise. Fairchild will not provide any warranty coverage or other assistance for parts bought from Unauthorized Sources. Fairchild is committed to combat this global problem and encourage our customers to do their part in stopping this practice by buying direct or from authorized distributors.

PRODUCT STATUS DEFINITIONS

Definition of Terms

Datasheet Identification	Product Status	Definition
Advance Information	Formative / In Design	Datasheet contains the design specifications for product development. Specifications may change in any manner without notice.
Preliminary	First Production	Datasheet contains preliminary data; supplementary data will be published at a later date. Fairchild Semiconductor reserves the right to make changes at any time without notice to improve design.
No Identification Needed	Full Production	Datasheet contains final specifications. Fairchild Semiconductor reserves the right to make changes at any time without notice to improve the design.
Obsolete	Not In Production	Datasheet contains specifications on a product that is discontinued by Fairchild Semiconductor. The datasheet is for reference information only.

Rev. 168

Mouser Electronics

Authorized Distributor

Click to View Pricing, Inventory, Delivery & Lifecycle Information:

[Fairchild Semiconductor:](#)

[FTL75939UCX](#)