



Is Now Part of



**ON Semiconductor®**

To learn more about ON Semiconductor, please visit our website at  
[www.onsemi.com](http://www.onsemi.com)

ON Semiconductor and the ON Semiconductor logo are trademarks of Semiconductor Components Industries, LLC dba ON Semiconductor or its subsidiaries in the United States and/or other countries. ON Semiconductor owns the rights to a number of patents, trademarks, copyrights, trade secrets, and other intellectual property. A listing of ON Semiconductor's product/patent coverage may be accessed at [www.onsemi.com/site/pdf/Patent-Marking.pdf](http://www.onsemi.com/site/pdf/Patent-Marking.pdf). ON Semiconductor reserves the right to make changes without further notice to any products herein. ON Semiconductor makes no warranty, representation or guarantee regarding the suitability of its products for any particular purpose, nor does ON Semiconductor assume any liability arising out of the application or use of any product or circuit, and specifically disclaims any and all liability, including without limitation special, consequential or incidental damages. Buyer is responsible for its products and applications using ON Semiconductor products, including compliance with all laws, regulations and safety requirements or standards, regardless of any support or applications information provided by ON Semiconductor. "Typical" parameters which may be provided in ON Semiconductor data sheets and/or specifications can and do vary in different applications and actual performance may vary over time. All operating parameters, including "Typicals" must be validated for each customer application by customer's technical experts. ON Semiconductor does not convey any license under its patent rights nor the rights of others. ON Semiconductor products are not designed, intended, or authorized for use as a critical component in life support systems or any FDA Class 3 medical devices or medical devices with a same or similar classification in a foreign jurisdiction or any devices intended for implantation in the human body. Should Buyer purchase or use ON Semiconductor products for any such unintended or unauthorized application, Buyer shall indemnify and hold ON Semiconductor and its officers, employees, subsidiaries, affiliates, and distributors harmless against all claims, costs, damages, and expenses, and reasonable attorney fees arising out of, directly or indirectly, any claim of personal injury or death associated with such unintended or unauthorized use, even if such claim alleges that ON Semiconductor was negligent regarding the design or manufacture of the part. ON Semiconductor is an Equal Opportunity/Affirmative Action Employer. This literature is subject to all applicable copyright laws and is not for resale in any manner.

**1200 V NPT IGBT**

HGTG18N120BND is based on Non- Punch Through (NPT) IGBT designs. The IGBT is ideal for many high voltage switching applications operating at moderate frequencies where low conduction losses are essential, such as: UPS, solar inverter, motor control and power supplies.

Formerly Developmental Type TA49304.

**Ordering Information**

PART NUMBER	PACKAGE	BRAND
HGTG18N120BND	TO-247	18N120BND

NOTE: When ordering, use the entire part number.

**Symbol**

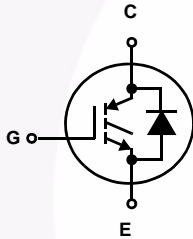

**Features**

- 26 A, 1200 V,  $T_C = 110^\circ\text{C}$
- Low Saturation Voltage:  $V_{CE(sat)} = 2.45\text{ V @ } I_C = 18\text{ A}$
- Typical Fall Time . . . . . 140ns at  $T_J = 150^\circ\text{C}$
- Short Circuit Rating
- Low Conduction Loss

**Packaging**

JEDEC STYLE TO-247

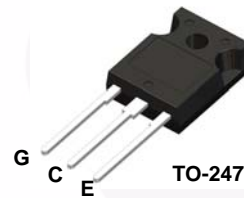

# HGTG18N120BND

## Absolute Maximum Ratings $T_C = 25^\circ\text{C}$ , Unless Otherwise Specified

	Ratings	UNIT
Collector to Emitter Voltage . . . . .	$BV_{CES}$	1200 V
Collector Current Continuous		
At $T_C = 25^\circ\text{C}$ . . . . .	$I_{C25}$	54 A
At $T_C = 110^\circ\text{C}$ . . . . .	$I_{C110}$	26 A
Collector Current Pulsed (Note 1) . . . . .	$I_{CM}$	160 A
Gate to Emitter Voltage Continuous . . . . .	$V_{GES}$	$\pm 20$ V
Gate to Emitter Voltage Pulsed . . . . .	$V_{GEM}$	$\pm 30$ V
Switching Safe Operating Area at $T_J = 150^\circ\text{C}$ (Figure 2) . . . . .	SSOA	100A at 1200V
Power Dissipation Total at $T_C = 25^\circ\text{C}$ . . . . .	$P_D$	390 W
Power Dissipation Derating $T_C > 25^\circ\text{C}$ . . . . .		3.12 W/ $^\circ\text{C}$
Operating and Storage Junction Temperature Range . . . . .	$T_J, T_{STG}$	-55 to 150 $^\circ\text{C}$
Maximum Lead Temperature for Soldering . . . . .	$T_L$	260 $^\circ\text{C}$
Short Circuit Withstand Time (Note 2) at $V_{GE} = 15$ V . . . . .	$t_{SC}$	8 $\mu\text{s}$
Short Circuit Withstand Time (Note 2) at $V_{GE} = 12$ V . . . . .	$t_{SC}$	15 $\mu\text{s}$

CAUTION: Stresses above those listed in "Absolute Maximum Ratings" may cause permanent damage to the device. This is a stress only rating and operation of the device at these or any other conditions above those indicated in the operational sections of this specification is not implied.

### NOTES:

1. Pulse width limited by maximum junction temperature.
2.  $V_{CE(PK)} = 960$  V,  $T_J = 125^\circ\text{C}$ ,  $R_G = 3 \Omega$ .

## Electrical Specifications $T_C = 25^\circ\text{C}$ , Unless Otherwise Specified

PARAMETER	SYMBOL	TEST CONDITIONS	MIN	TYP	MAX	UNIT	
Collector to Emitter Breakdown Voltage	$BV_{CES}$	$I_C = 250 \mu\text{A}$ , $V_{GE} = 0$ V	1200	-	-	V	
Emitter to Collector Breakdown Voltage	$BV_{ECS}$	$I_C = 10$ mA, $V_{GE} = 0$ V	15	-	-	V	
Collector to Emitter Leakage Current	$I_{CES}$	$V_{CE} = 1200$ V	$T_C = 25^\circ\text{C}$	-	-	250	$\mu\text{A}$
			$T_C = 125^\circ\text{C}$	-	300	-	$\mu\text{A}$
			$T_C = 150^\circ\text{C}$	-	-	4	mA
Collector to Emitter Saturation Voltage	$V_{CE(SAT)}$	$I_C = 18$ A, $V_{GE} = 15$ V	$T_C = 25^\circ\text{C}$	-	2.45	2.7	V
			$T_C = 150^\circ\text{C}$	-	3.8	4.2	V
Gate to Emitter Threshold Voltage	$V_{GE(TH)}$	$I_C = 150 \mu\text{A}$ , $V_{CE} = V_{GE}$	6.0	7.0	-	V	
Gate to Emitter Leakage Current	$I_{GES}$	$V_{GE} = \pm 20$ V	-	-	$\pm 250$	nA	
Switching SOA	SSOA	$T_J = 150^\circ\text{C}$ , $R_G = 3 \Omega$ , $V_{GE} = 15$ V, $L = 200 \mu\text{H}$ , $V_{CE(PK)} = 1200$ V	100	-	-	A	
Gate to Emitter Plateau Voltage	$V_{GEP}$	$I_C = 18$ A, $V_{CE} = 600$ V	-	10.5	-	V	
On-State Gate Charge	$Q_{G(ON)}$	$I_C = 18$ A, $V_{CE} = 600$ V	$V_{GE} = 15$ V	-	165	200	nC
			$V_{GE} = 20$ V	-	220	250	nC
Current Turn-On Delay Time	$t_{d(ON)I}$	IGBT and Diode at $T_J = 25^\circ\text{C}$ $I_{CE} = 18$ A $V_{CE} = 960$ V $V_{GE} = 15$ V $R_G = 3 \Omega$ $L = 1$ mH Test Circuit (Figure 20)	-	23	28	ns	
Current Rise Time	$t_{rI}$		-	17	22	ns	
Current Turn-Off Delay Time	$t_{d(OFF)I}$		-	170	200	ns	
Current Fall Time	$t_{fI}$		-	90	140	ns	
Turn-On Energy	$E_{ON}$		-	1.9	2.4	mJ	
Turn-Off Energy (Note 3)	$E_{OFF}$		-	1.8	2.2	mJ	

# HGTG18N120BND

## Electrical Specifications $T_C = 25^\circ\text{C}$ , Unless Otherwise Specified (Continued)

PARAMETER	SYMBOL	TEST CONDITIONS	MIN	TYP	MAX	UNIT
Current Turn-On Delay Time	$t_{d(ON)}$	IGBT and Diode at $T_J = 150^\circ\text{C}$ $I_{CE} = 18\text{ A}$ $V_{CE} = 960\text{ V}$ $V_{GE} = 15\text{ V}$ $R_G = 3\ \Omega$ $L = 1\text{ mH}$ Test Circuit (Figure 20)	-	21	26	ns
Current Rise Time	$t_{rl}$		-	17	22	ns
Current Turn-Off Delay Time	$t_{d(OFF)}$		-	205	240	ns
Current Fall Time	$t_{fl}$		-	140	200	ns
Turn-On Energy	$E_{ON}$		-	3.7	4.9	mJ
Turn-Off Energy (Note 3)	$E_{OFF}$		-	2.6	3.1	mJ
Diode Forward Voltage	$V_{EC}$		$I_{EC} = 18\text{ A}$	-	2.6	3.2
Diode Reverse Recovery Time	$t_{rr}$	$I_{EC} = 18\text{ A}, dI_{EC}/dt = 200\text{ A}/\mu\text{s}$	-	60	75	ns
		$I_{EC} = 2\text{ A}, dI_{EC}/dt = 200\text{ A}/\mu\text{s}$	-	44	55	ns
Thermal Resistance Junction To Case	$R_{\theta JC}$	IGBT	-	-	0.32	$^\circ\text{C}/\text{W}$
		Diode	-	-	0.75	$^\circ\text{C}/\text{W}$

NOTE:

- Turn-Off Energy Loss ( $E_{OFF}$ ) is defined as the integral of the instantaneous power loss starting at the trailing edge of the input pulse and ending at the point where the collector current equals zero ( $I_{CE} = 0\text{ A}$ ). All devices were tested per JEDEC Standard No. 24-1 Method for Measurement of Power Device Turn-Off Switching Loss. This test method produces the true total Turn-Off Energy Loss.

## Typical Performance Curves Unless Otherwise Specified

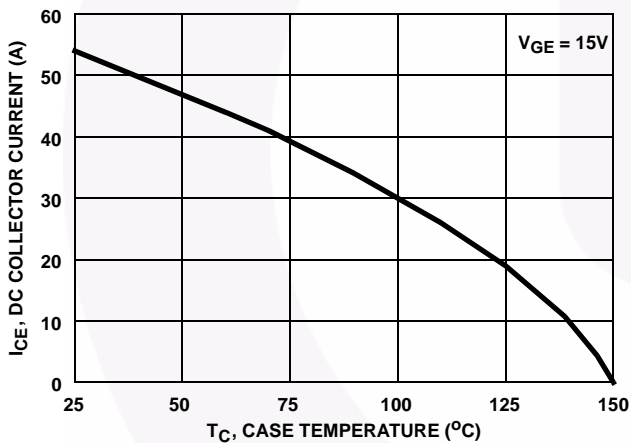

FIGURE 1. DC COLLECTOR CURRENT vs CASE TEMPERATURE

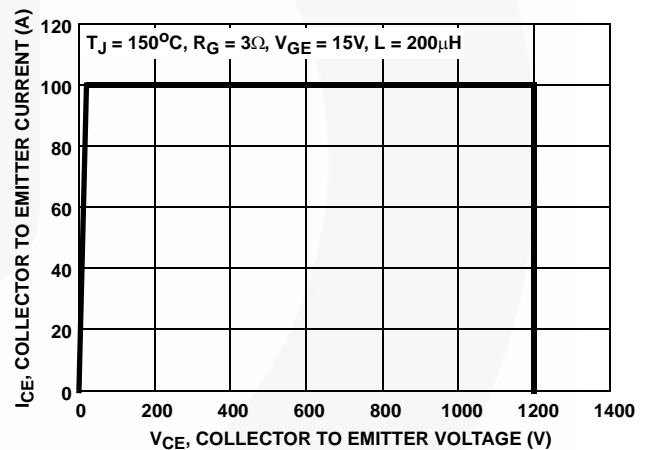

FIGURE 2. MINIMUM SWITCHING SAFE OPERATING AREA

Typical Performance Curves Unless Otherwise Specified (Continued)

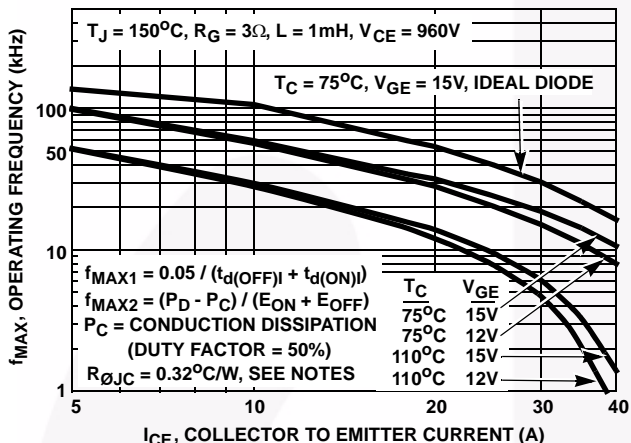

FIGURE 3. OPERATING FREQUENCY vs COLLECTOR TO EMITTER CURRENT

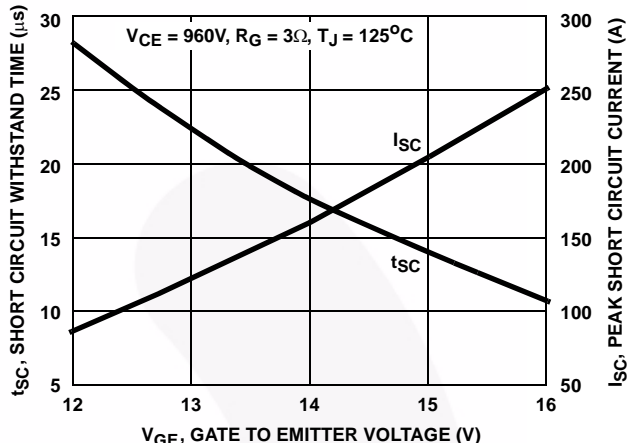

FIGURE 4. SHORT CIRCUIT WITHSTAND TIME

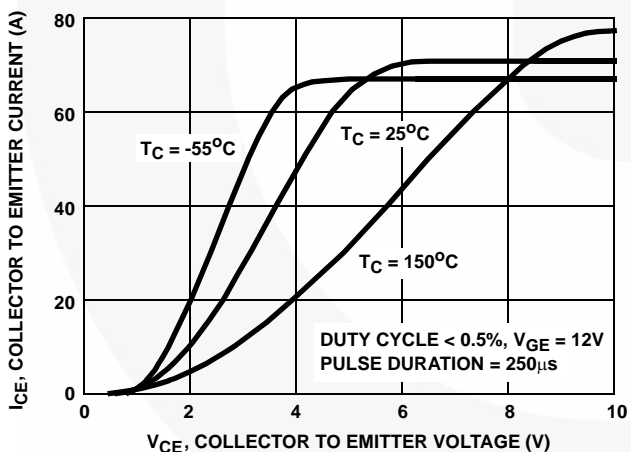

FIGURE 5. COLLECTOR TO EMITTER ON-STATE VOLTAGE

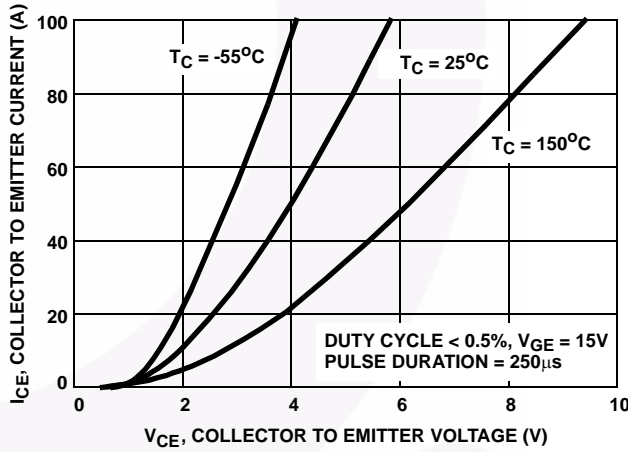

FIGURE 6. COLLECTOR TO EMITTER ON-STATE VOLTAGE

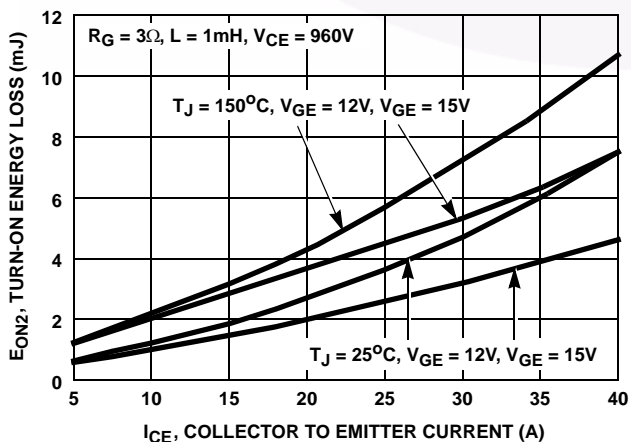

FIGURE 7. TURN-ON ENERGY LOSS vs COLLECTOR TO EMITTER CURRENT

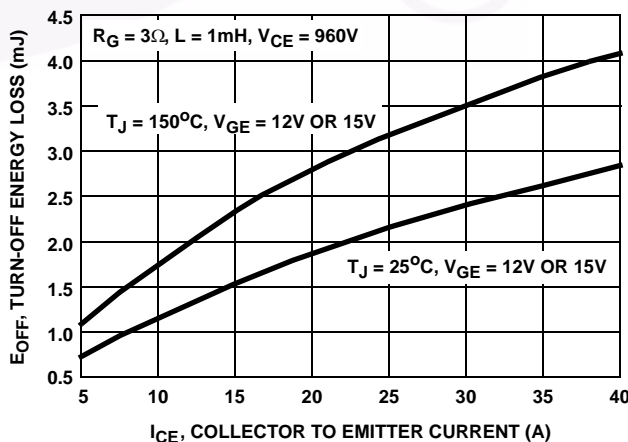

FIGURE 8. TURN-OFF ENERGY LOSS vs COLLECTOR TO EMITTER CURRENT

Typical Performance Curves Unless Otherwise Specified (Continued)

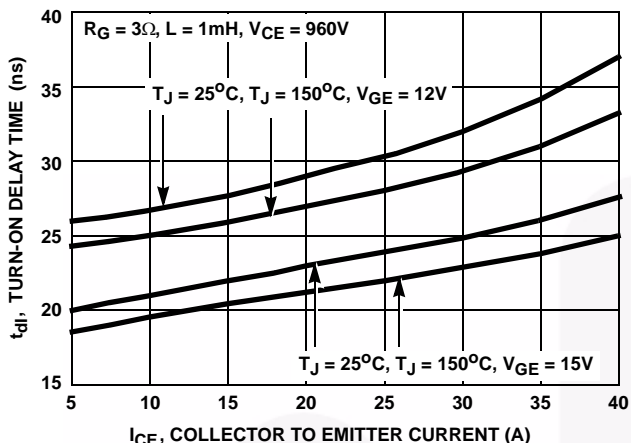

FIGURE 9. TURN-ON DELAY TIME vs COLLECTOR TO EMITTER CURRENT

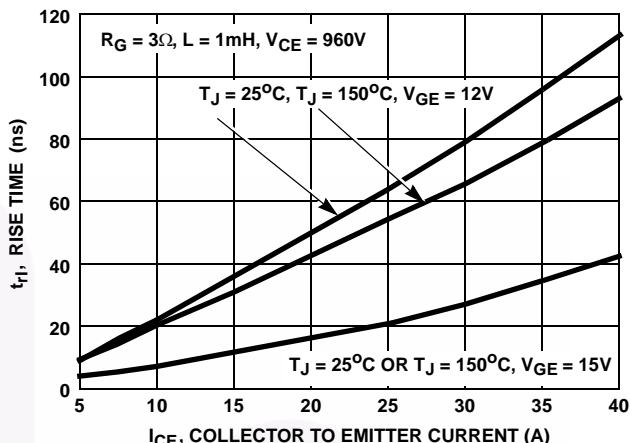

FIGURE 10. TURN-ON RISE TIME vs COLLECTOR TO EMITTER CURRENT

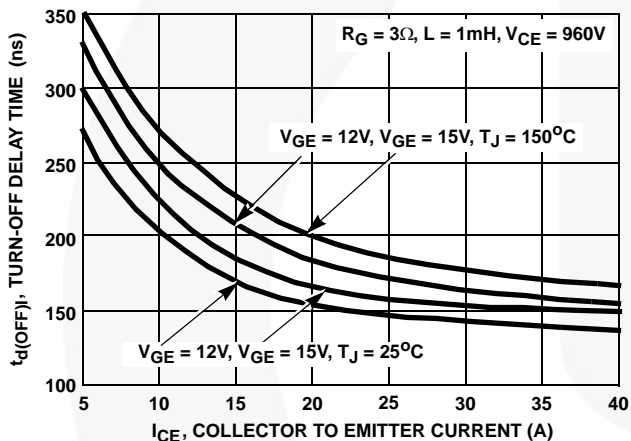

FIGURE 11. TURN-OFF DELAY TIME vs COLLECTOR TO EMITTER CURRENT

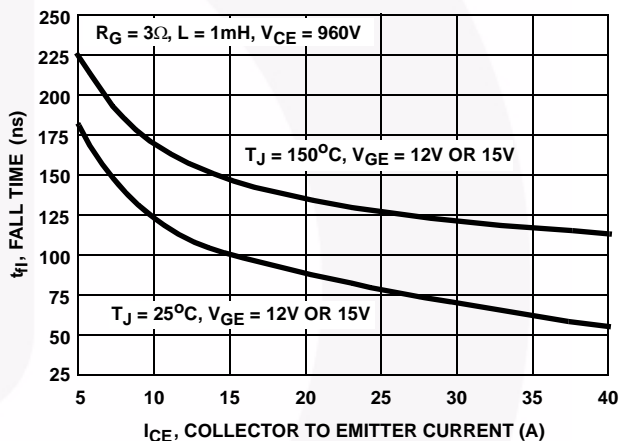

FIGURE 12. FALL TIME vs COLLECTOR TO EMITTER CURRENT

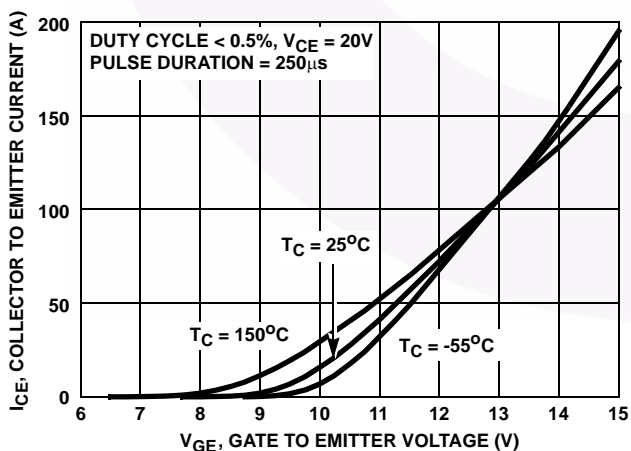

FIGURE 13. TRANSFER CHARACTERISTIC

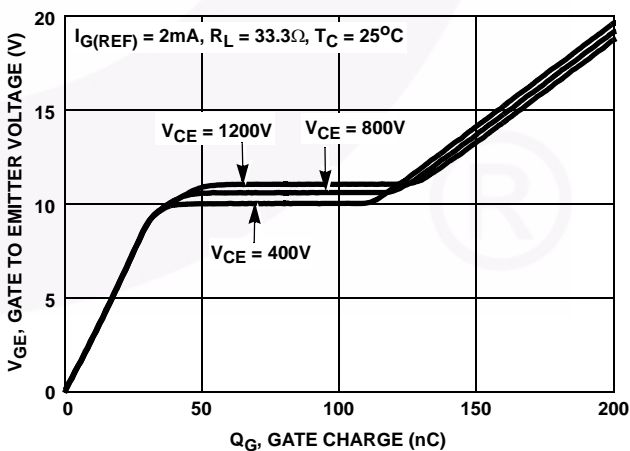

FIGURE 14. GATE CHARGE WAVEFORMS

Typical Performance Curves Unless Otherwise Specified (Continued)

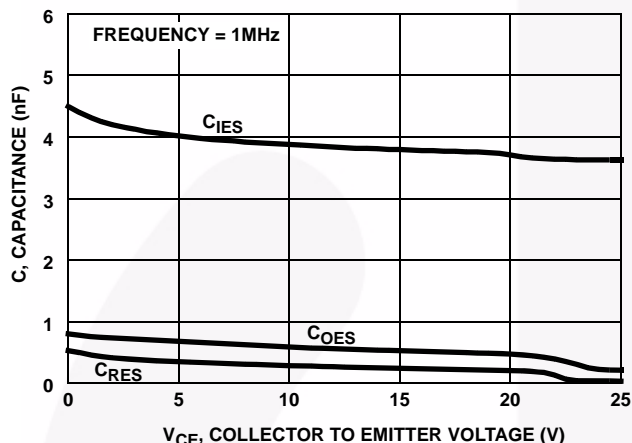

FIGURE 15. CAPACITANCE vs COLLECTOR TO EMITTER VOLTAGE

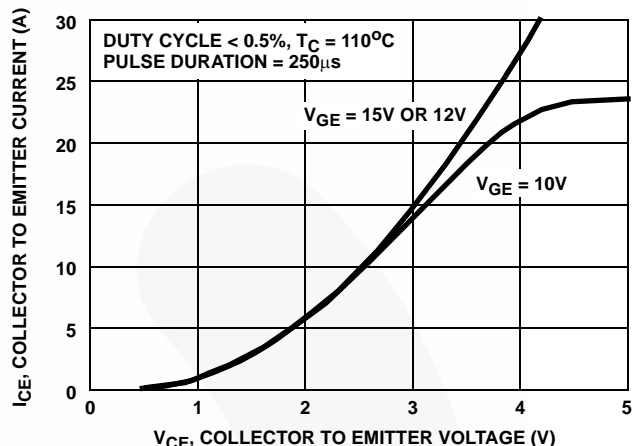

FIGURE 16. COLLECTOR TO EMITTER ON-STATE VOLTAGE

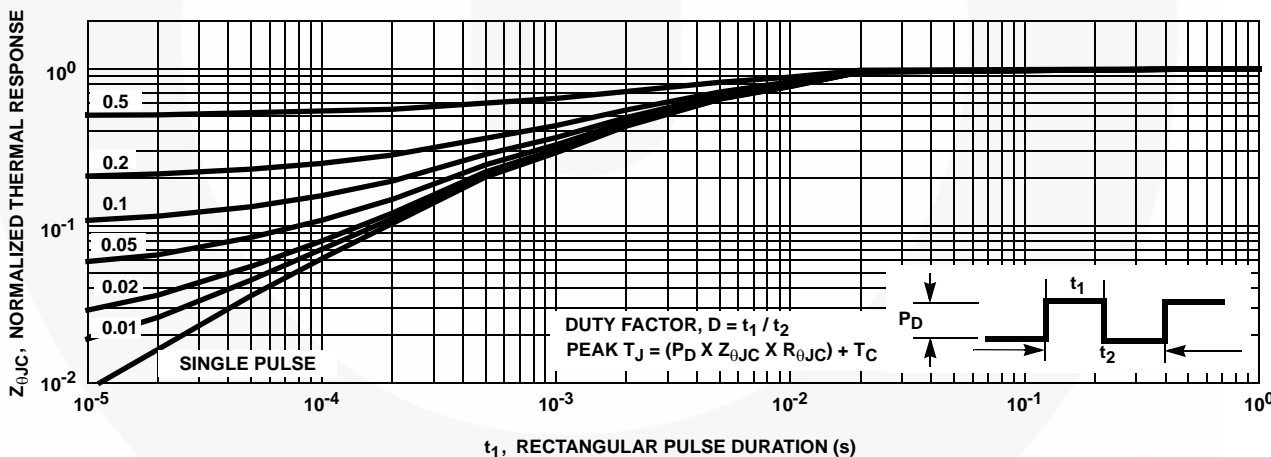

FIGURE 17. NORMALIZED TRANSIENT THERMAL RESPONSE, JUNCTION TO CASE

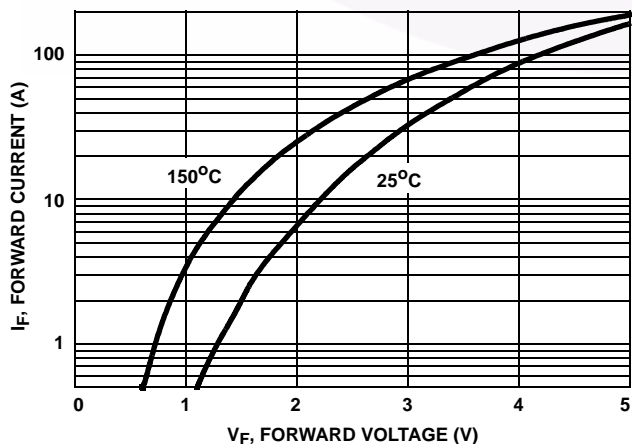

FIGURE 18. DIODE FORWARD CURRENT vs FORWARD VOLTAGE DROP

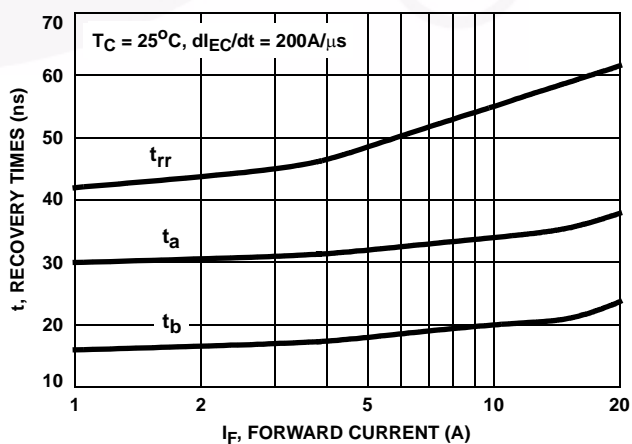

FIGURE 19. RECOVERY TIMES vs FORWARD CURRENT

Test Circuits and Waveforms

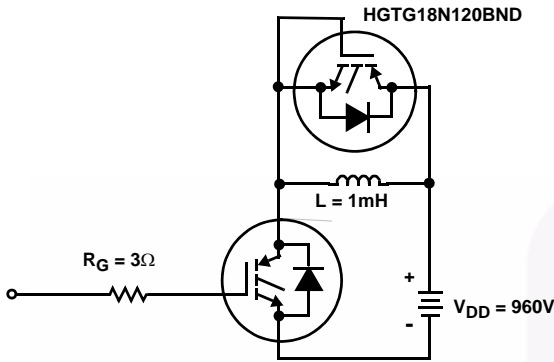

FIGURE 20. INDUCTIVE SWITCHING TEST CIRCUIT

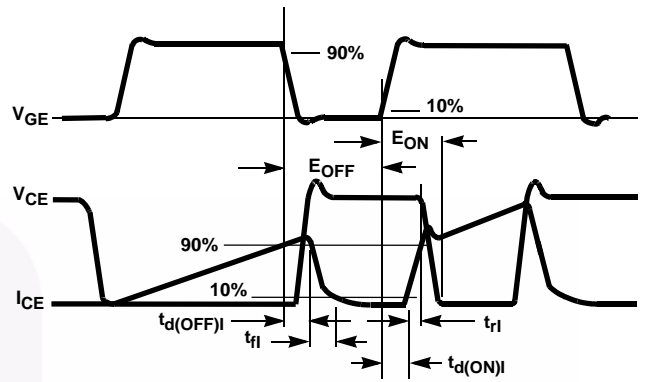

FIGURE 21. SWITCHING TEST WAVEFORMS

Handling Precautions for IGBTs

Insulated Gate Bipolar Transistors are susceptible to gate-insulation damage by the electrostatic discharge of energy through the devices. When handling these devices, care should be exercised to assure that the static charge built in the handler's body capacitance is not discharged through the device. With proper handling and application procedures, however, IGBTs are currently being extensively used in production by numerous equipment manufacturers in military, industrial and consumer applications, with virtually no damage problems due to electrostatic discharge. IGBTs can be handled safely if the following basic precautions are taken:

1. Prior to assembly into a circuit, all leads should be kept shorted together either by the use of metal shorting springs or by the insertion into conductive material such as "ECCOSORB™ LD26" or equivalent.
2. When devices are removed by hand from their carriers, the hand being used should be grounded by any suitable means - for example, with a metallic wristband.
3. Tips of soldering irons should be grounded.
4. Devices should never be inserted into or removed from circuits with power on.
5. **Gate Voltage Rating** - Never exceed the gate-voltage rating of  $V_{GEM}$ . Exceeding the rated  $V_{GE}$  can result in permanent damage to the oxide layer in the gate region.
6. **Gate Termination** - The gates of these devices are essentially capacitors. Circuits that leave the gate open-circuited or floating should be avoided. These conditions can result in turn-on of the device due to voltage buildup on the input capacitor due to leakage currents or pickup.
7. **Gate Protection** - These devices do not have an internal monolithic Zener diode from gate to emitter. If gate protection is required an external Zener is recommended.

Operating Frequency Information

Operating frequency information for a typical device (Figure 3) is presented as a guide for estimating device performance for a specific application. Other typical frequency vs collector current ( $I_{CE}$ ) plots are possible using the information shown for a typical unit in Figures 5, 6, 7, 8, 9 and 11. The operating frequency plot (Figure 3) of a typical device shows  $f_{MAX1}$  or  $f_{MAX2}$ ; whichever is smaller at each point. The information is based on measurements of a typical device and is bounded by the maximum rated junction temperature.

$f_{MAX1}$  is defined by  $f_{MAX1} = 0.05 / (t_{d(OFF)} + t_{d(ON)})$ . Deadtime (the denominator) has been arbitrarily held to 10% of the on-state time for a 50% duty factor. Other definitions are possible.  $t_{d(OFF)}$  and  $t_{d(ON)}$  are defined in Figure 21. Device turn-off delay can establish an additional frequency limiting condition for an application other than  $T_{JM}$ .  $t_{d(OFF)}$  is important when controlling output ripple under a lightly loaded condition.

$f_{MAX2}$  is defined by  $f_{MAX2} = (P_D - P_C) / (E_{OFF} + E_{ON})$ . The allowable dissipation ( $P_D$ ) is defined by  $P_D = (T_{JM} - T_C) / R_{\theta JC}$ . The sum of device switching and conduction losses must not exceed  $P_D$ . A 50% duty factor was used (Figure 3) and the conduction losses ( $P_C$ ) are approximated by  $P_C = (V_{CE} \times I_{CE}) / 2$ .

$E_{ON}$  and  $E_{OFF}$  are defined in the switching waveforms shown in Figure 21.  $E_{ON}$  is the integral of the instantaneous power loss ( $I_{CE} \times V_{CE}$ ) during turn-on and  $E_{OFF}$  is the integral of the instantaneous power loss ( $I_{CE} \times V_{CE}$ ) during turn-off. All tail losses are included in the calculation for  $E_{OFF}$ ; i.e., the collector current equals zero ( $I_{CE} = 0$ ).



Mechanical Dimensions

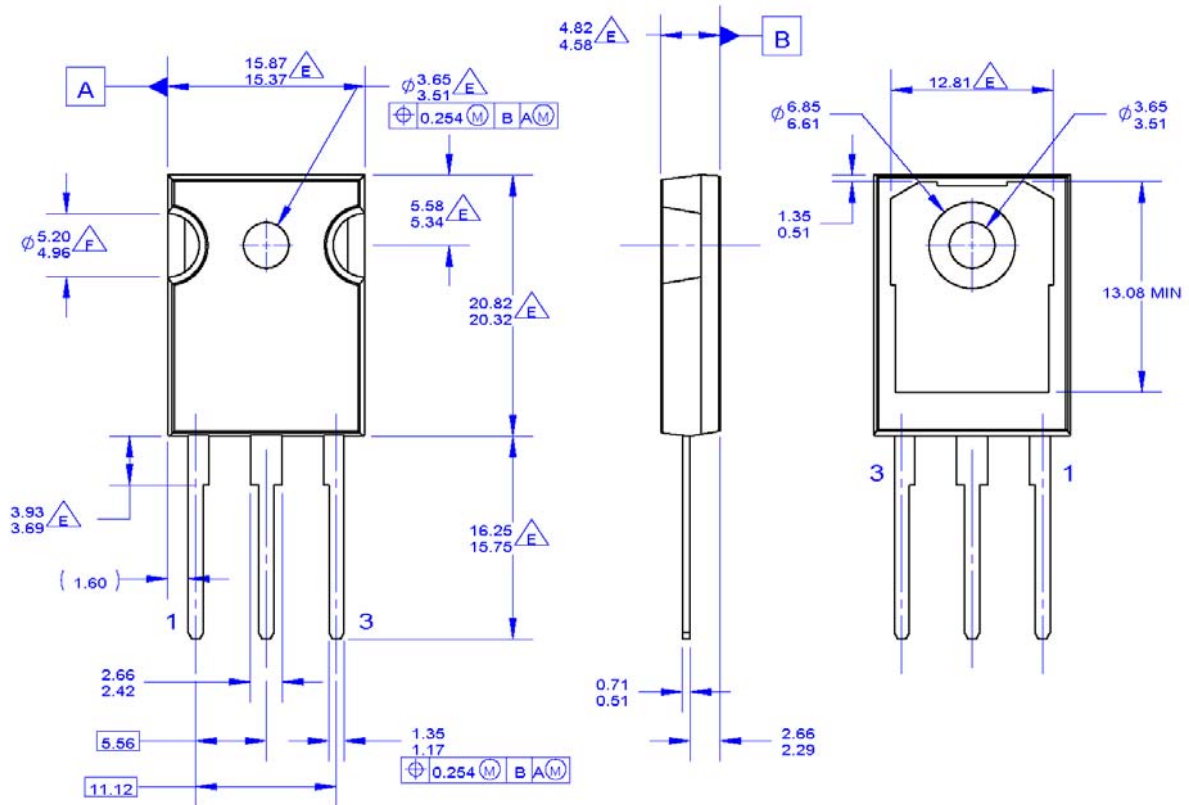

NOTES: UNLESS OTHERWISE SPECIFIED.

- A. PACKAGE REFERENCE: JEDEC TO-247, ISSUE E, VARIATION AB, DATED JUNE, 2004.
- B. DIMENSIONS ARE EXCLUSIVE OF BURRS, MOLD FLASH, AND TIE BAR EXTRUSIONS.
- C. ALL DIMENSIONS ARE IN MILLIMETERS.
- D. DRAWING CONFORMS TO ASME Y14.5 - 1994

- (E) DOES NOT COMPLY JEDEC STANDARD VALUE
- (F) NOTCH MAY BE SQUARE
- G. DRAWING FILENAME: MKT-TO247A03\_REV03

Figure 22. TO-247 3L - TO-247,MOLDED,3 LEAD,JEDEC VARIATION AB

Package drawings are provided as a service to customers considering Fairchild components. Drawings may change in any manner without notice. Please note the revision and/or date on the drawing and contact a Fairchild Semiconductor representative to verify or obtain the most recent revision. Package specifications do not expand the terms of Fairchild's worldwide terms and conditions, specifically the warranty therein, which covers Fairchild products.



Always visit Fairchild Semiconductor's online packaging area for the most recent package drawings:

[http://www.fairchildsemi.com/package/packageDetails.html?id=PN\\_TO247-003](http://www.fairchildsemi.com/package/packageDetails.html?id=PN_TO247-003)

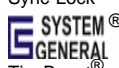

**TRADEMARKS**

The following includes registered and unregistered trademarks and service marks, owned by Fairchild Semiconductor and/or its global subsidiaries, and is not intended to be an exhaustive list of all such trademarks.

- |  |   |                                       |   |
|--|---|---------------------------------------|---|
| AccuPower™   | F-PFST™   | PowerXTrench®                         | Sync-Lock™  |
| AX-CAP®*   | FRFET®  | PowerXS™                              |  SYSTEM GENERAL® |
| BitSiC™  | Global Power Resource <sup>SM</sup>             | Programmable Active Droop™            | TinyBoost®  |
| Build it Now™  | GreenBridge™                                    | QFET®                                 | TinyBuck®   |
| CorePLUS™  | Green FPS™                                      | QS™                                   | TinyCalc™   |
| CorePOWER™   | Green FPS™ e-Series™                            | Quiet Series™                         | TinyLogic®  |
| CROSSVOLT™   | Gmax™   | RapidConfigure™                       | TINYOPTO™   |
| CTL™   | GTO™  | TM                                    | TinyPower™  |
| Current Transfer Logic™  | IntelliMAX™                                     | Saving our world, 1mW/W/kW at a time™ | TinyPWM™  |
| DEUXPEED®  | ISOPLANAR™                                      | SignalWise™                           | TinyWire™   |
| Dual Cool™   | Marking Small Speakers Sound Louder and Better™ | SmartMax™                             | TranSiC™  |
| EcoSPARK®  | MegaBuck™                                       | SMART START™                          | TriFault Detect™  |
| EfficientMax™  | MICROCOUPLER™                                   | Solutions for Your Success™           | TRUECURRENT®*   |
| ESBC™  | MicroFET™                                       | SPM®                                  | µSerDes™  |
|  Fairchild® | MicroPak™                                       | STEALTH™                              |  SerDes®         |
| Fairchild Semiconductor®   | MicroPak2™                                      | SuperFET®                             | Ultra FRFET™  |
| FACT Quiet Series™   | MillerDrive™                                    | SuperSOT™-3                           | UniFET™   |
| FACT®  | MotionMax™                                      | SuperSOT™-6                           | VCX™  |
| FAST®  | mWSaver®  | SuperSOT™-8                           | VisualMax™  |
| FastvCore™   | OptoHiT™  | SupreMOS®                             | VoltagePlus™  |
| FETBench™  | OPTOLOGIC®                                      | SyncFET™                              | XS™   |
| FPST™  | OPTOPLANAR®                                     |                                       |   |

\*Trademarks of System General Corporation, used under license by Fairchild Semiconductor.

**DISCLAIMER**

FAIRCHILD SEMICONDUCTOR RESERVES THE RIGHT TO MAKE CHANGES WITHOUT FURTHER NOTICE TO ANY PRODUCTS HEREIN TO IMPROVE RELIABILITY, FUNCTION, OR DESIGN. FAIRCHILD DOES NOT ASSUME ANY LIABILITY ARISING OUT OF THE APPLICATION OR USE OF ANY PRODUCT OR CIRCUIT DESCRIBED HEREIN; NEITHER DOES IT CONVEY ANY LICENSE UNDER ITS PATENT RIGHTS, NOR THE RIGHTS OF OTHERS. THESE SPECIFICATIONS DO NOT EXPAND THE TERMS OF FAIRCHILD'S WORLDWIDE TERMS AND CONDITIONS, SPECIFICALLY THE WARRANTY THEREIN, WHICH COVERS THESE PRODUCTS.

**LIFE SUPPORT POLICY**

FAIRCHILD'S PRODUCTS ARE NOT AUTHORIZED FOR USE AS CRITICAL COMPONENTS IN LIFE SUPPORT DEVICES OR SYSTEMS WITHOUT THE EXPRESS WRITTEN APPROVAL OF FAIRCHILD SEMICONDUCTOR CORPORATION.

As used here in:

- Life support devices or systems are devices or systems which, (a) are intended for surgical implant into the body or (b) support or sustain life, and (c) whose failure to perform when properly used in accordance with instructions for use provided in the labeling, can be reasonably expected to result in a significant injury of the user.
- A critical component in any component of a life support, device, or system whose failure to perform can be reasonably expected to cause the failure of the life support device or system, or to affect its safety or effectiveness.

**ANTI-COUNTERFEITING POLICY**

Fairchild Semiconductor Corporation's Anti-Counterfeiting Policy. Fairchild's Anti-Counterfeiting Policy is also stated on our external website, www.fairchildsemi.com, under Sales Support.

Counterfeiting of semiconductor parts is a growing problem in the industry. All manufactures of semiconductor products are experiencing counterfeiting of their parts. Customers who inadvertently purchase counterfeit parts experience many problems such as loss of brand reputation, substandard performance, failed application, and increased cost of production and manufacturing delays. Fairchild is taking strong measures to protect ourselves and our customers from the proliferation of counterfeit parts. Fairchild strongly encourages customers to purchase Fairchild parts either directly from Fairchild or from Authorized Fairchild Distributors who are listed by country on our web page cited above. Products customers buy either from Fairchild directly or from Authorized Fairchild Distributors are genuine parts, have full traceability, meet Fairchild's quality standards for handling and storage and provide access to Fairchild's full range of up-to-date technical and product information. Fairchild and our Authorized Distributors will stand behind all warranties and will appropriately address and warranty issues that may arise. Fairchild will not provide any warranty coverage or other assistance for parts bought from Unauthorized Sources. Fairchild is committed to combat this global problem and encourage our customers to do their part in stopping this practice by buying direct or from authorized distributors.

**PRODUCT STATUS DEFINITIONS**

**Definition of Terms**

Datasheet Identification	Product Status	Definition
Advance Information	Formative / In Design	Datasheet contains the design specifications for product development. Specifications may change in any manner without notice.
Preliminary	First Production	Datasheet contains preliminary data; supplementary data will be published at a later date. Fairchild Semiconductor reserves the right to make changes at any time without notice to improve design.
No Identification Needed	Full Production	Datasheet contains final specifications. Fairchild Semiconductor reserves the right to make changes at any time without notice to improve the design.
Obsolete	Not In Production	Datasheet contains specifications on a product that is discontinued by Fairchild Semiconductor. The datasheet is for reference information only.

# Mouser Electronics

Authorized Distributor

Click to View Pricing, Inventory, Delivery & Lifecycle Information:

[Fairchild Semiconductor:](#)

[HGTG18N120BND](#)