



January 2015

# J111 / J112 / J113 / MMBFJ111 / MMBFJ112 / MMBFJ113 N-Channel Switch

## Features

- This device is designed for low level analog switching, sample and hold circuits and chopper stabilized amplifiers.
- Sourced from process 51
- Source & Drain are interchangeable.

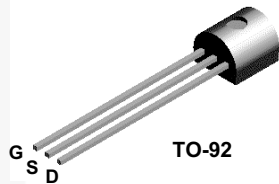

Figure 1. J111 / J112 / J113 Device Package

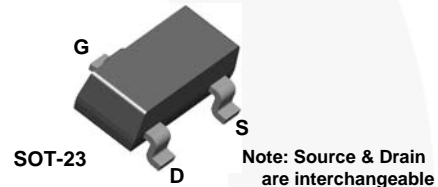

Figure 2. MMBFJ111 / MMBFJ112 / MMBFJ113 Device Package

## Ordering Information

Part Number	Top Mark	Package	Packing Method
J111	J111	TO-92 3L	Bulk
J111_D26Z	J111	TO-92 3L	Tape and Reel
J111_D74Z	J111	TO-92 3L	Ammo
J112	J112	TO-92 3L	Bulk
J112_D26Z	J112	TO-92 3L	Tape and Reel
J112_D27Z	J112	TO-92 3L	Tape and Reel
J112_D74Z	J112	TO-92 3L	Ammo
J113	J113	TO-92 3L	Bulk
J113_D74Z	J113	TO-92 3L	Ammo
J113_D75Z	J113	TO-92 3L	Ammo
MMBFJ111	6P	SOT-23 3L	Tape and Reel
MMBFJ112	6R	SOT-23 3L	Tape and Reel
MMBFJ113	6S	SOT-23 3L	Tape and Reel

J111 / J112 / J113 / MMBFJ111 / MMBFJ112 / MMBFJ113 — N-Channel Switch

## Absolute Maximum Ratings<sup>(1), (2)</sup>

Stresses exceeding the absolute maximum ratings may damage the device. The device may not function or be operable above the recommended operating conditions and stressing the parts to these levels is not recommended. In addition, extended exposure to stresses above the recommended operating conditions may affect device reliability. The absolute maximum ratings are stress ratings only. Values are at  $T_A = 25^\circ\text{C}$  unless otherwise noted.

Symbol	Parameter	Value	Unit
$V_{DG}$	Drain-Gate Voltage	35	V
$V_{GS}$	Gate-Source Voltage	-35	V
$I_{GF}$	Forward Gate Current	50	mA
$T_J, T_{STG}$	Operating and Storage Junction Temperature Range	-55 to 150	$^\circ\text{C}$

### Notes:

1. These ratings are based on a maximum junction temperature of  $150^\circ\text{C}$ .
2. These are steady-state limits. Fairchild Semiconductor should be consulted on applications involving pulsed or low-duty-cycle operations.

## Thermal Characteristics

Values are at  $T_A = 25^\circ\text{C}$  unless otherwise noted.

Symbol	Parameter	Max.		Unit
		J111 / J112 / J113 <sup>(3)</sup>	MMBFJ111 / MMBFJ112 / MMBFJ113 <sup>(4)</sup>	
$P_D$	Total Device Dissipation	625	350	mW
	Derate Above $25^\circ\text{C}$	5.0	2.8	mW/ $^\circ\text{C}$
$R_{\theta JC}$	Thermal Resistance, Junction-to-Case	125		$^\circ\text{C}/\text{W}$
$R_{\theta JA}$	Thermal Resistance, Junction-to-Ambient	200	357	$^\circ\text{C}/\text{W}$

### Notes:

3. PCB size: FR-4, 76 mm x 114 mm x 1.57 mm (3.0 inch x 4.5 inch x 0.062 inch) with minimum land pattern size.
4. Device mounted on FR-4 PCB 36mm x 18mm x 1.5mm; mounting pad for the collector lead minimum  $6\text{cm}^2$ .

## Electrical Characteristics

Values are at  $T_A = 25^\circ\text{C}$  unless otherwise noted.

Symbol	Parameter	Conditions	Min.	Max.	Unit	
<b>Off Characteristics</b>						
$V_{(BR)GSS}$	Gate-Source Breakdown Voltage	$I_G = -1.0 \mu\text{A}, V_{DS} = 0$	-35		V	
$I_{GSS}$	Gate Reverse Current	$V_{GS} = -15 \text{ V}, V_{DS} = 0$		-1.0	nA	
$V_{GS(off)}$	Gate-Source Cut-Off Voltage	$V_{DS} = 15 \text{ V}, I_D = 1.0 \mu\text{A}$	111	-3.0	-10.0	V
			112	-1.0	-5.0	
			113	-0.5	-3.0	
$I_{D(off)}$	Drain Cutoff Leakage Current	$V_{DS} = 5.0 \text{ V}, V_{GS} = -10 \text{ V}$		1.0	nA	
<b>On Characteristics</b>						
$I_{DSS}$	Zero-Gate Voltage Drain Current <sup>(5)</sup>	$V_{DS} = 15 \text{ V}, V_{GS} = 0$	111	20		mA
			112	5.0		
			113	2.0		
$r_{DS(on)}$	Drain-Source On Resistance	$V_{DS} \leq 0.1 \text{ V}, V_{GS} = 0$	111		30	$\Omega$
			112		50	
			113		100	
<b>Small Signal Characteristics</b>						
$C_{dg(on)}$ $C_{sg(on)}$	Drain-Gate & Source-Gate On Capacitance	$V_{DS} = 0, V_{GS} = 0, f = 1.0 \text{ MHz}$		28	pF	
$C_{dg(off)}$	Drain-Gate Off Capacitance	$V_{DS} = 0, V_{GS} = -10 \text{ V}, f = 1.0 \text{ MHz}$		5.0	pF	
$C_{sg(off)}$	Source-Gate Off Capacitance	$V_{DS} = 0, V_{GS} = -10 \text{ V}, f = 1.0 \text{ MHz}$		5.0	pF	

**Note:**

5. Pulse test: pulse width  $\leq 300 \mu\text{s}$ , duty cycle  $\leq 2\%$ .

### Typical Performance Characteristics

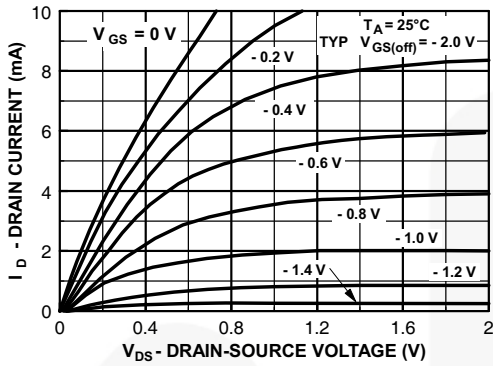

Figure 3. Common Drain-Source

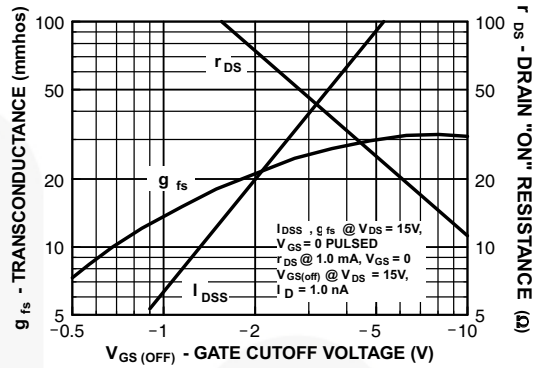

Figure 4. Parameter Interactions

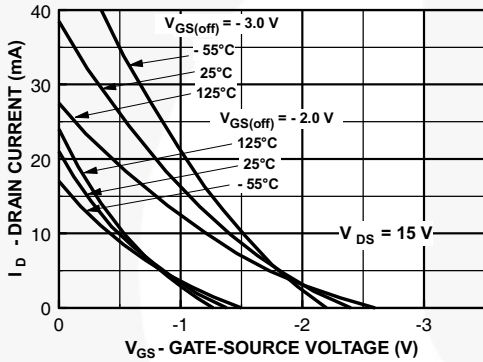

Figure 5. Transfer Characteristics

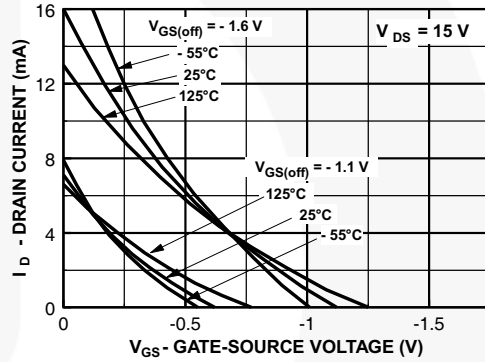

Figure 6. Transfer Characteristics

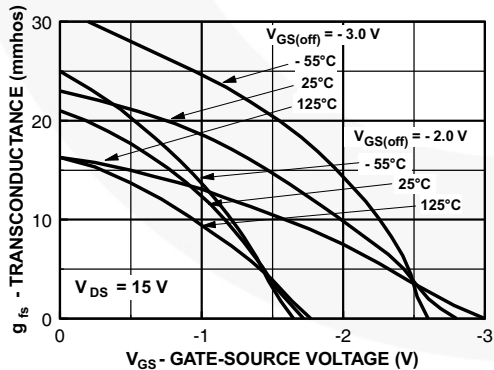

Figure 7. Transfer Characteristics

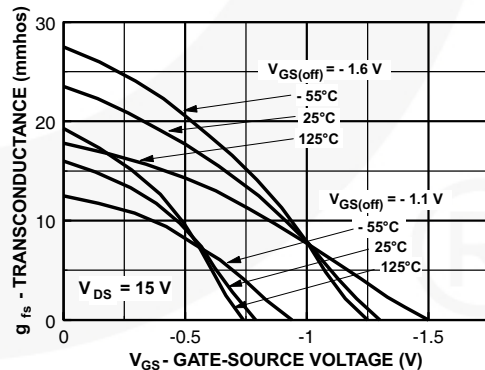

Figure 8. Transfer Characteristics

Typical Performance Characteristics (Continued)

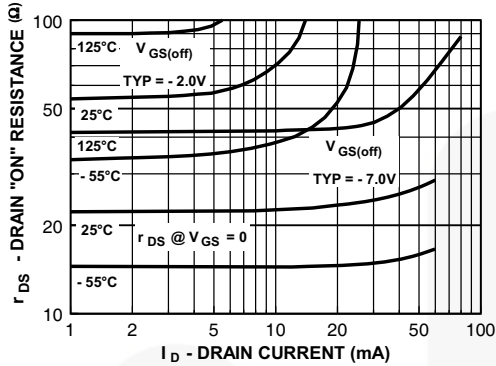

Figure 9. On Resistance vs. Drain Current

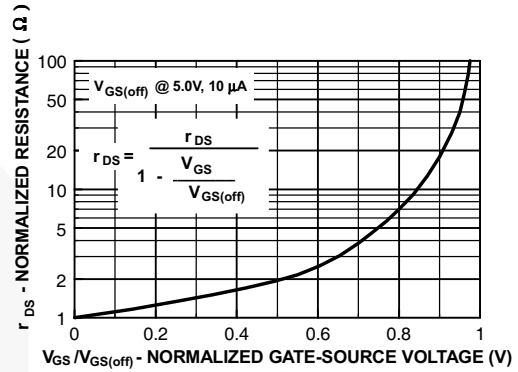

Figure 10. Normalized Drain Resistance vs. Bias Voltage

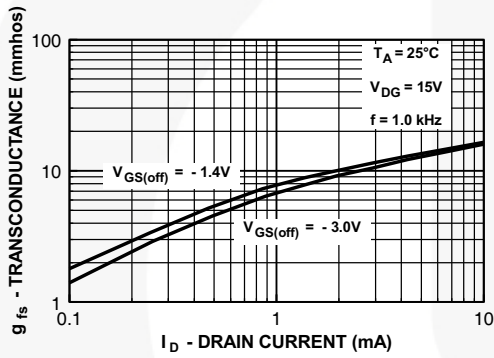

Figure 11. Transconductance vs. Drain Current

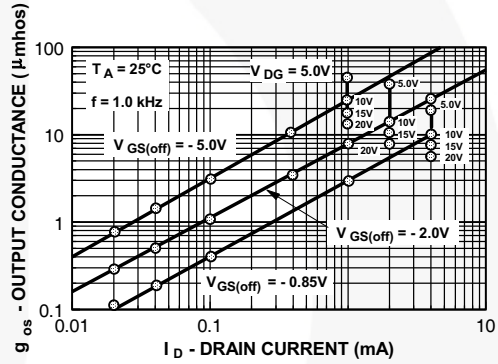

Figure 12. Output Conductance vs. Drain Current

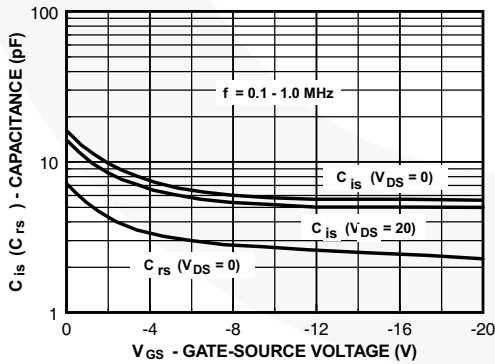

Figure 13. Capacitance vs. Voltage

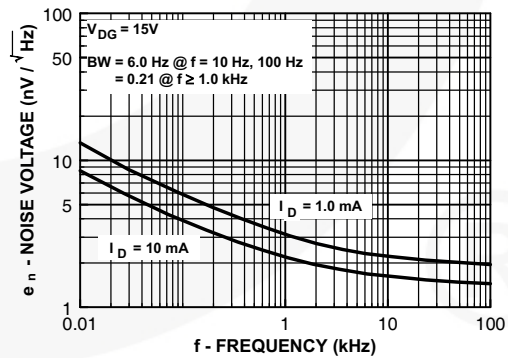

Figure 14. Noise Voltage vs. Frequency

Typical Performance Characteristics (Continued)

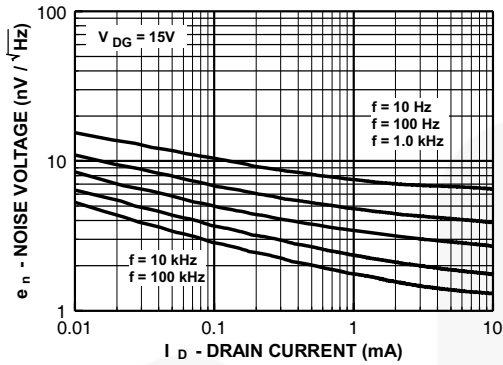

Figure 15. Noise Voltage vs. Current

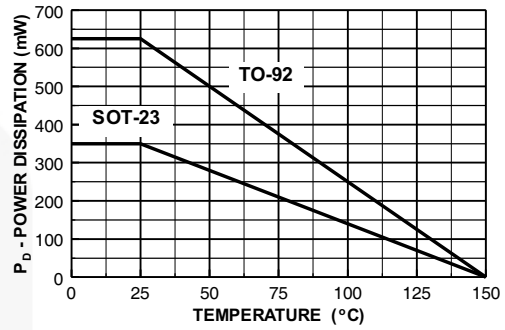

Figure 16. Power Dissipation vs. Ambient Temperature

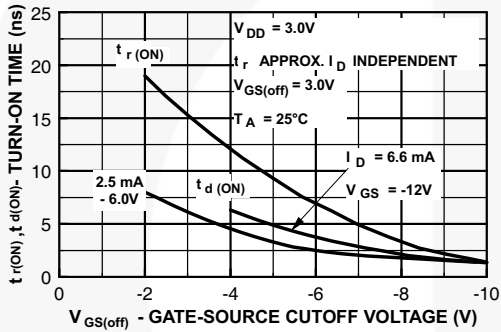

Figure 17. Switching Turn-On Time vs. Gate-Source Voltage

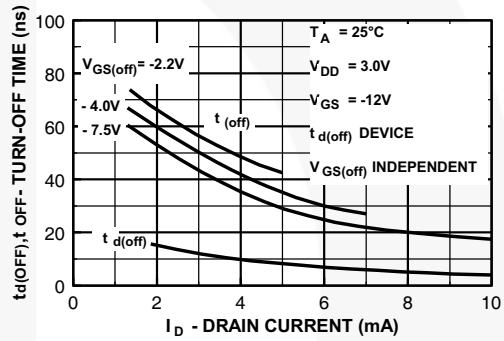
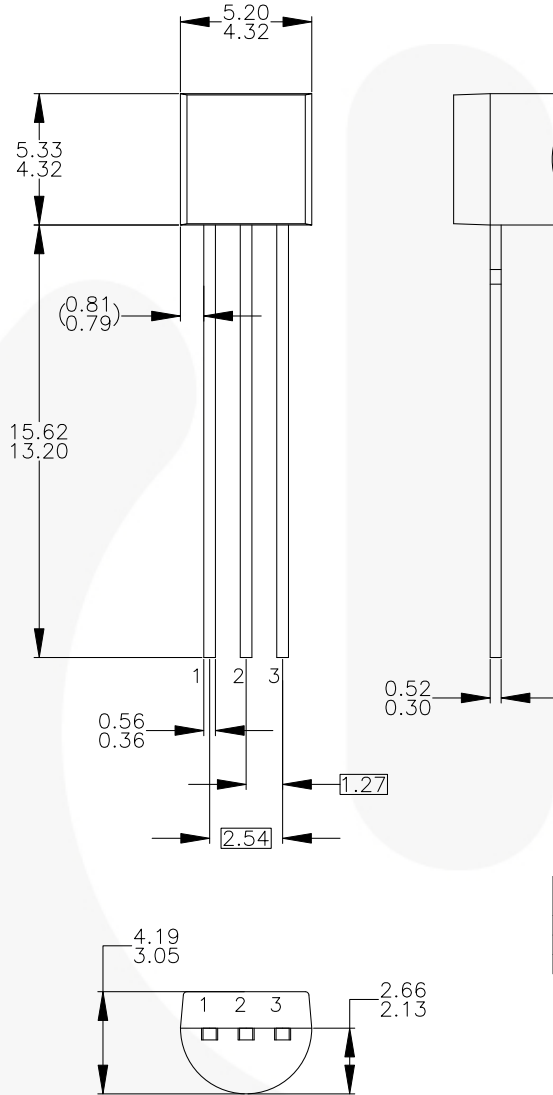

Figure 18. Switching Turn-Off Time vs. Drain Current

Physical Dimensions



NOTES: UNLESS OTHERWISE SPECIFIED

- A) DRAWING WITH REFERENCE TO JEDEC TO-92 RECOMMENDATIONS.
- B) ALL DIMENSIONS ARE IN MILLIMETERS.
- C) DRAWING CONFORMS TO ASME Y14.5M-1994.
- D) TO-92 (92,94,96,97,98) PIN CONFIGURATION:

PIN	92			94			96			97			98		
	P	F	M	P	F	M	B	F	M	P	F	M	P	F	M
1	E	S	S	E	S	S	B	D	G	C	G	D	C	G	D
2	B	D	G	C	G	D	E	S	S	B	D	G	E	S	S
3	C	G	D	B	D	G	C	G	D	E	S	S	B	D	G

LEGEND:

- P - BIPOLAR
- F - JFET
- M - DMOS
- E - EMITTER
- B - BASE
- C - COLLECTOR
- D - DRAIN
- S - SOURCE
- G - GATE

- E) FOR PACKAGE 92, 94, 96, 97 AND 98: PIN CONFIGURATION DRAIN "D" AND SOURCE "S" ARE INTERCHANGEABLE AT JFET "F" OPTION.
- F) DRAWING FILENAME: MKT-ZA03DREV3.

Figure 19. 3-Lead, TO-92, JEDEC TO-92 Compliant Straight Lead Configuration, Bulk Type

Physical Dimensions (Continued)

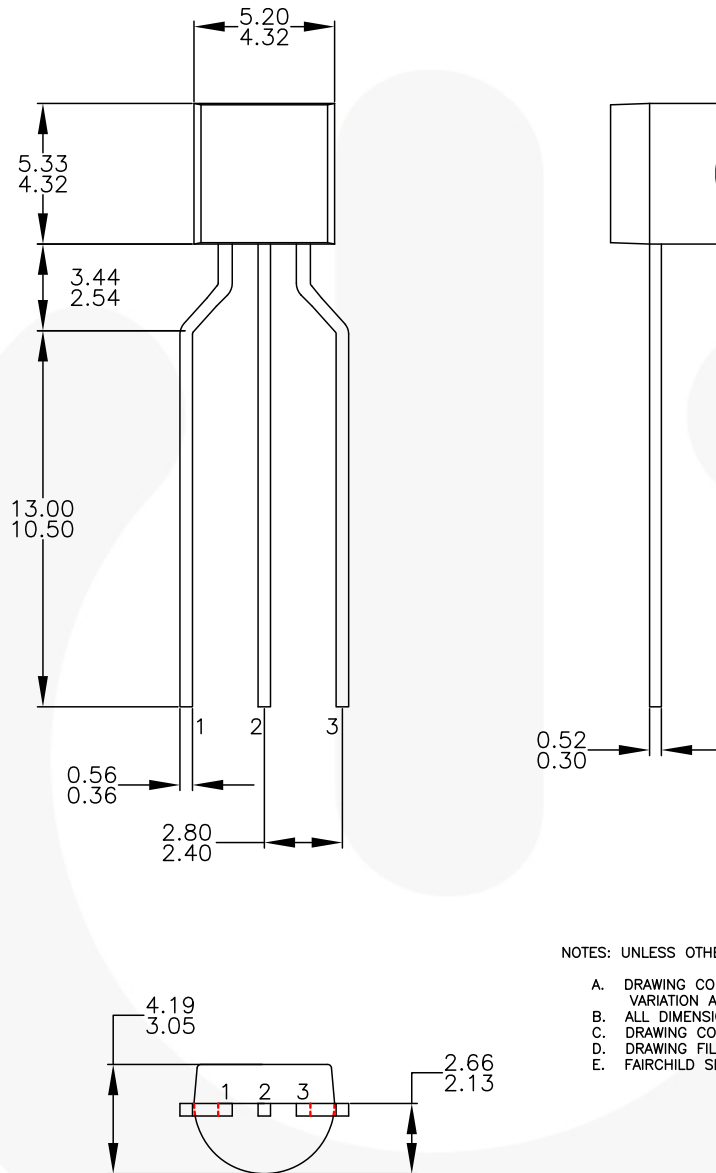

NOTES: UNLESS OTHERWISE SPECIFIED

- A. DRAWING CONFORMS TO JEDEC MS-013, VARIATION AC.
- B. ALL DIMENSIONS ARE IN MILLIMETERS.
- C. DRAWING CONFORMS TO ASME Y14.5M-2009.
- D. DRAWING FILENAME: MKT-ZA03FREV3.
- E. FAIRCHILD SEMICONDUCTOR.

Figure 20. 3-Lead, TO-92, Molded, 0.2 In Line Spacing Lead Form, Ammo, Tape and Reel Type



Physical Dimensions (Continued)

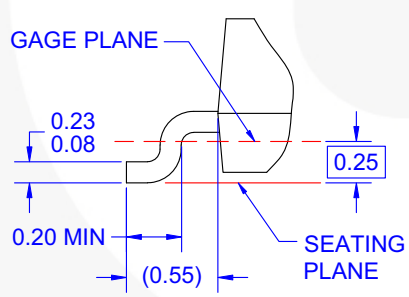
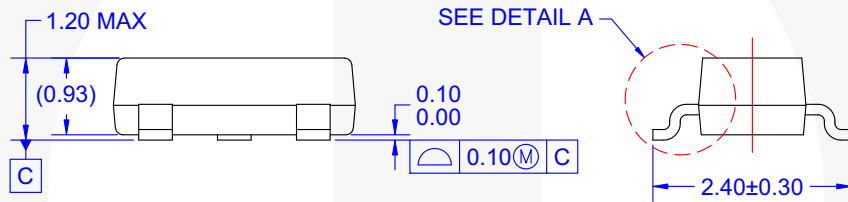
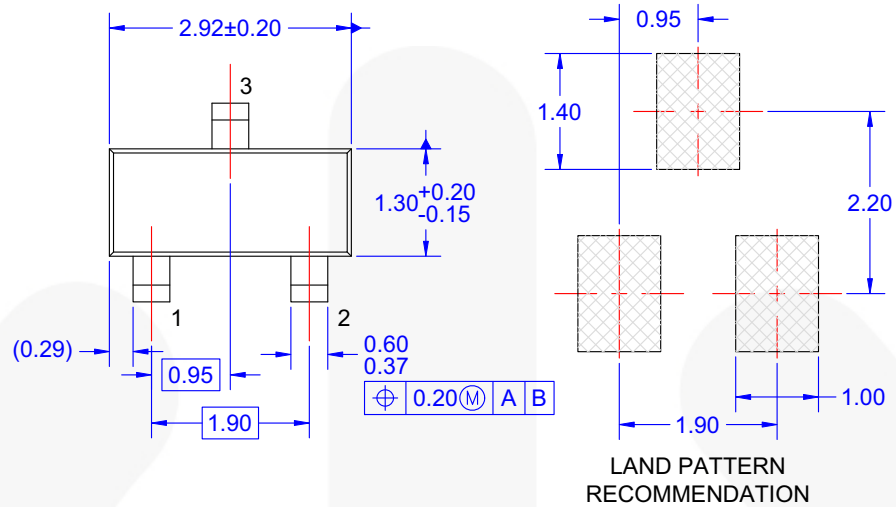

- NOTES: UNLESS OTHERWISE SPECIFIED
- A) REFERENCE JEDEC REGISTRATION TO-236, VARIATION AB, ISSUE H.
  - B) ALL DIMENSIONS ARE IN MILLIMETERS.
  - C) DIMENSIONS ARE INCLUSIVE OF BURRS, MOLD FLASH AND TIE BAR EXTRUSIONS.
  - D) DIMENSIONING AND TOLERANCING PER ASME Y14.5M - 1994.
  - E) DRAWING FILE NAME: MA03DREV10





**DETAIL A**  
SCALE: 2X

**Figure 21. 3-LEAD, SOT23, JEDEC TO-236, LOW PROFILE**



### TRADEMARKS

The following includes registered and unregistered trademarks and service marks, owned by Fairchild Semiconductor and/or its global subsidiaries, and is not intended to be an exhaustive list of all such trademarks.

AccuPower™	F-PFS™	OPTOPLANAR®	 SYSTEM GENERAL®
AttitudeEngine™	FRFET®	 ®	TinyBoost®
Awinda®	Global Power Resource™	PowerTrench®	TinyBuck®
AX-CAP®*	GreenBridge™	PowerXS™	TinyCalc™
BitSiC™	Green FPS™	Programmable Active Droop™	TinyLogic®
Build it Now™	Green FPS™ e-Series™	QFET®	TINYOPTO™
CorePLUS™	Gmax™	QS™	TinyPower™
CorePOWER™	GTO™	Quiet Series™	TinyPWM™
CROSSVOLT™	IntelliMAX™	RapidConfigure™	TinyWire™
CTL™	ISOPLANAR™	 ™	TranSiC™
Current Transfer Logic™	Making Small Speakers Sound Louder and Better™	Saving our world, 1mW/W/kW at a time™	TriFault Detect™
DEUXPEED®	MegaBuck™	SignalWise™	TRUECURRENT®*
Dual Cool™	MICROCOUPLER™	SmartMax™	µSerDes™
EcoSPARK®	MicroFET™	SMART START™	 SerDes™
EfficientMax™	MicroPak™	Solutions for Your Success™	UHC®
ESBC™	MicroPak2™	SPM®	Ultra FRFET™
 Fairchild®	MillerDrive™	STEALTH™	UniFET™
Fairchild Semiconductor®	MotionMax™	SuperFET®	VCX™
FACT Quiet Series™	MotionGrid®	SuperSOT™-3	VisualMax™
FACT®	MTi®	SuperSOT™-6	VoltagePlus™
FAST®	MTx®	SuperSOT™-8	XS™
FastvCore™	MVN®	SupreMOS®	Xsens™
FETBench™	mWSaver®	SyncFET™	仙童™
FPS™	OptoHiT™	Sync-Lock™	
	OPTOLOGIC®		

\* Trademarks of System General Corporation, used under license by Fairchild Semiconductor.

### DISCLAIMER

FAIRCHILD SEMICONDUCTOR RESERVES THE RIGHT TO MAKE CHANGES WITHOUT FURTHER NOTICE TO ANY PRODUCTS HEREIN TO IMPROVE RELIABILITY, FUNCTION, OR DESIGN. TO OBTAIN THE LATEST, MOST UP-TO-DATE DATASHEET AND PRODUCT INFORMATION, VISIT OUR WEBSITE AT [HTTP://WWW.FAIRCHILDSEMI.COM](http://www.fairchildsemi.com). FAIRCHILD DOES NOT ASSUME ANY LIABILITY ARISING OUT OF THE APPLICATION OR USE OF ANY PRODUCT OR CIRCUIT DESCRIBED HEREIN; NEITHER DOES IT CONVEY ANY LICENSE UNDER ITS PATENT RIGHTS, NOR THE RIGHTS OF OTHERS. THESE SPECIFICATIONS DO NOT EXPAND THE TERMS OF FAIRCHILD'S WORLDWIDE TERMS AND CONDITIONS, SPECIFICALLY THE WARRANTY THEREIN, WHICH COVERS THESE PRODUCTS.

### LIFE SUPPORT POLICY

FAIRCHILD'S PRODUCTS ARE NOT AUTHORIZED FOR USE AS CRITICAL COMPONENTS IN LIFE SUPPORT DEVICES OR SYSTEMS WITHOUT THE EXPRESS WRITTEN APPROVAL OF FAIRCHILD SEMICONDUCTOR CORPORATION.

As used herein:

1. Life support devices or systems are devices or systems which, (a) are intended for surgical implant into the body or (b) support or sustain life, and (c) whose failure to perform when properly used in accordance with instructions for use provided in the labeling, can be reasonably expected to result in a significant injury of the user.
2. A critical component in any component of a life support, device, or system whose failure to perform can be reasonably expected to cause the failure of the life support device or system, or to affect its safety or effectiveness.

### ANTI-COUNTERFEITING POLICY

Fairchild Semiconductor Corporation's Anti-Counterfeiting Policy. Fairchild's Anti-Counterfeiting Policy is also stated on our external website, [www.fairchildsemi.com](http://www.fairchildsemi.com), under Sales Support.

Counterfeiting of semiconductor parts is a growing problem in the industry. All manufacturers of semiconductor products are experiencing counterfeiting of their parts. Customers who inadvertently purchase counterfeit parts experience many problems such as loss of brand reputation, substandard performance, failed applications, and increased cost of production and manufacturing delays. Fairchild is taking strong measures to protect ourselves and our customers from the proliferation of counterfeit parts. Fairchild strongly encourages customers to purchase Fairchild parts either directly from Fairchild or from Authorized Fairchild Distributors who are listed by country on our web page cited above. Products customers buy either from Fairchild directly or from Authorized Fairchild Distributors are genuine parts, have full traceability, meet Fairchild's quality standards for handling and storage and provide access to Fairchild's full range of up-to-date technical and product information. Fairchild and our Authorized Distributors will stand behind all warranties and will appropriately address any warranty issues that may arise. Fairchild will not provide any warranty coverage or other assistance for parts bought from Unauthorized Sources. Fairchild is committed to combat this global problem and encourage our customers to do their part in stopping this practice by buying direct or from authorized distributors.

### PRODUCT STATUS DEFINITIONS

#### Definition of Terms

Datasheet Identification	Product Status	Definition
Advance Information	Formative / In Design	Datasheet contains the design specifications for product development. Specifications may change in any manner without notice.
Preliminary	First Production	Datasheet contains preliminary data; supplementary data will be published at a later date. Fairchild Semiconductor reserves the right to make changes at any time without notice to improve design.
No Identification Needed	Full Production	Datasheet contains final specifications. Fairchild Semiconductor reserves the right to make changes at any time without notice to improve the design.
Obsolete	Not In Production	Datasheet contains specifications on a product that is discontinued by Fairchild Semiconductor. The datasheet is for reference information only.

Rev. I73

# Mouser Electronics

Authorized Distributor

Click to View Pricing, Inventory, Delivery & Lifecycle Information:

[Fairchild Semiconductor:](#)

[J111\\_Q](#) [J111\\_D27Z](#) [J111\\_D26Z](#) [J111\\_D75Z](#) [J111\\_D74Z](#) [J111](#) [J111\\_D74Z\\_Q](#)