



November 2014

# MMBT2369A NPN Switching Transistor

## Description

This device is designed for high speed saturated switching at collector currents of 10 mA to 100 mA. Sourced from process 21.

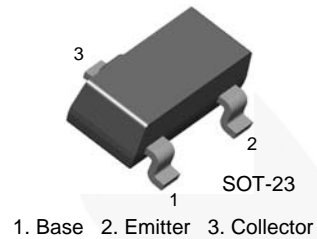

## Ordering Information

| Part Number | Marking | Package   | Packing Method |
|-------------|---------|-----------|----------------|
| MMBT2369A   | 1S      | SOT-23 3L | Tape and Reel  |

## Absolute Maximum Ratings<sup>(1),(2)</sup>

Stresses exceeding the absolute maximum ratings may damage the device. The device may not function or be operable above the recommended operating conditions and stressing the parts to these levels is not recommended. In addition, extended exposure to stresses above the recommended operating conditions may affect device reliability. The absolute maximum ratings are stress ratings only. Values are at  $T_A = 25^\circ\text{C}$  unless otherwise noted.

| Symbol         | Parameter  | Value       | Unit             |
|----------------|--|-------------|------------------|
| $V_{CEO}$      | Collector-Emitter Voltage                        | 15          | V                |
| $V_{CBO}$      | Collector-Base Voltage                           | 40          | V                |
| $V_{EBO}$      | Emitter-Base Voltage                             | 4.5         | V                |
| $I_C$          | Collector Current - Continuous                   | 200         | mA               |
| $T_J, T_{STG}$ | Operating and Storage Junction Temperature Range | -55 to +150 | $^\circ\text{C}$ |

### Notes:

1. These ratings are based on a maximum junction temperature of  $150^\circ\text{C}$ .
2. These are steady-state limits. Fairchild Semiconductor should be consulted on applications involving pulsed or low-duty-cycle operations.

**Thermal Characteristics<sup>(3)</sup>**

Values are at  $T_A = 25^\circ\text{C}$  unless otherwise noted.

| Symbol    | Parameter                               | Value | Unit                      |
|-----------|---|-------|---------------------------|
| $P_D$     | Total Device Dissipation                | 225   | mW                        |
|           | Derate Above $25^\circ\text{C}$         | 1.8   | mW/ $^\circ\text{C}$      |
| $R_{qJA}$ | Thermal Resistance, Junction-to-Ambient | 556   | $^\circ\text{C}/\text{W}$ |

**Note:**

3. Device is mounted on FR-4 PCB 1.6 inch X 1.6 inch X 0.06 inch.

**Electrical Characteristics**

Values are at  $T_A = 25^\circ\text{C}$  unless otherwise noted.

| Symbol        | Parameter   | Conditions   | Min. | Max. | Unit          |
|---------------|---|--|------|------|---------------|
| $BV_{CEO}$    | Collector-Emitter Breakdown Voltage <sup>(4)</sup>  | $I_C = 10\text{ mA}, I_B = 0$  | 15   |      | V             |
| $BV_{CES}$    | Collector-Emitter Breakdown Voltage                 | $I_C = 10\ \mu\text{A}, V_{BE} = 0$  | 40   |      | V             |
| $BV_{CBO}$    | Collector-Base Breakdown Voltage                    | $I_C = 10\ \mu\text{A}, I_E = 0$   | 40   |      | V             |
| $BV_{EBO}$    | Emitter-Base Breakdown Voltage                      | $I_E = 10\ \mu\text{A}, I_C = 0$   | 4.5  |      | V             |
| $I_{CBO}$     | Collector Cut-Off Current                           | $V_{CB} = 20\text{ V}, I_E = 0$  |      | 0.4  | $\mu\text{A}$ |
|               |   | $V_{CB} = 20\text{ V}, I_E = 0, T_A = 125^\circ\text{C}$   |      | 30   |               |
| $h_{FE}$      | DC Current Gain <sup>(4)</sup>                      | $I_C = 10\text{ mA}, V_{CE} = 1.0\text{ V}$  | 40   | 120  |               |
|               |   | $I_C = 10\text{ mA}, V_{CE} = 0.35\text{ V}, T_A = -55^\circ\text{C}$                            | 20   |      |               |
|               |   | $I_C = 100\text{ mA}, V_{CE} = 1.0\text{ V}$   | 20   |      |               |
| $V_{CE(sat)}$ | Collector-Emitter Saturation Voltage <sup>(4)</sup> | $I_C = 10\text{ mA}, I_B = 1.0\text{ mA}$  |      | 0.20 | V             |
|               |   | $I_C = 10\text{ mA}, I_B = 1.0\text{ mA}, T_A = 125^\circ\text{C}$                               |      | 0.30 |               |
|               |   | $I_C = 30\text{ mA}, I_B = 3.0\text{ mA}$  |      | 0.25 |               |
|               |   | $I_C = 100\text{ mA}, I_B = 10\text{ mA}$  |      | 0.50 |               |
| $V_{BE(sat)}$ | Base-Emitter Saturation Voltage                     | $I_C = 10\text{ mA}, I_B = 1.0\text{ mA}$  | 0.70 | 0.85 | V             |
|               |   | $I_C = 10\text{ mA}, I_B = 1.0\text{ mA}, T_A = -55^\circ\text{C}$                               |      | 1.02 |               |
|               |   | $I_C = 10\text{ mA}, I_B = 1.0\text{ mA}, T_A = 125^\circ\text{C}$                               | 0.59 |      |               |
|               |   | $I_C = 30\text{ mA}, I_B = 3.0\text{ mA}$  |      | 1.15 |               |
|               |   | $I_C = 100\text{ mA}, I_B = 10\text{ mA}$  |      | 1.60 |               |
| $C_{obo}$     | Output Capacitance                                  | $V_{CB} = 5.0\text{ V}, I_E = 0, f = 1.0\text{ MHz}$   |      | 4.0  | pF            |
| $C_{ibo}$     | Input Capacitance                                   | $V_{EB} = 0.5\text{ V}, I_C = 0, f = 1.0\text{ MHz}$   |      | 5.0  | pF            |
| $h_{fe}$      | Small-Signal Current Gain                           | $I_C = 10\text{ mA}, V_{CE} = 10\text{ V}$<br>$R_G = 2.0\text{ k}\Omega, f = 100\text{ MHz}$     | 5.0  |      |               |
| $t_s$         | Storage Time  | $I_{B1} = I_{B2} = I_C = 10\text{ mA}$   |      | 13   | ns            |
| $t_{on}$      | Turn-On Time  | $V_{CC} = 3.0\text{ V}, I_C = 10\text{ mA},$<br>$I_{B1} = 3.0\text{ mA}$                         |      | 12   | ns            |
| $t_{off}$     | Turn-Off Time                                       | $V_{CC} = 3.0\text{ V}, I_C = 10\text{ mA},$<br>$I_{B1} = 3.0\text{ mA}, I_{B2} = 1.5\text{ mA}$ |      | 18   | ns            |

**Note:**

4. Pulse test: Pulse width  $\leq 300\ \mu\text{s}$ , duty cycle  $\leq 2\%$

Typical Performance Characteristics

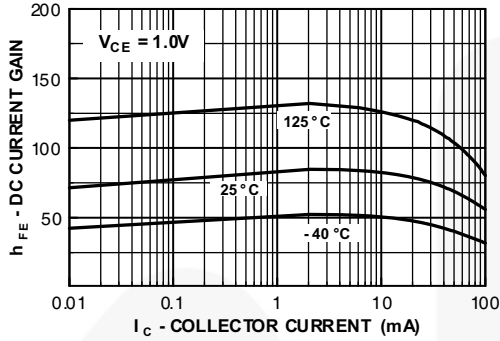

Figure 1. DC Current Gain vs. Collector Current

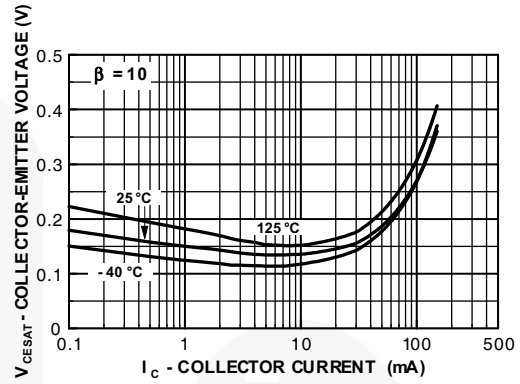

Figure 2. Collector-Emitter Saturation Voltage vs. Collector Current

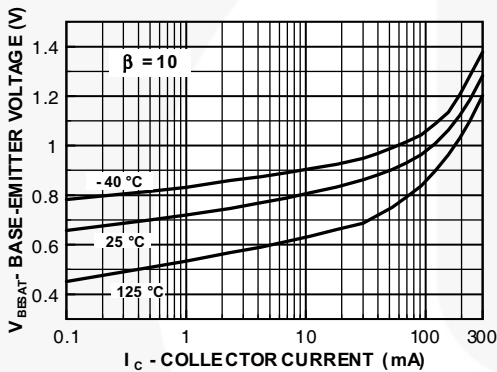

Figure 3. Base-Emitter Saturation Voltage vs. Collector Current

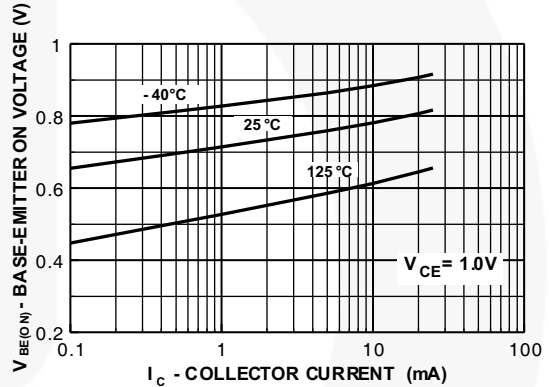

Figure 4. Base-Emitter On Voltage vs. Collector Current

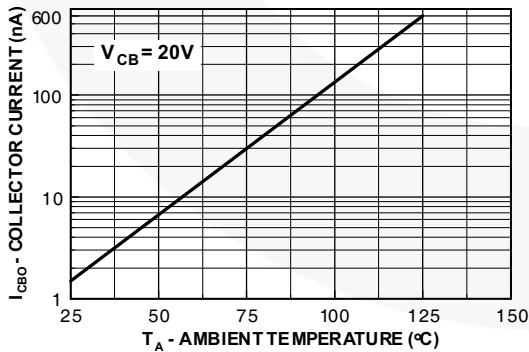

Figure 5. Collector Cut-Off Current vs. Ambient Temperature

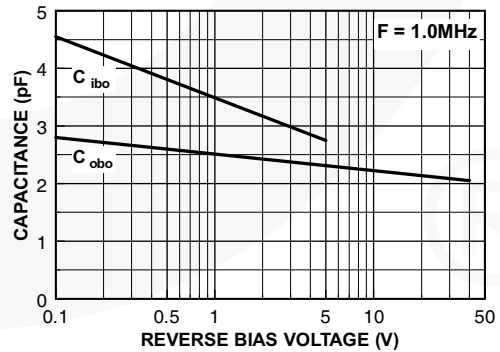

Figure 6. Output Capacitance vs. Reverse Bias Voltage

Typical Performance Characteristics (Continued)

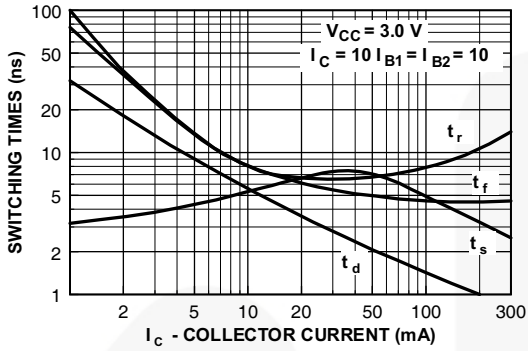

Figure 7. Switching Times vs. Collector Current

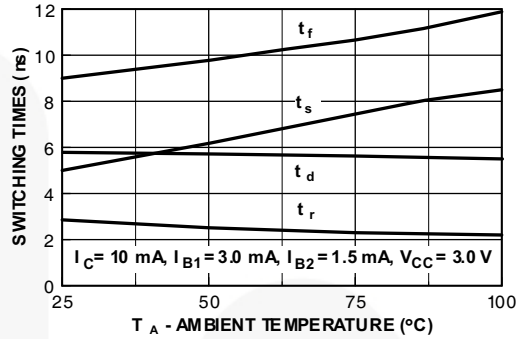

Figure 8. Switching Times vs. Ambient Temperature

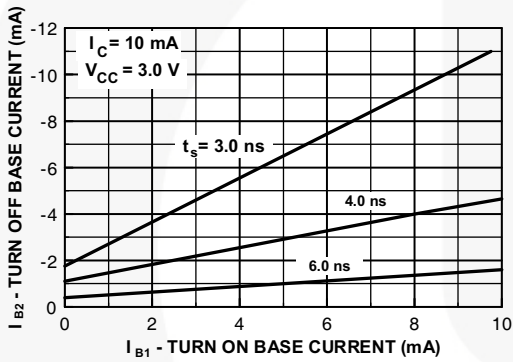

Figure 9. Storage Time vs. Turn-On and Turn-Off Base Currents

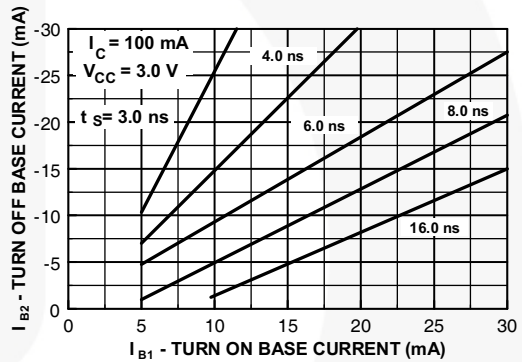

Figure 10. Storage Time vs. Turn-On and Turn-Off Base Currents

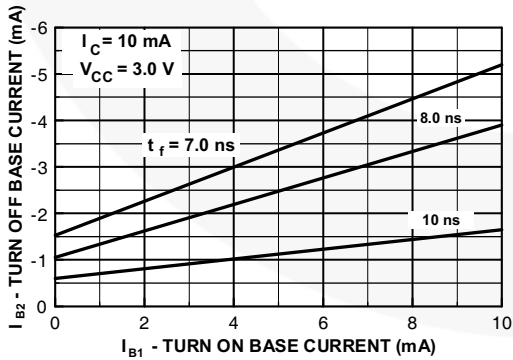

Figure 11. Fall Time vs. Turn-On and Turn-Off Base Currents

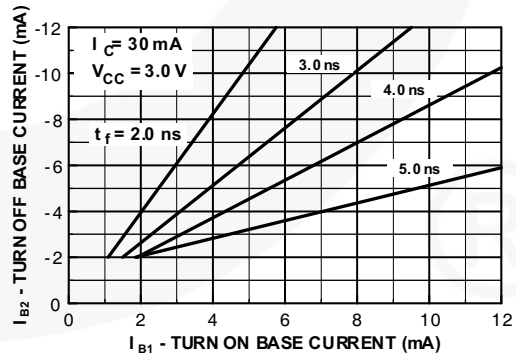

Figure 12. Fall Time vs. Turn-On and Turn-Off Base Currents

Typical Performance Characteristics (Continued)

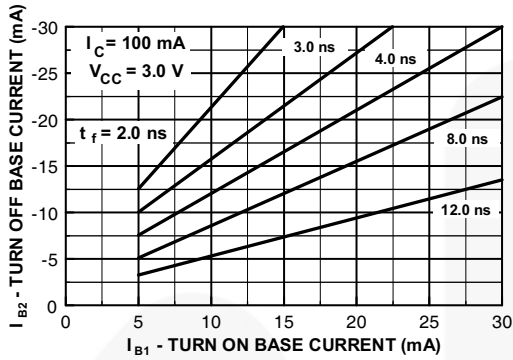

Figure 13. Fall Time vs. Turn-On and Turn-Off Base Currents

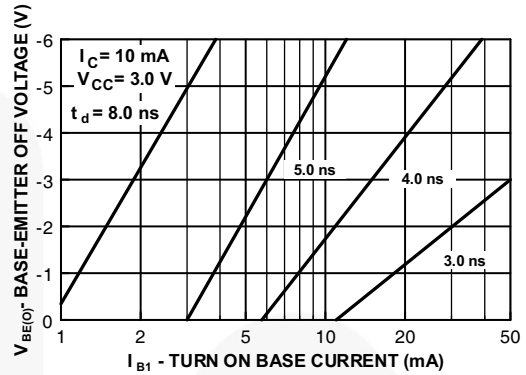

Figure 14. Delay Time vs. Base-Emitter Off Voltage and Turn-On Base Current

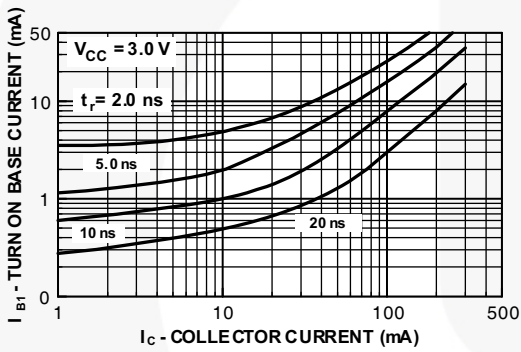

Figure 15. Rise Time vs. Turn-On Base Current and Collector Current

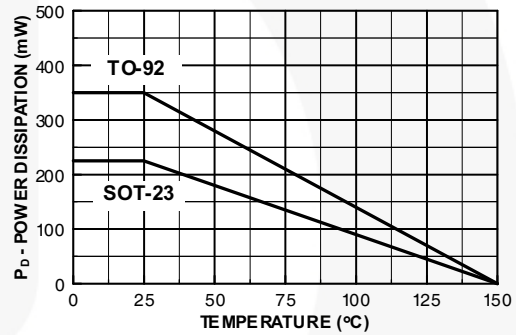
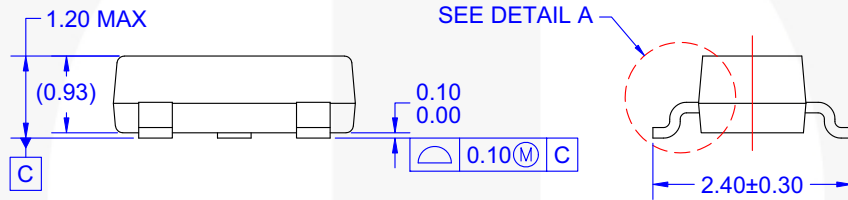
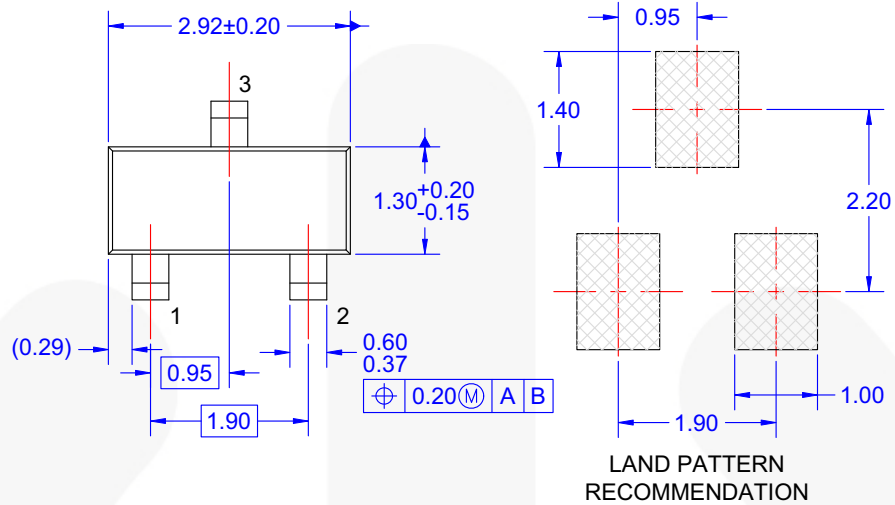

Figure 16. Power Dissipation vs. Ambient Temperature

Physical Dimensions



NOTES: UNLESS OTHERWISE SPECIFIED

- A) REFERENCE JEDEC REGISTRATION TO-236, VARIATION AB, ISSUE H.
- B) ALL DIMENSIONS ARE IN MILLIMETERS.
- C) DIMENSIONS ARE INCLUSIVE OF BURRS, MOLD FLASH AND TIE BAR EXTRUSIONS.
- D) DIMENSIONING AND TOLERANCING PER ASME Y14.5M - 1994.
- E) DRAWING FILE NAME: MA03DREV10

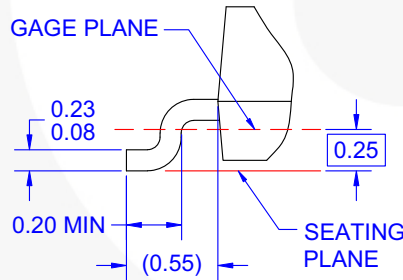





**DETAIL A**  
SCALE: 2X

**Figure 17. 3-LEAD, SOT23, JEDEC TO-236, LOW PROFILE**



### TRADEMARKS

The following includes registered and unregistered trademarks and service marks, owned by Fairchild Semiconductor and/or its global subsidiaries, and is not intended to be an exhaustive list of all such trademarks.

- |  |  |   |   |
|--|--|---|---|
| AccuPower™   | F-PFS™   | OPTOPLANAR®   |  SYSTEM GENERAL® |
| Awinda®  | FRFET®   |  ® | TinyBoost®  |
| AX-CAP®*   | Global Power Resource™                         | PowerTrench®  | TinyBuck®   |
| BitSiC™  | GreenBridge™                                   | PowerXS™  | TinyCalc™   |
| Build it Now™  | Green FPS™                                     | Programmable Active Droop™  | TinyLogic®  |
| CorePLUS™  | Green FPS™ e-Series™                           | QFET®   | TINYOPTO™   |
| CorePOWER™   | Gmax™  | QS™   | TinyPower™  |
| CROSSVOLT™   | GTO™   | Quiet Series™   | TinyPWM™  |
| CTL™   | IntelliMAX™                                    | RapidConfigure™   | TinyWire™   |
| Current Transfer Logic™  | ISOPANAR™                                      |  ™ | TranSiC™  |
| DEUXPEED®  | Making Small Speakers Sound Louder and Better™ | Saving our world, 1mW/W/kW at a time™   | TriFault Detect™  |
| Dual Cool™   | MegaBuck™                                      | SignalWise™   | TRUECURRENT®*   |
| EcoSPARK®  | MICROCOUPLER™                                  | SmartMax™   | µSerDes™  |
| EfficientMax™  | MicroFET™                                      | SMART START™  |  SerDes™         |
| ESBC™  | MicroPak™                                      | Solutions for Your Success™   | UHC®  |
|  Fairchild® | MicroPak2™                                     | SPM®  | Ultra FRFET™  |
| Fairchild Semiconductor®   | MillerDrive™                                   | STEALTH™  | UniFET™   |
| FACT Quiet Series™   | MotionMax™                                     | SuperFET®   | VCX™  |
| FACT®  | MotionGrid®                                    | SuperSOT™-3   | VisualMax™  |
| FAST®  | MTi®   | SuperSOT™-6   | VoltagePlus™  |
| FastvCore™   | MTx®   | SuperSOT™-8   | XS™   |
| FETBench™  | MVN®   | SupreMOS®   | Xsens™  |
| FPS™   | mWSaver®                                       | SyncFET™  | 仙童™   |
|  | OptoHiT™                                       | Sync-Lock™  |   |
|  | OPTOLOGIC®                                     |   |   |

\* Trademarks of System General Corporation, used under license by Fairchild Semiconductor.

### DISCLAIMER

FAIRCHILD SEMICONDUCTOR RESERVES THE RIGHT TO MAKE CHANGES WITHOUT FURTHER NOTICE TO ANY PRODUCTS HEREIN TO IMPROVE RELIABILITY, FUNCTION, OR DESIGN. TO OBTAIN THE LATEST, MOST UP-TO-DATE DATASHEET AND PRODUCT INFORMATION, VISIT OUR WEBSITE AT [HTTP://WWW.FAIRCHILDSEMI.COM](http://www.fairchildsemi.com). FAIRCHILD DOES NOT ASSUME ANY LIABILITY ARISING OUT OF THE APPLICATION OR USE OF ANY PRODUCT OR CIRCUIT DESCRIBED HEREIN; NEITHER DOES IT CONVEY ANY LICENSE UNDER ITS PATENT RIGHTS, NOR THE RIGHTS OF OTHERS. THESE SPECIFICATIONS DO NOT EXPAND THE TERMS OF FAIRCHILD'S WORLDWIDE TERMS AND CONDITIONS, SPECIFICALLY THE WARRANTY THEREIN, WHICH COVERS THESE PRODUCTS.

### LIFE SUPPORT POLICY

FAIRCHILD'S PRODUCTS ARE NOT AUTHORIZED FOR USE AS CRITICAL COMPONENTS IN LIFE SUPPORT DEVICES OR SYSTEMS WITHOUT THE EXPRESS WRITTEN APPROVAL OF FAIRCHILD SEMICONDUCTOR CORPORATION.

As used herein:

1. Life support devices or systems are devices or systems which, (a) are intended for surgical implant into the body or (b) support or sustain life, and (c) whose failure to perform when properly used in accordance with instructions for use provided in the labeling, can be reasonably expected to result in a significant injury of the user.
2. A critical component in any component of a life support, device, or system whose failure to perform can be reasonably expected to cause the failure of the life support device or system, or to affect its safety or effectiveness.

### ANTI-COUNTERFEITING POLICY

Fairchild Semiconductor Corporation's Anti-Counterfeiting Policy. Fairchild's Anti-Counterfeiting Policy is also stated on our external website, [www.fairchildsemi.com](http://www.fairchildsemi.com), under Sales Support.

Counterfeiting of semiconductor parts is a growing problem in the industry. All manufacturers of semiconductor products are experiencing counterfeiting of their parts. Customers who inadvertently purchase counterfeit parts experience many problems such as loss of brand reputation, substandard performance, failed applications, and increased cost of production and manufacturing delays. Fairchild is taking strong measures to protect ourselves and our customers from the proliferation of counterfeit parts. Fairchild strongly encourages customers to purchase Fairchild parts either directly from Fairchild or from Authorized Fairchild Distributors who are listed by country on our web page cited above. Products customers buy either from Fairchild directly or from Authorized Fairchild Distributors are genuine parts, have full traceability, meet Fairchild's quality standards for handling and storage and provide access to Fairchild's full range of up-to-date technical and product information. Fairchild and our Authorized Distributors will stand behind all warranties and will appropriately address any warranty issues that may arise. Fairchild will not provide any warranty coverage or other assistance for parts bought from Unauthorized Sources. Fairchild is committed to combat this global problem and encourage our customers to do their part in stopping this practice by buying direct or from authorized distributors.

### PRODUCT STATUS DEFINITIONS

#### Definition of Terms

| Datasheet Identification | Product Status        | Definition  |
|--------------------------|-----------------------|---|
| Advance Information      | Formative / In Design | Datasheet contains the design specifications for product development. Specifications may change in any manner without notice.   |
| Preliminary              | First Production      | Datasheet contains preliminary data; supplementary data will be published at a later date. Fairchild Semiconductor reserves the right to make changes at any time without notice to improve design. |
| No Identification Needed | Full Production       | Datasheet contains final specifications. Fairchild Semiconductor reserves the right to make changes at any time without notice to improve the design.   |
| Obsolete                 | Not In Production     | Datasheet contains specifications on a product that is discontinued by Fairchild Semiconductor. The datasheet is for reference information only.  |

Rev. I72

# Mouser Electronics

Authorized Distributor

Click to View Pricing, Inventory, Delivery & Lifecycle Information:

[Fairchild Semiconductor:](#)

[MMBT2369A](#)