

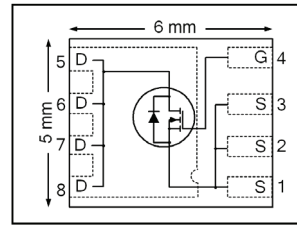
**Application**

- Brushed Motor drive applications
- BLDC Motor drive applications
- Battery powered circuits
- Half-bridge and full-bridge topologies
- Synchronous rectifier applications
- Resonant mode power supplies
- OR-ing and redundant power switches
- DC/DC and AC/DC converters
- DC/AC Inverters

**Benefits**

- Improved Gate, Avalanche and Dynamic dV/dt Ruggedness
- Fully Characterized Capacitance and Avalanche SOA
- Enhanced body diode dV/dt and dI/dt Capability
- Lead-Free, RoHS Compliant

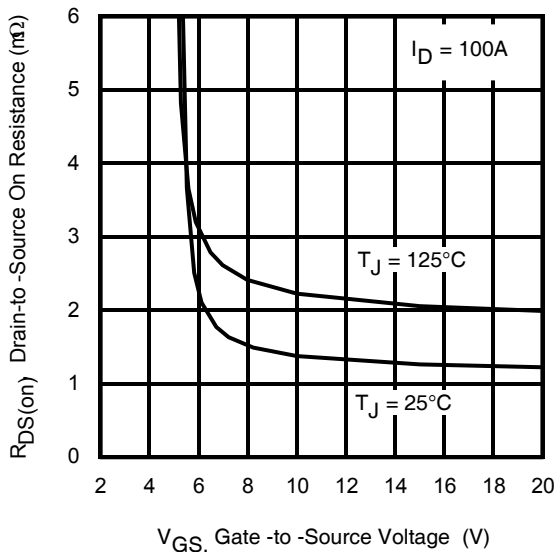
HEXFET® Power MOSFET



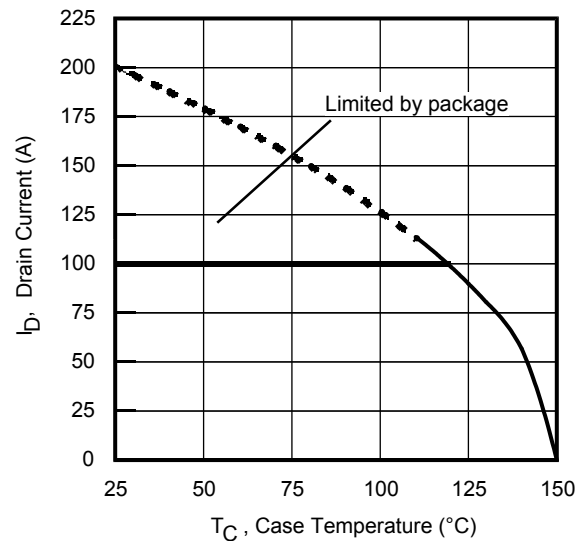
<b>V<sub>DSS</sub></b>	<b>40V</b>
<b>R<sub>DS(on)</sub> typ. max</b>	<b>1.4mΩ</b>
	<b>1.7mΩ</b>
<b>I<sub>D</sub> (Silicon Limited)</b>	<b>201AⓈ</b>
<b>I<sub>D</sub> (Package Limited)</b>	<b>100A</b>



Base part number	Package Type	Standard Pack		Orderable Part Number
		Form	Quantity	
IRF40H210	PQFN 5mm x 6mm	Tape and Reel	4000	IRF40H210



**Fig 1.** Typical On-Resistance vs. Gate Voltage



**Fig 2.** Maximum Drain Current vs. Case Temperature

**Absolute Maximum Rating**

Symbol	Parameter	Max.	Units
$I_D @ T_{C(Bottom)} = 25^\circ\text{C}$	Continuous Drain Current, $V_{GS} @ 10\text{V}$	201①	A
$I_D @ T_{C(Bottom)} = 100^\circ\text{C}$	Continuous Drain Current, $V_{GS} @ 10\text{V}$	127①	
$I_D @ T_{C(Bottom)} = 25^\circ\text{C}$	Continuous Drain Current, $V_{GS} @ 10\text{V}$ (Wire Bond Limited)	100	
$I_{DM}$	Pulsed Drain Current ①	400*	
$P_D @ T_C = 25^\circ\text{C}$	Maximum Power Dissipation	125	W
	Linear Derating Factor	1.0	W/°C
$V_{GS}$	Gate-to-Source Voltage	$\pm 20$	V
$T_J$ $T_{STG}$	Operating Junction and Storage Temperature Range	-55 to + 150	°C

**Avalanche Characteristics**

$E_{AS}$ (Thermally limited)	Single Pulse Avalanche Energy ③	149	mJ
$E_{AS}$ (Thermally limited)	Single Pulse Avalanche Energy ⑩	370	
$I_{AR}$	Avalanche Current ②	See Fig 15, 16, 23a, 23b	A
$E_{AR}$	Repetitive Avalanche Energy ②		mJ

**Thermal Resistance**

Symbol	Parameter	Typ.	Max.	Units
$R_{\theta JC}$ (Bottom)	Junction-to-Case ⑧	—	1.0	°C/W
$R_{\theta JC}$ (Top)	Junction-to-Case ⑧	—	18	
$R_{\theta JA}$	Junction-to-Ambient ⑨	—	33	
$R_{\theta JA} (<10\text{s})$	Junction-to-Ambient ⑨	—	20	

**Static @  $T_J = 25^\circ\text{C}$  (unless otherwise specified)**

Symbol	Parameter	Min.	Typ.	Max.	Units	Conditions
$V_{(BR)DSS}$	Drain-to-Source Breakdown Voltage	40	—	—	V	$V_{GS} = 0\text{V}, I_D = 250\mu\text{A}$
$\Delta V_{(BR)DSS}/\Delta T_J$	Breakdown Voltage Temp. Coefficient	—	42	—	mV/°C	Reference to $25^\circ\text{C}, I_D = 1\text{mA}$ ②
$R_{DS(on)}$	Static Drain-to-Source On-Resistance	—	1.4	1.7	mΩ	$V_{GS} = 10\text{V}, I_D = 100\text{A}$
		—	2.3	—		$V_{GS} = 6.0\text{V}, I_D = 50\text{A}$
$V_{GS(th)}$	Gate Threshold Voltage	2.2	—	3.7	V	$V_{DS} = V_{GS}, I_D = 150\mu\text{A}$
$I_{DSS}$	Drain-to-Source Leakage Current	—	—	1.0	μA	$V_{DS} = 40\text{V}, V_{GS} = 0\text{V}$
		—	—	150		$V_{DS} = 40\text{V}, V_{GS} = 0\text{V}, T_J = 125^\circ\text{C}$
$I_{GSS}$	Gate-to-Source Forward Leakage	—	—	100	nA	$V_{GS} = 20\text{V}$
	Gate-to-Source Reverse Leakage	—	—	-100		$V_{GS} = -20\text{V}$
$R_G$	Gate Resistance	—	2.6	—	Ω	

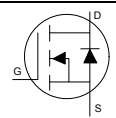
**Notes:**

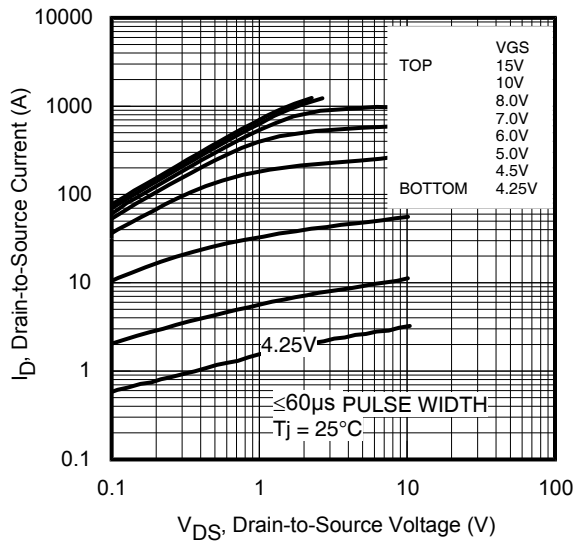
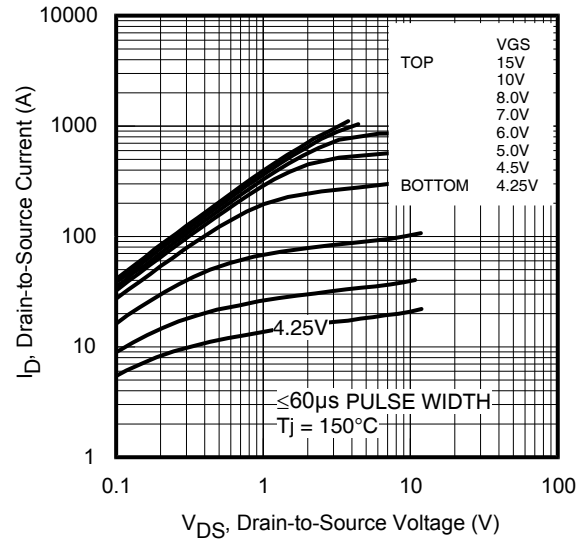
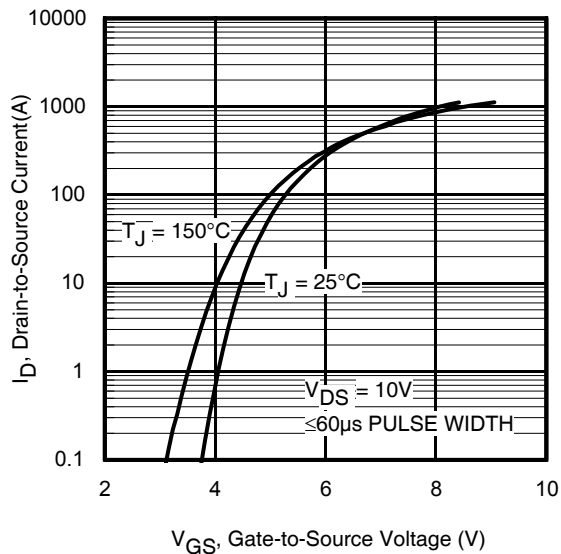
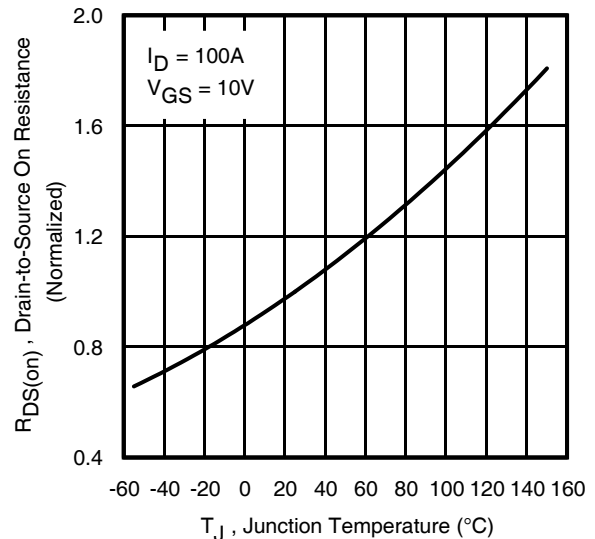
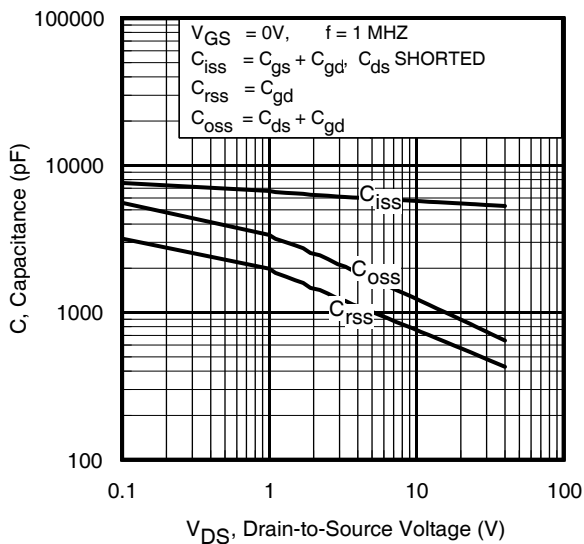
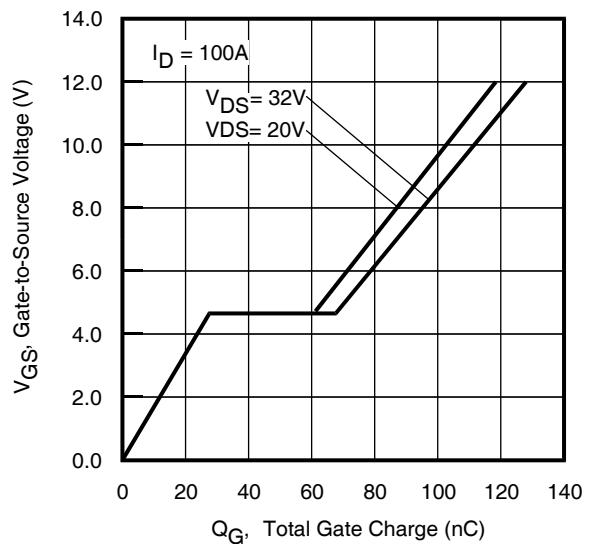
- ① Calculated continuous current based on maximum allowable junction temperature. Bond wire current limit is 100A by source bonding technology. Note that current limitations arising from heating of the device leads may occur with some lead mounting arrangements. (Refer to AN-1140)
  - ② Repetitive rating; pulse width limited by max. junction temperature.
  - ③ Limited by  $T_{Jmax}$ , starting  $T_J = 25^\circ\text{C}$ ,  $L = 0.030\text{mH}$ ,  $R_G = 50\Omega$ ,  $I_{AS} = 100\text{A}$ ,  $V_{GS} = 10\text{V}$ .
  - ④  $I_{SD} \leq 100\text{A}$ ,  $di/dt \leq 1117\text{A}/\mu\text{s}$ ,  $V_{DD} \leq V_{(BR)DSS}$ ,  $T_J \leq 150^\circ\text{C}$ .
  - ⑤ Pulse width  $\leq 400\mu\text{s}$ ; duty cycle  $\leq 2\%$ .
  - ⑥  $C_{oss}$  eff. (TR) is a fixed capacitance that gives the same charging time as  $C_{oss}$  while  $V_{DS}$  is rising from 0 to 80%  $V_{DSS}$ .
  - ⑦  $C_{oss}$  eff. (ER) is a fixed capacitance that gives the same energy as  $C_{oss}$  while  $V_{DS}$  is rising from 0 to 80%  $V_{DSS}$ .
  - ⑧  $R_\theta$  is measured at  $T_J$  approximately  $90^\circ\text{C}$ .
  - ⑨ When mounted on 1 inch square PCB (FR-4). Please refer to AN-994 for more details:  
<http://www.irf.com/technical-info/appnotes/an-994.pdf>
  - ⑩ Limited by  $T_{Jmax}$ , starting  $T_J = 25^\circ\text{C}$ ,  $L = 1\text{mH}$ ,  $R_G = 50\Omega$ ,  $I_{AS} = 27\text{A}$ ,  $V_{GS} = 10\text{V}$ .
- \* Pulse drain current is limited by source bonding technology.

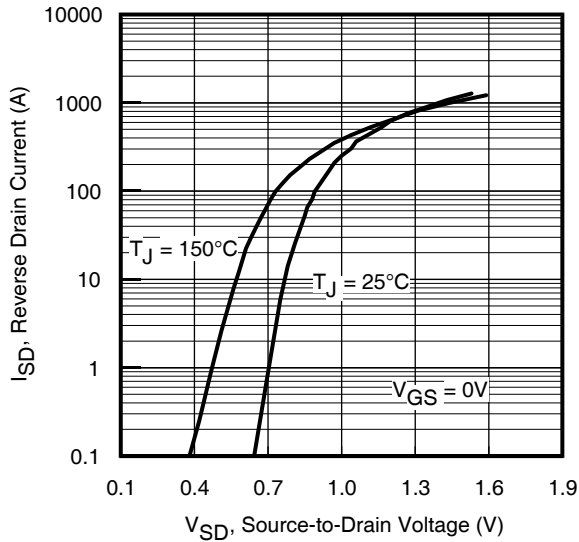
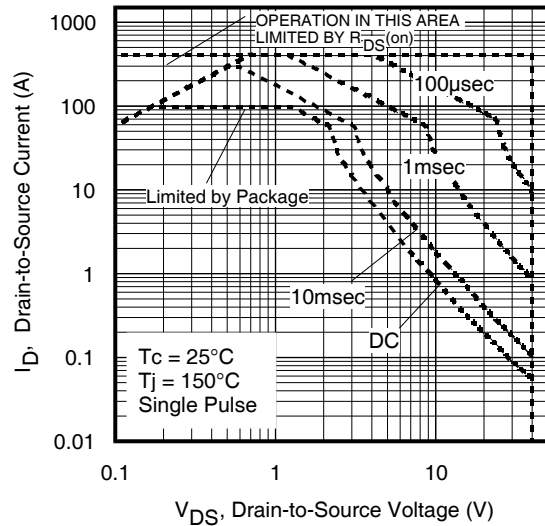
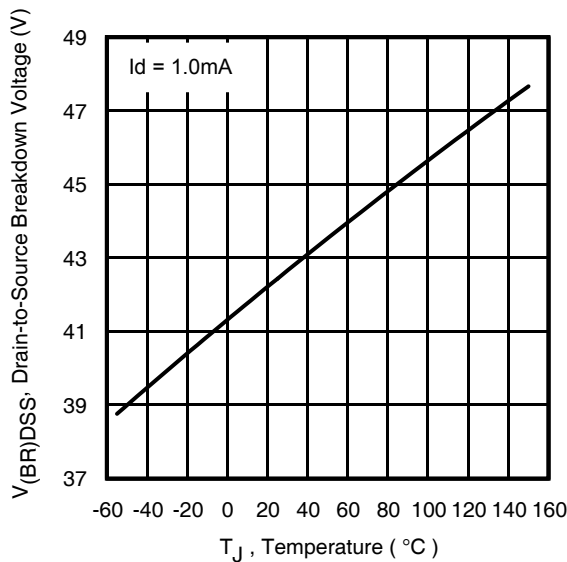
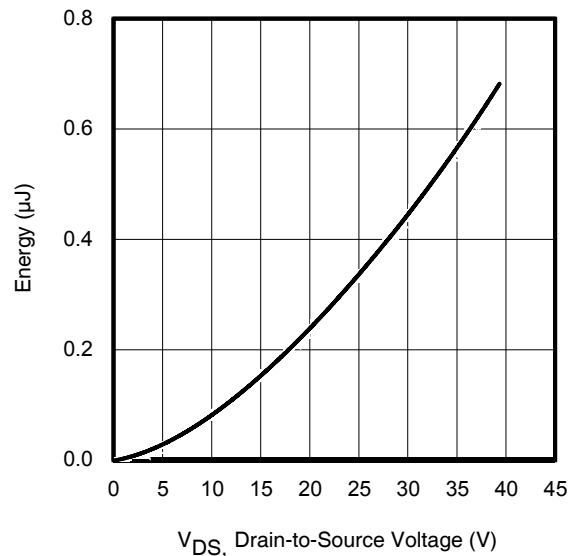
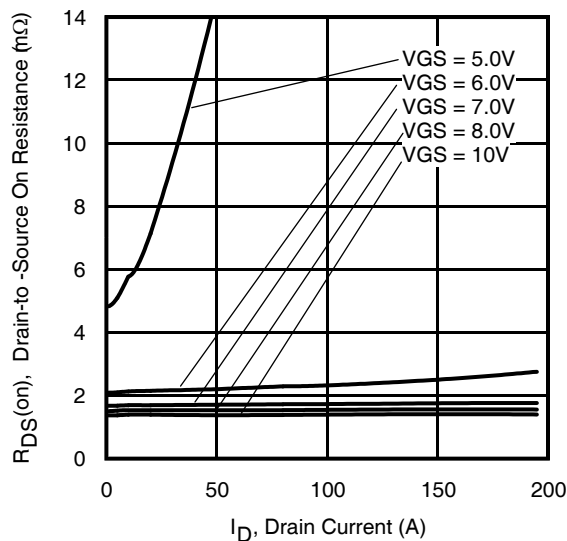
**Dynamic Electrical Characteristics @  $T_J = 25^\circ\text{C}$  (unless otherwise specified)**

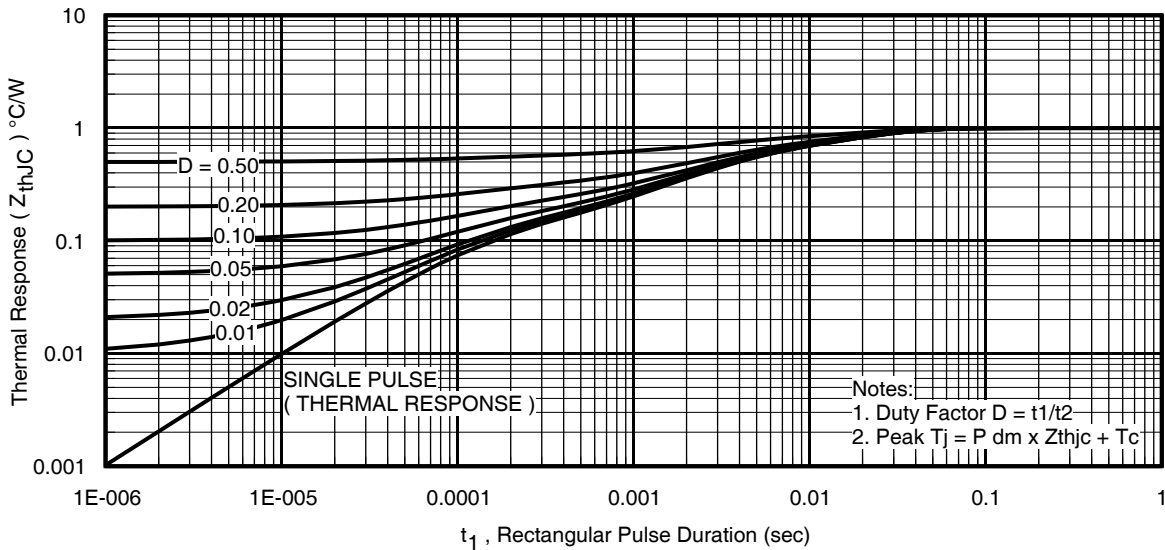
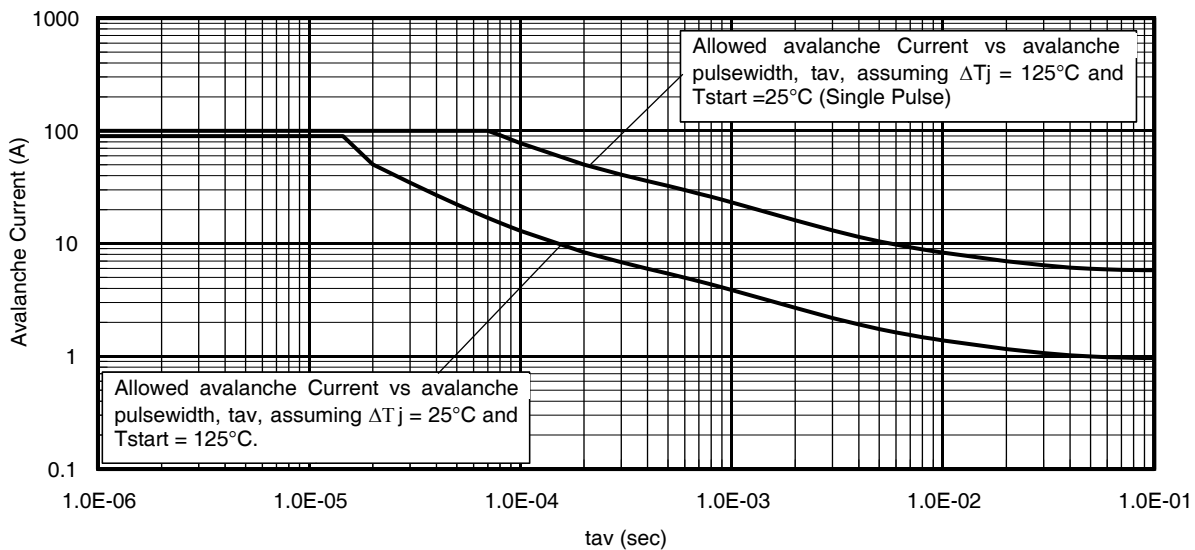
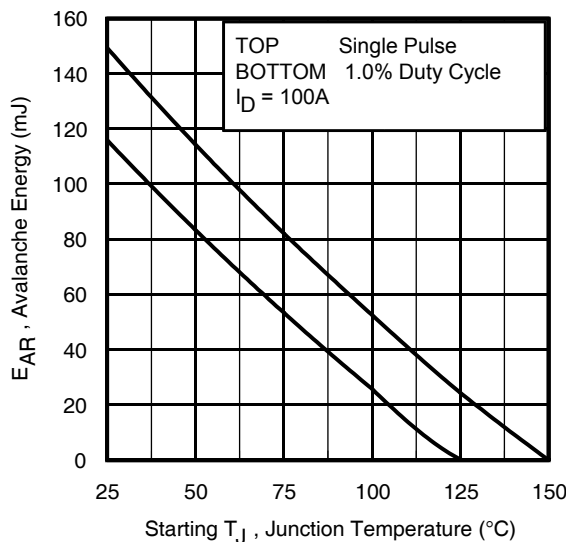
Symbol	Parameter	Min.	Typ.	Max.	Units	Conditions
$g_{fs}$	Forward Transconductance	113	—	—	S	$V_{DS} = 10\text{V}, I_D = 100\text{A}$
$Q_g$	Total Gate Charge	—	101	152	nC	$I_D = 100\text{A}$ $V_{DS} = 20\text{V}$ $V_{GS} = 10\text{V}$
$Q_{gs}$	Gate-to-Source Charge	—	30	—		
$Q_{gd}$	Gate-to-Drain Charge	—	31	—		
$Q_{sync}$	Total Gate Charge Sync. ( $Q_g - Q_{gd}$ )	—	70	—		
$t_{d(on)}$	Turn-On Delay Time	—	9.2	—	ns	$V_{DD} = 20\text{V}$ $I_D = 30\text{A}$ $R_G = 2.7\Omega$ $V_{GS} = 10\text{V}$ ⑤
$t_r$	Rise Time	—	25	—		
$t_{d(off)}$	Turn-Off Delay Time	—	65	—		
$t_f$	Fall Time	—	34	—		
$C_{iss}$	Input Capacitance	—	5406	—	pF	$V_{GS} = 0\text{V}$ $V_{DS} = 25\text{V}$ $f = 1.0\text{MHz}$ , See Fig.7 $V_{GS} = 0\text{V}, V_{DS} = 0\text{V to } 32\text{V}$ ⑦ $V_{GS} = 0\text{V}, V_{DS} = 0\text{V to } 32\text{V}$ ⑥
$C_{oss}$	Output Capacitance	—	805	—		
$C_{riss}$	Reverse Transfer Capacitance	—	518	—		
$C_{oss\ eff.(ER)}$	Effective Output Capacitance (Energy Related)	—	962	—		
$C_{oss\ eff.(TR)}$	Output Capacitance (Time Related)	—	1179	—		

**Diode Characteristics**

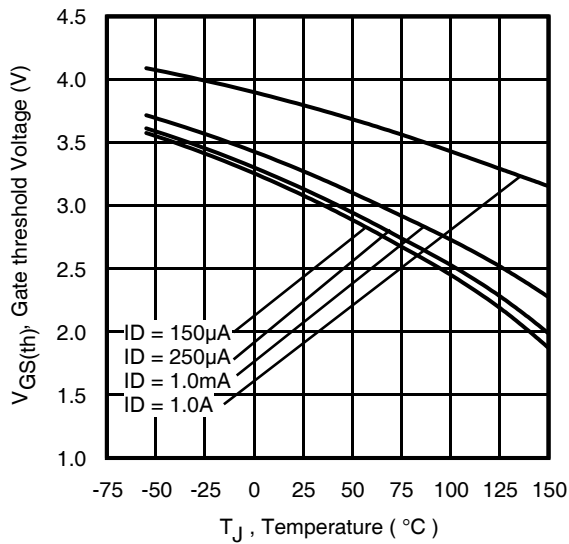
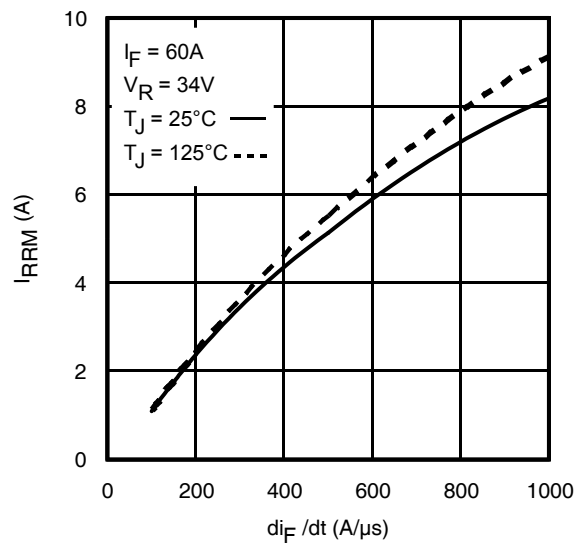
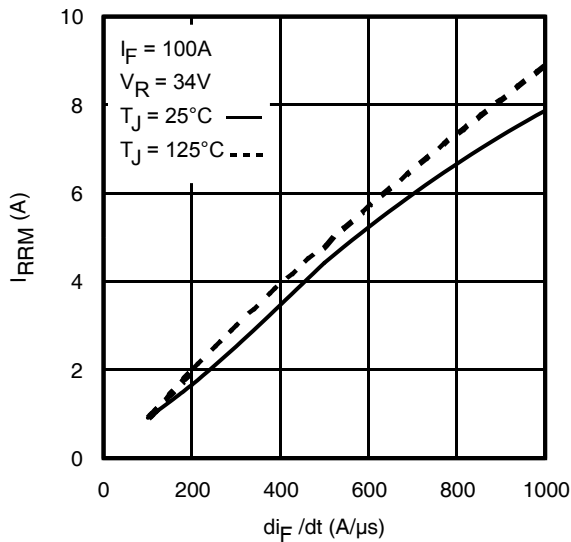
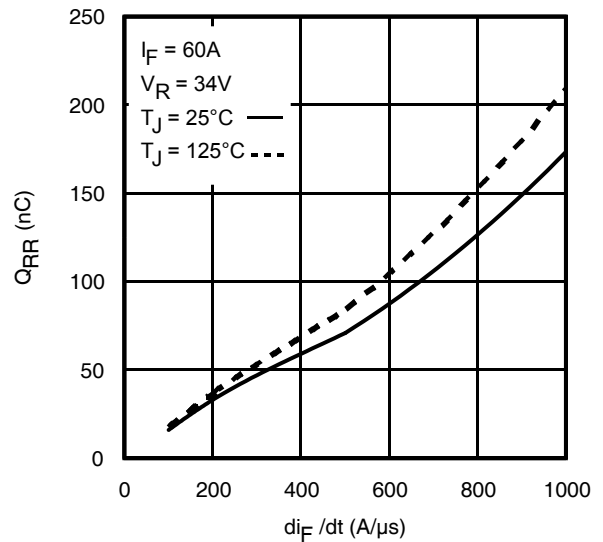
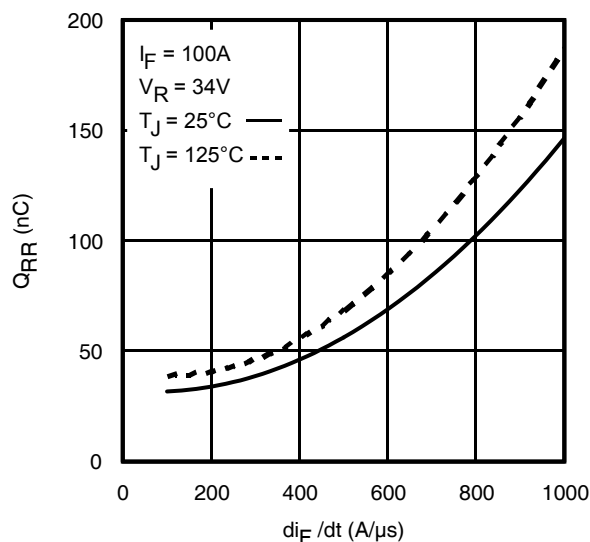
Symbol	Parameter	Min.	Typ.	Max.	Units	Conditions
$I_S$	Continuous Source Current (Body Diode)	—	—	100 ①	A	MOSFET symbol showing the integral reverse p-n junction diode. 
$I_{SM}$	Pulsed Source Current (Body Diode) ①	—	—	400*		
$V_{SD}$	Diode Forward Voltage	—	0.8	1.2	V	$T_J = 25^\circ\text{C}, I_S = 100\text{A}, V_{GS} = 0\text{V}$ ⑤
$dv/dt$	Peak Diode Recovery $dv/dt$ ④	—	6.2	—	V/ns	$T_J = 150^\circ\text{C}, I_S = 100\text{A}, V_{DS} = 40\text{V}$
$t_{rr}$	Reverse Recovery Time	—	21	—	ns	$T_J = 25^\circ\text{C}$ $T_J = 125^\circ\text{C}$ $V_R = 34\text{V}$ $I_F = 100\text{A}$
		—	22	—		
$Q_{rr}$	Reverse Recovery Charge	—	32	—	nC	$T_J = 25^\circ\text{C}$ $T_J = 125^\circ\text{C}$ $di/dt = 100\text{A}/\mu\text{s}$ ⑤
		—	38	—		
$I_{RRM}$	Reverse Recovery Current	—	1.0	—	A	$T_J = 25^\circ\text{C}$

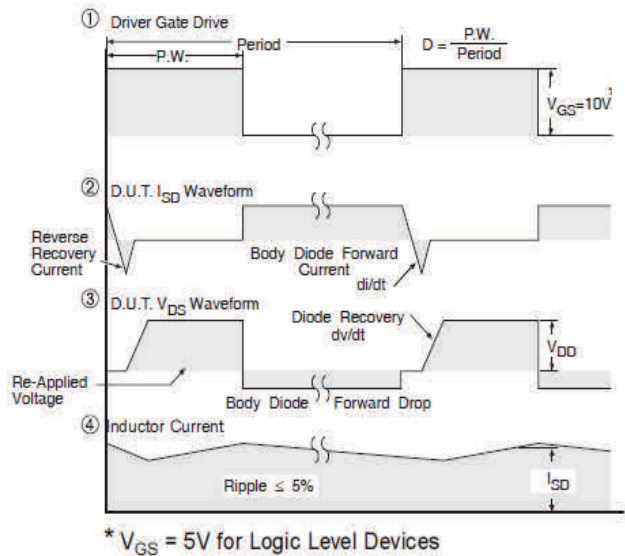
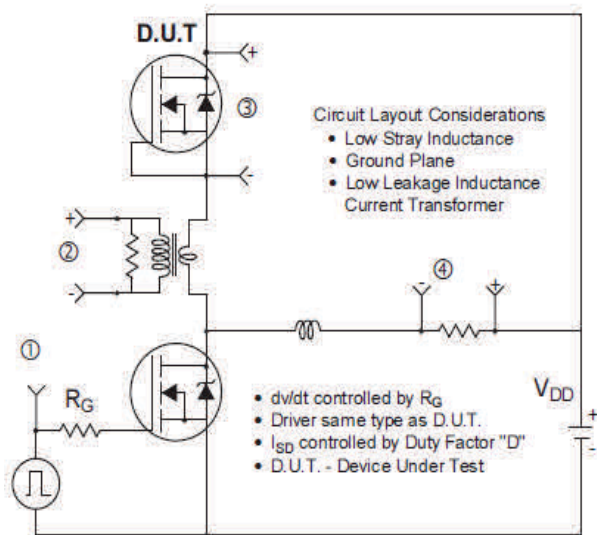
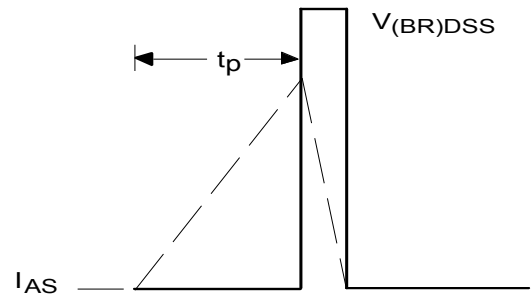
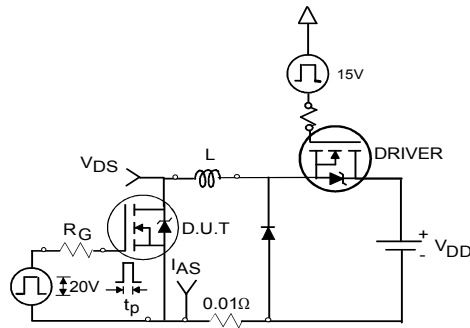
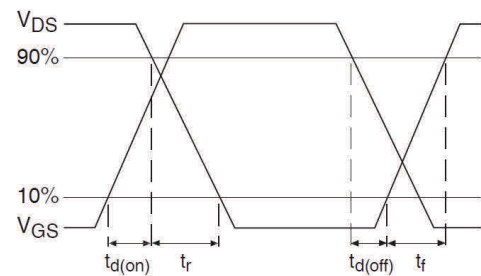
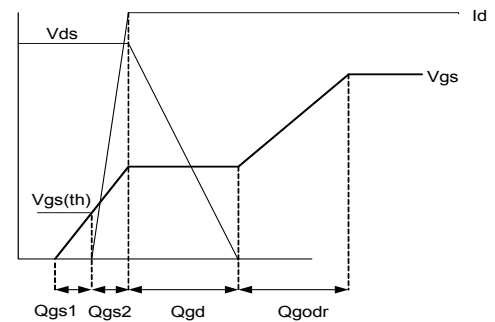
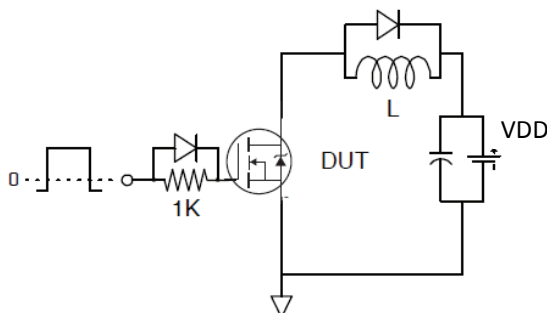

**Fig 3. Typical Output Characteristics**

**Fig 4. Typical Output Characteristics**

**Fig 5. Typical Transfer Characteristics**

**Fig 6. Normalized On-Resistance vs. Temperature**

**Fig 7. Typical Capacitance vs. Drain-to-Source Voltage**

**Fig 8. Typical Gate Charge vs. Gate-to-Source Voltage**


**Fig 9.** Typical Source-Drain Diode Forward Voltage

**Fig 10.** Maximum Safe Operating Area

**Fig 11.** Drain-to-Source Breakdown Voltage

**Fig 12.** Typical  $C_{oss}$  Stored Energy

**Fig 13.** Typical On-Resistance vs. Drain Current

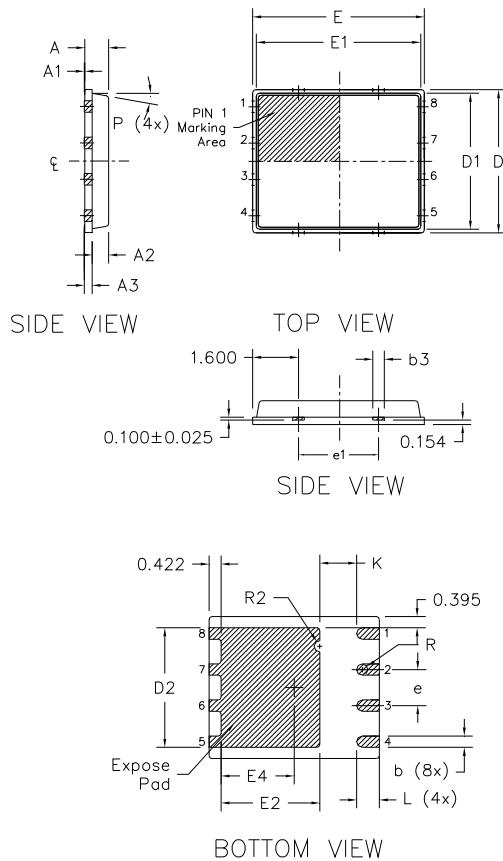

**Fig 14. Maximum Effective Transient Thermal Impedance, Junction-to-Case**

**Fig 15. Avalanche Current vs. Pulse Width**

**Fig 16. Maximum Avalanche Energy vs. Temperature**
**Notes on Repetitive Avalanche Curves , Figures 15, 16:  
(For further info, see AN-1005 at www.irf.com)**

1. Avalanche failures assumption:  
Purely a thermal phenomenon and failure occurs at a temperature far in excess of  $T_{jmax}$ . This is validated for every part type.
2. Safe operation in Avalanche is allowed as long as  $T_{jmax}$  is not exceeded.
3. Equation below based on circuit and waveforms shown in Figures 23a, 23b.
4.  $P_{D(ave)}$  = Average power dissipation per single avalanche pulse.
5. BV = Rated breakdown voltage (1.3 factor accounts for voltage increase during avalanche).
6.  $I_{av}$  = Allowable avalanche current.
7.  $\Delta T$  = Allowable rise in junction temperature, not to exceed  $T_{jmax}$  (assumed as 25°C in Figure 15, 16).  
 $t_{av}$  = Average time in avalanche.  
 $D$  = Duty cycle in avalanche =  $t_{av} \cdot f$   
 $Z_{thJC}(D, t_{av})$  = Transient thermal resistance, see Figures 13)  
 $P_{D(ave)} = 1/2 ( 1.3 \cdot BV \cdot I_{av} ) = \Delta T / Z_{thJC}$   
 $I_{av} = 2\Delta T / [1.3 \cdot BV \cdot Z_{th}]$   
 $E_{AS(AR)} = P_{D(ave)} \cdot t_{av}$


**Fig 17.** Threshold Voltage vs. Temperature

**Fig 18.** Typical Recovery Current vs.  $di/dt$ 

**Fig 19.** Typical Recovery Current vs.  $di/dt$ 

**Fig 20.** Typical Stored Charge vs.  $di/dt$ 

**Fig 21.** Typical Stored Charge vs.  $di/dt$


**Fig 22. Peak Diode Recovery dv/dt Test Circuit for N-Channel HEXFET® Power MOSFETs**

**Fig 23a. Unclamped Inductive Test Circuit**
**Fig 23b. Unclamped Inductive Waveforms**

**Fig 24a. Switching Time Test Circuit**
**Fig 24b. Switching Time Waveforms**

**Fig 25a. Gate Charge Test Circuit**
**Fig 25b. Gate Charge Waveform**



**PQFN 5x6 Outline "B" Package Details**


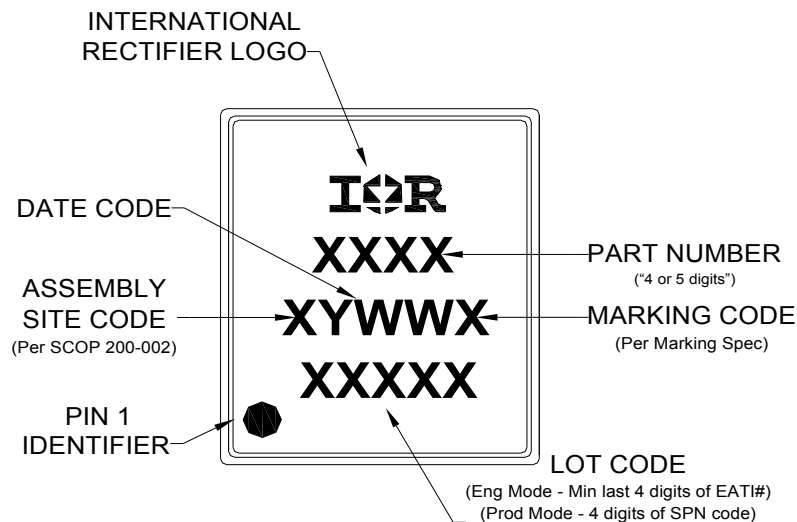
DIM SYMBOL	MILLIMETERS		INCH	
	MIN	MAX	MIN	MAX
A	0.800	0.900	0.0315	0.0543
A1	0.000	0.050	0.0000	0.0020
A3	0.200	REF	0.0079	REF
b	0.350	0.470	0.0138	0.0185
b1	0.025	0.125	0.0010	0.0049
b2	0.210	0.410	0.0083	0.0161
b3	0.150	0.450	0.0059	0.0177
D	5.000 BSC		0.1969 BSC	
D1	4.750 BSC		0.1870 BSC	
D2	4.100	4.300	0.1614	0.1693
E	6.000 BSC		0.2362 BSC	
E1	5.750 BSC		0.2264 BSC	
E2	3.380	3.780	0.1331	0.1488
e	1.270	REF	0.0500	REF
e1	2.800	REF	0.1102	REF
K	1.200	1.420	0.0472	0.0559
L	0.710	0.900	0.0280	0.0354
P	0°	12°	0°	12°
R	0.200	REF	0.0079	REF
R2	0.150	0.200	0.0059	0.0079

**Note:**

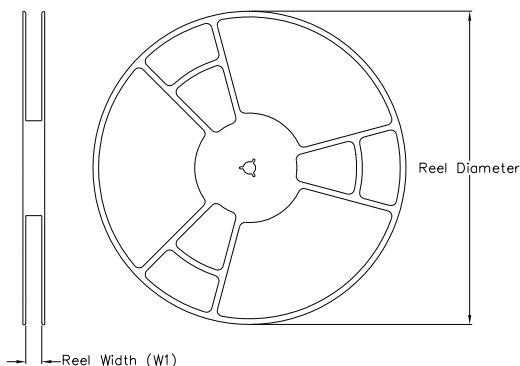
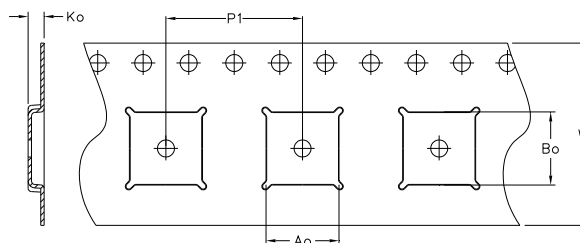
1. Dimensions and tolerancing confirm to ASME Y14.5M-1994
2. Dimension L represents terminal full back from package edge up to 0.1mm is acceptable
3. Coplanarity applies to the expose Heat Slug as well as the terminal
4. Radius on terminal is Optional

For more information on board mounting, including footprint and stencil recommendation, please refer to application note AN-1136: <http://www.irf.com/technical-info/appnotes/an-1136.pdf>

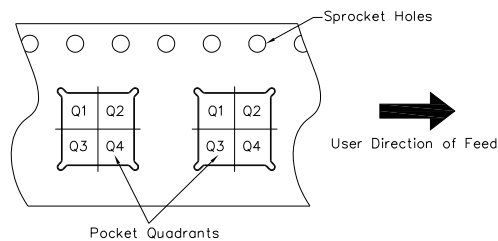
For more information on package inspection techniques, please refer to application note AN-1154: <http://www.irf.com/technical-info/appnotes/an-1154.pdf>

**PQFN 5x6 Part Marking**


Note: For the most current drawing please refer to IR website at <http://www.irf.com/package/>

**PQFN Tape and Reel**
**REEL DIMENSIONS**

**TAPE DIMENSIONS**


CODE	DESCRIPTION
Ao	Dimension design to accommodate the component width
Bo	Dimension design to accommodate the component length
Ko	Dimension design to accommodate the component thickness
W	Overall width of the carrier tape
P1	Pitch between successive cavity centers

**QUADRANT ASSIGNMENTS FOR PIN 1 ORIENTATION IN TAPE**


Note: All dimension are nominal

Package Type	Reel Diameter (Inch)	QTY	Reel Width W1 (mm)	Ao (mm)	Bo (mm)	Ko (mm)	P1 (mm)	W (mm)	Pin 1 Quadrant
5 X 6 PQFN	13	4000	12.4	6.300	5.300	1.20	8.00	12	Q1

Note: For the most current drawing please refer to IR website at <http://www.irf.com/package/>

**Qualification Information<sup>†</sup>**

<b>Qualification Level</b>	Industrial (per JEDEC JESD47F <sup>††</sup> guidelines)	
<b>Moisture Sensitivity Level</b>	PQFN 5mm x 6mm	MSL1 (per JEDEC J-STD-020D <sup>††</sup> )
<b>RoHS Compliant</b>	Yes	

† Qualification standards can be found at International Rectifier's web site: <http://www.irf.com/product-info/reliability>

†† Applicable version of JEDEC standard at the time of product release.

# Mouser Electronics

Authorized Distributor

Click to View Pricing, Inventory, Delivery & Lifecycle Information:

[International Rectifier:](#)

[IRF40H210](#)