

$V_{DS}$	<b>-30</b>	<b>V</b>
$V_{GS\ max}$	<b>±20</b>	<b>V</b>
$R_{DS(on)\ max}$ (@ $V_{GS} = -10V$ )	<b>37</b>	<b>mΩ</b>
$Q_g$ (typical)	<b>13</b>	<b>nC</b>
$I_D$ (@ $T_C = 25^\circ C$ )	<b>-8.5</b> ②	<b>A</b>

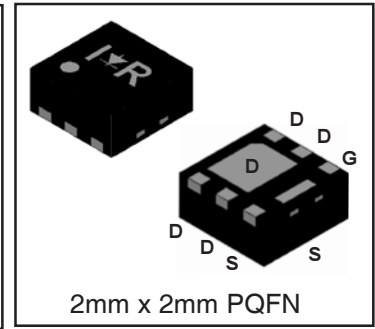
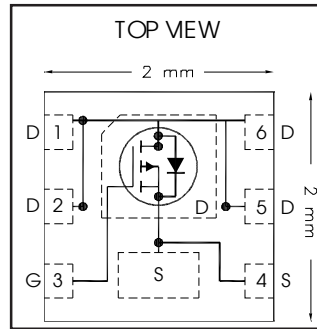

### Applications

- Charge and Discharge Switch for Battery Application
- System/load switch

### Features and Benefits

#### Features

Low $R_{DS(on)}$ ( $\leq 37m\Omega$ )
Low Thermal Resistance to PCB ( $\leq 13^\circ C/W$ )
Low Profile ( $\leq 1.0\ mm$ )
Compatible with Existing Surface Mount Techniques
RoHS Compliant Containing no Lead, no Bromide and no Halogen
MSL1, Industrial Qualification

results in

#### Benefits

Lower Conduction Losses
Enable better thermal dissipation
Increased Power Density
Easier Manufacturing
Environmentally Friendlier
Increased Reliability

Orderable part number	Package Type	Standard Pack		Note
		Form	Quantity	
IRFHS9301TRPBF	PQFN 2mm x 2mm	Tape and Reel	4000	
IRFHS9301TR2PBF	PQFN 2mm x 2mm	Tape and Reel	400	EOL notice # 259

### Absolute Maximum Ratings

	Parameter	Max.	Units
$V_{DS}$	Drain-to-Source Voltage	-30	V
$V_{GS}$	Gate-to-Source Voltage	± 20	
$I_D @ T_A = 25^\circ C$	Continuous Drain Current, $V_{GS} @ -10V$	-6.0	A
$I_D @ T_A = 70^\circ C$	Continuous Drain Current, $V_{GS} @ -10V$	-4.8	
$I_D @ T_C = 25^\circ C$	Continuous Drain Current, $V_{GS} @ -10V$	-13②	
$I_D @ T_C = 70^\circ C$	Continuous Drain Current, $V_{GS} @ -10V$	-10②	
$I_D @ T_C = 25^\circ C$	Continuous Drain Current, $V_{GS} @ 10V$ (Package Limited)	-8.5②	
$I_{DM}$	Pulsed Drain Current ①	-52	
$P_D @ T_A = 25^\circ C$	Power Dissipation ④	2.1	W
$P_D @ T_A = 70^\circ C$	Power Dissipation ④	1.3	
	Linear Derating Factor	0.02	W/°C
$T_J$	Operating Junction and	-55 to + 150	°C
$T_{STG}$	Storage Temperature Range		

Notes ① through ⑤ are on page 2

**Static @  $T_J = 25^\circ\text{C}$  (unless otherwise specified)**

	Parameter	Min.	Typ.	Max.	Units	Conditions
$BV_{DSS}$	Drain-to-Source Breakdown Voltage	-30	—	—	V	$V_{GS} = 0V, I_D = -250\mu A$
$\Delta BV_{DSS}/\Delta T_J$	Breakdown Voltage Temp. Coefficient	—	0.02	—	$V/^\circ\text{C}$	Reference to $25^\circ\text{C}, I_D = -1\text{mA}$
$R_{DS(on)}$	Static Drain-to-Source On-Resistance	—	30	37	m $\Omega$	$V_{GS} = -10V, I_D = -7.8A$ ③
		—	52	65		$V_{GS} = -4.5V, I_D = -6.2A$ ③
$V_{GS(th)}$	Gate Threshold Voltage	-1.3	-1.8	-2.4	V	$V_{DS} = V_{GS}, I_D = -25\mu A$
$\Delta V_{GS(th)}$	Gate Threshold Voltage Coefficient	—	-4.8	—	mV/ $^\circ\text{C}$	
$I_{DSS}$	Drain-to-Source Leakage Current	—	—	-1.0	$\mu A$	$V_{DS} = -24V, V_{GS} = 0V$
		—	—	-150		$V_{DS} = -24V, V_{GS} = 0V, T_J = 125^\circ\text{C}$
$I_{GSS}$	Gate-to-Source Forward Leakage	—	—	-100	nA	$V_{GS} = -20V$
	Gate-to-Source Reverse Leakage	—	—	100		$V_{GS} = 20V$
$g_{fs}$	Forward Transconductance	9.3	—	—	S	$V_{DS} = -10V, I_D = -7.8A$
$Q_g$	Total Gate Charge	—	6.9	—	nC	$V_{DS} = -15V, V_{GS} = -4.5V, I_D = -7.8A$
$Q_g$	Total Gate Charge	—	13	—	nC	$V_{GS} = -10V$
$Q_{gs}$	Gate-to-Source Charge	—	2.1	—		$V_{DS} = -15V$
$Q_{gd}$	Gate-to-Drain Charge	—	3.9	—		$I_D = -7.8A$
$R_G$	Gate Resistance	—	17	—	$\Omega$	
$t_{d(on)}$	Turn-On Delay Time	—	12	—	ns	$V_{DD} = -15V, V_{GS} = -4.5V$ ③
$t_r$	Rise Time	—	80	—		$I_D = -7.8A$
$t_{d(off)}$	Turn-Off Delay Time	—	13	—		$R_G = 2.0\Omega$
$t_f$	Fall Time	—	25	—		See Figs. 19a & 19b
$C_{iss}$	Input Capacitance	—	580	—	pF	$V_{GS} = 0V$
$C_{oss}$	Output Capacitance	—	125	—		$V_{DS} = -25V$
$C_{rss}$	Reverse Transfer Capacitance	—	79	—		$f = 1.0\text{KHz}$

**Diode Characteristics**

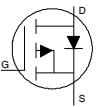
	Parameter	Min.	Typ.	Max.	Units	Conditions
$I_S$	Continuous Source Current (Body Diode)	—	—	-8.5②	A	MOSFET symbol showing the integral reverse p-n junction diode. 
$I_{SM}$	Pulsed Source Current (Body Diode) ①	—	—	-52		
$V_{SD}$	Diode Forward Voltage	—	—	-1.2	V	$T_J = 25^\circ\text{C}, I_S = -7.8A, V_{GS} = 0V$ ③
$t_{rr}$	Reverse Recovery Time	—	30	45	ns	$T_J = 25^\circ\text{C}, I_F = -7.8A, V_{DD} = -15V$
$Q_{rr}$	Reverse Recovery Charge	—	110	170	nC	$di/dt = 280/\mu s$ ③

**Thermal Resistance**

	Parameter	Typ.	Max.	Units
$R_{\theta JC}$ (Bottom)	Junction-to-Case ⑤	—	13	$^\circ\text{C/W}$
$R_{\theta JC}$ (Top)	Junction-to-Case ⑤	—	90	
$R_{\theta JA}$	Junction-to-Ambient ④	—	60	
$R_{\theta JA}$	Junction-to-Ambient ( $t < 10s$ ) ④	—	42	

**Notes:**

- ① Repetitive rating; pulse width limited by max. junction temperature.
- ② Current limited by package.
- ③ Pulse width  $\leq 400\mu s$ ; duty cycle  $\leq 2\%$ .
- ④ When mounted on 1 inch square copper board.
- ⑤  $R_{\theta}$  is measured at  $T_J$  of approximately  $90^\circ\text{C}$ .

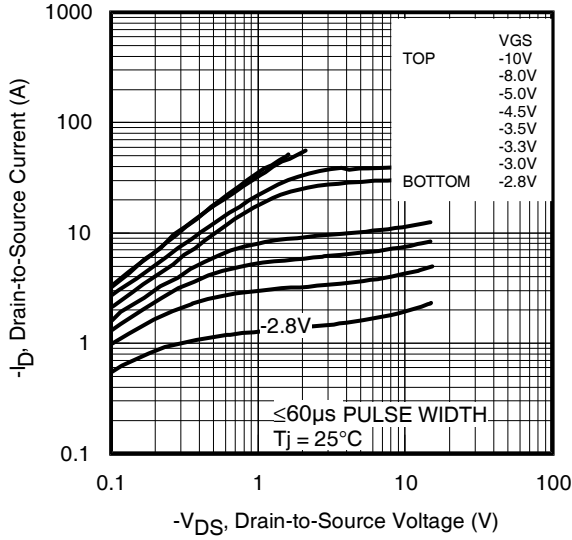
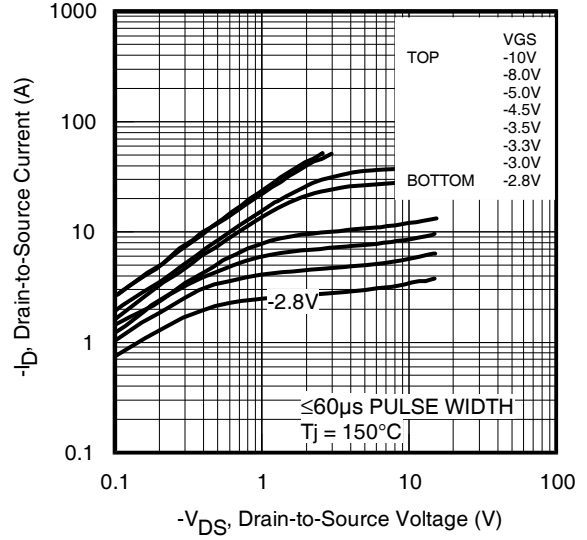
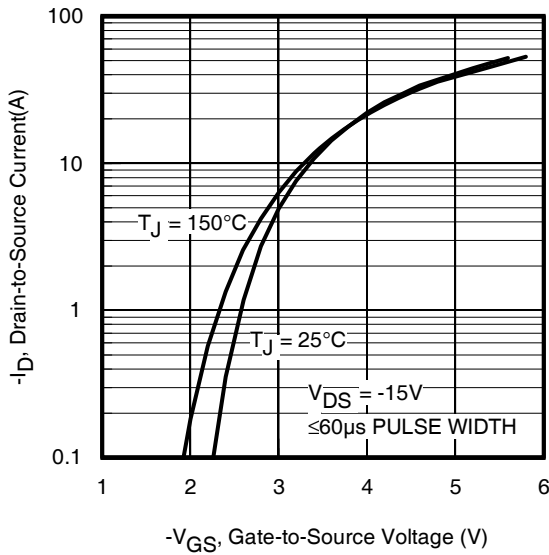
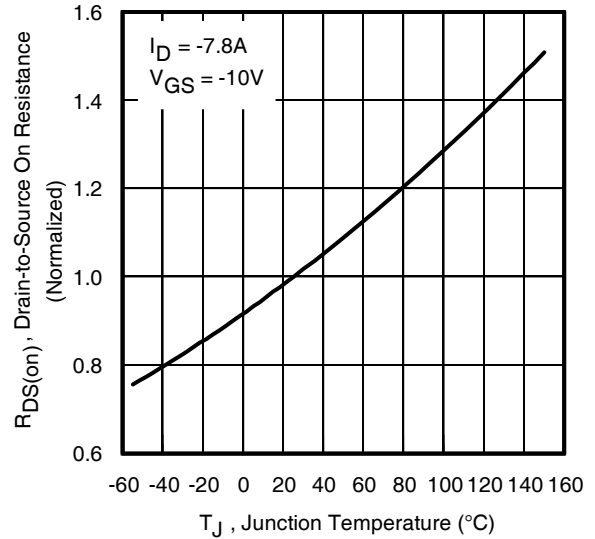
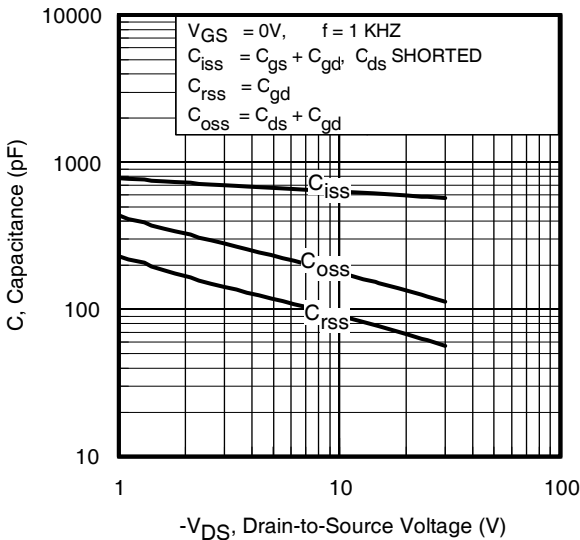
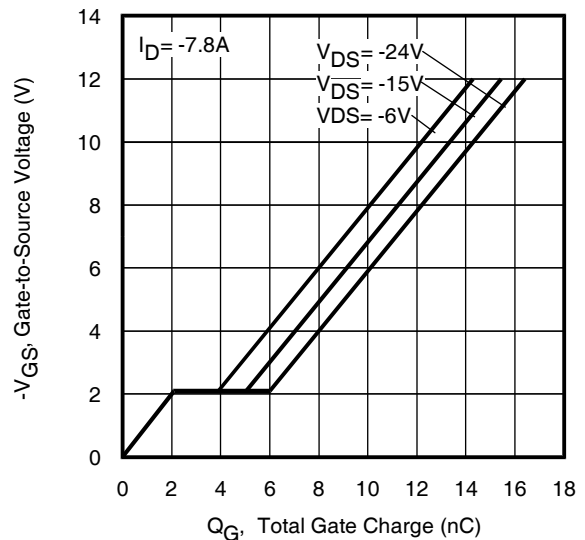
**Fig 1. Typical Output Characteristics**

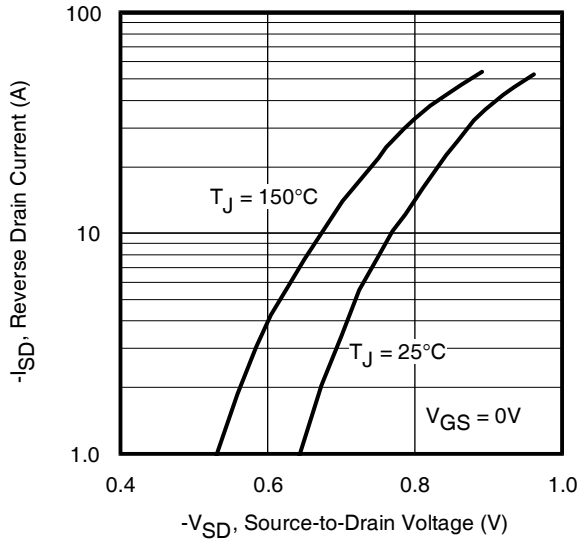
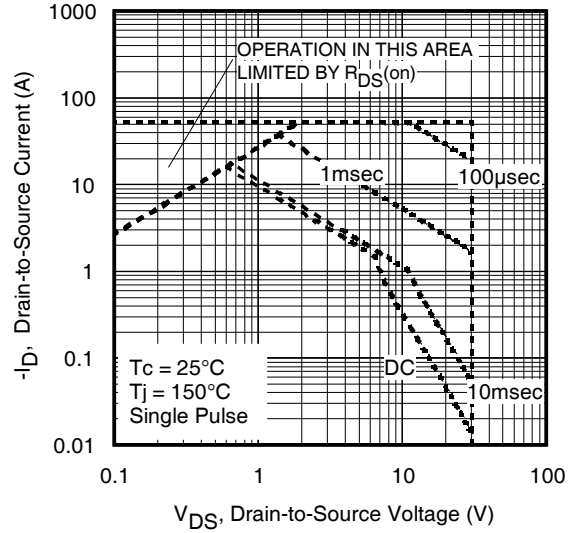
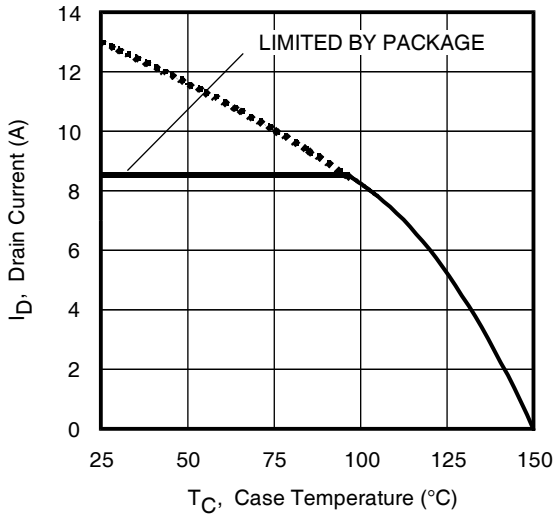
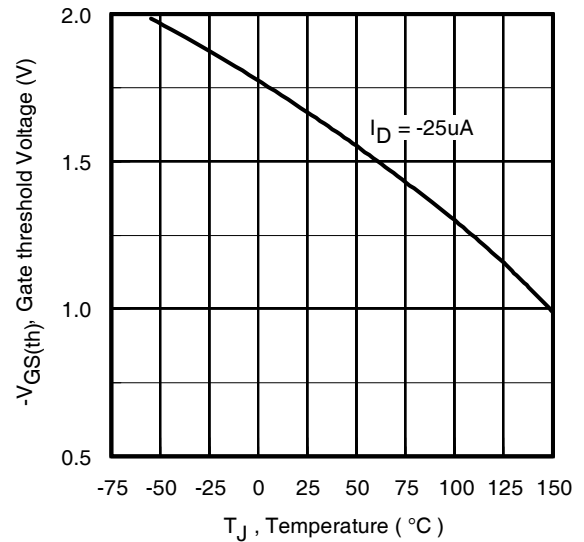
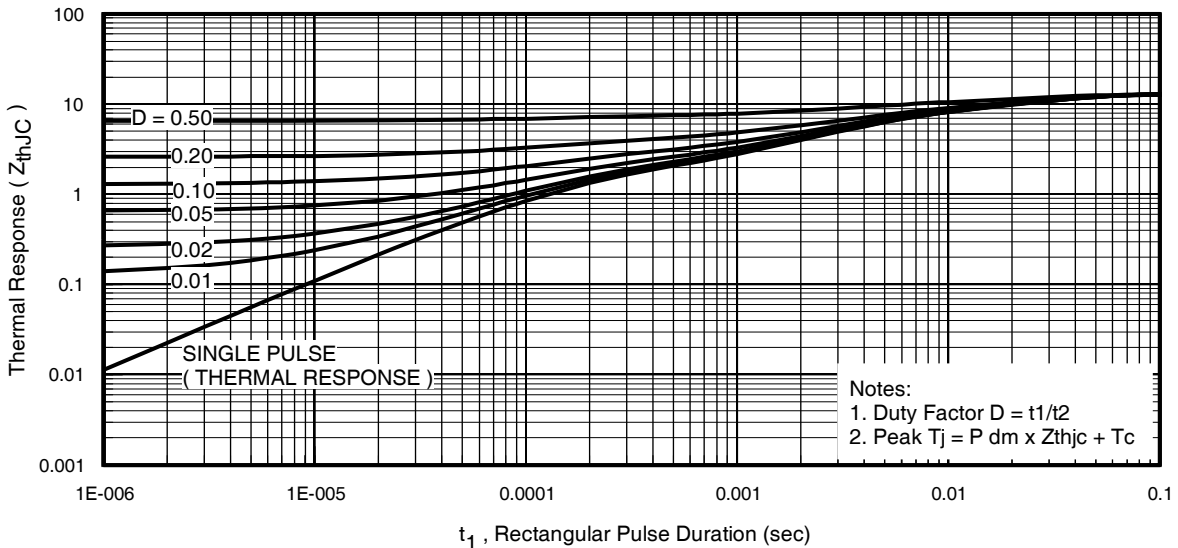
**Fig 2. Typical Output Characteristics**

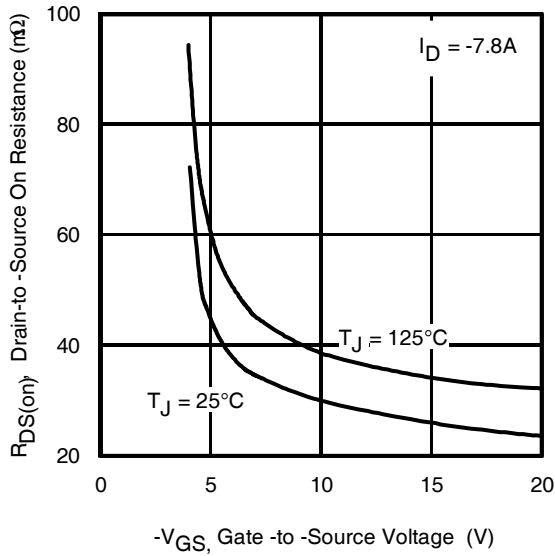
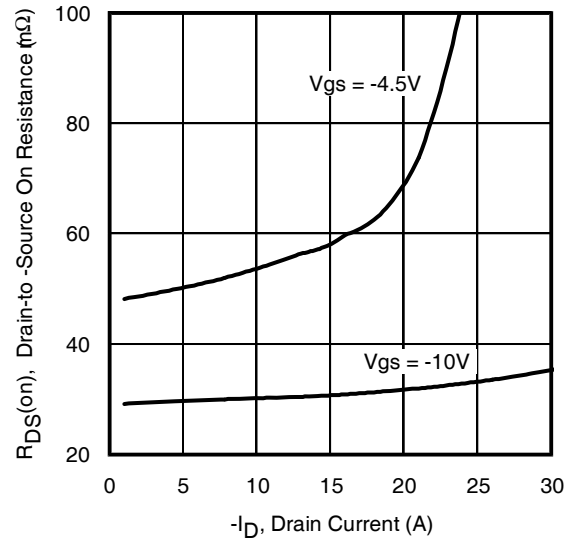
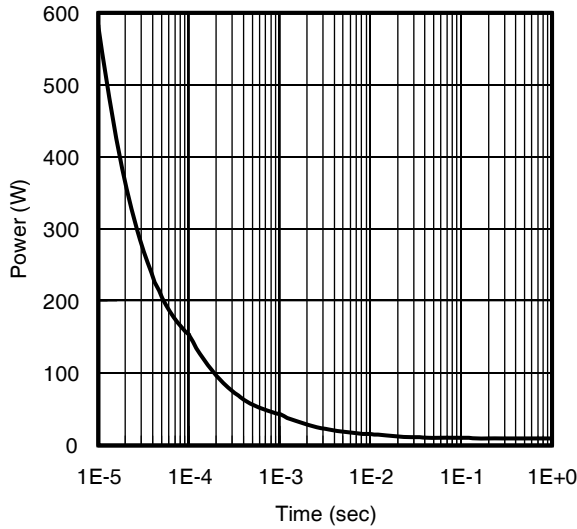
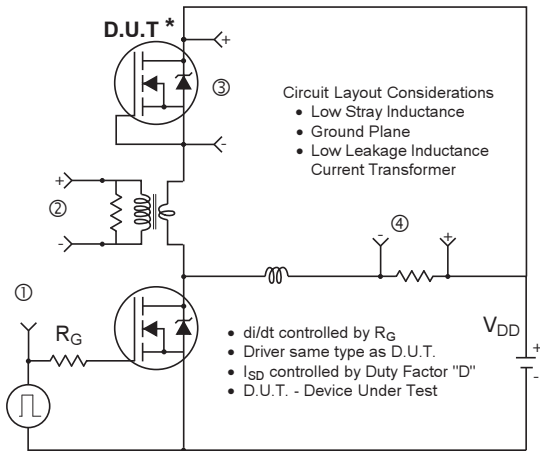
**Fig 3. Typical Transfer Characteristics**

**Fig 4. Normalized On-Resistance vs. Temperature**

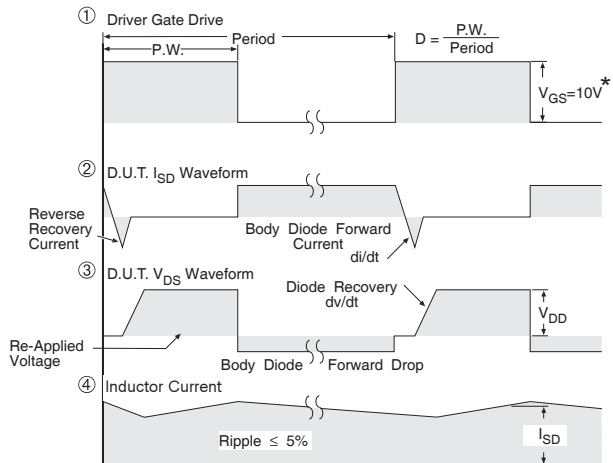
**Fig 5. Typical Capacitance vs. Drain-to-Source Voltage**

**Fig 6. Typical Gate Charge vs. Gate-to-Source Voltage**

**Fig 7.** Typical Source-Drain Diode Forward Voltage

**Fig 8.** Maximum Safe Operating Area

**Fig 9.** Maximum Drain Current vs. Case Temperature

**Fig 10.** Threshold Voltage vs. Temperature

**Fig 11.** Maximum Effective Transient Thermal Impedance, Junction-to-Case

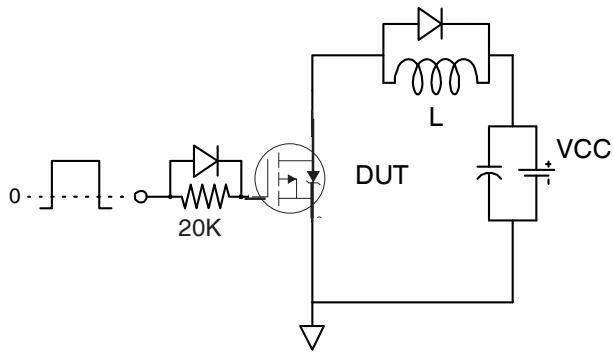
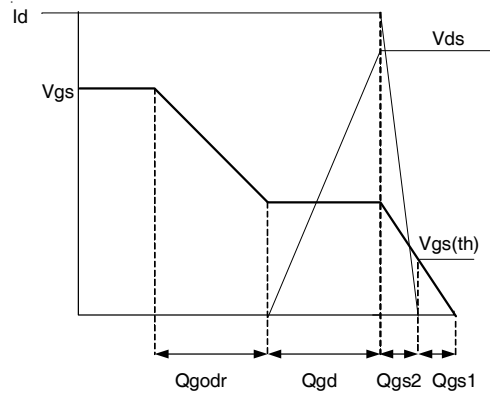
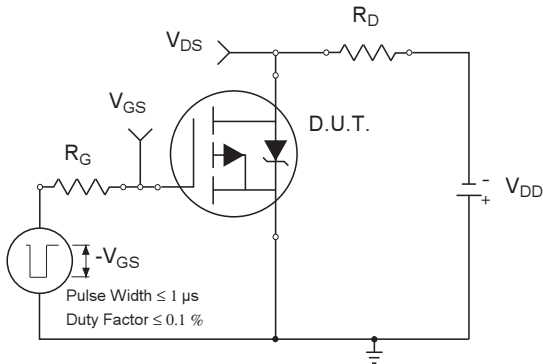
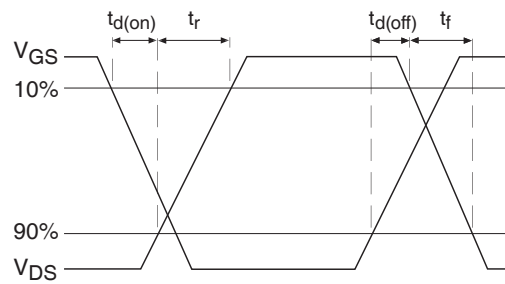

**Fig 12. On-Resistance vs. Gate Voltage**

**Fig 13. Typical On-Resistance vs. Drain Current**

**Fig 14. Typical Power vs. Time**

\* Reverse Polarity of D.U.T for P-Channel



\*  $V_{GS} = 5V$  for Logic Level Devices

**Fig 15. Diode Reverse Recovery Test Circuit for P-Channel HEXFET<sup>®</sup> Power MOSFETs**

**Fig 16a. Gate Charge Test Circuit**

**Fig 16b. Gate Charge Waveform**

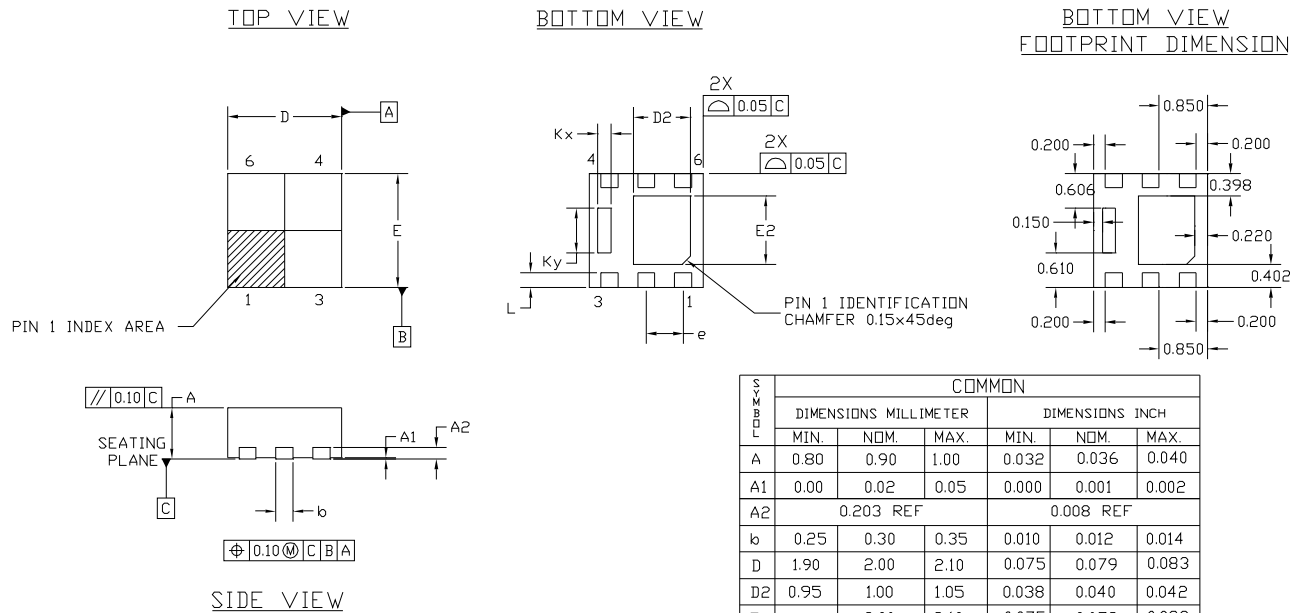
**Fig 17a. Switching Time Test Circuit**

**Fig 17b. Switching Time Waveforms**

## PQFN Package Details



NOTES :

1. DIMENSION AND TOLERANCING CONFORM TO ASME Y14.5M-1994.
2. CONTROLLING DIMENSIONS : MILLIMETER
3. DIMENSION *b* APPLIES TO METALLIZED TERMINAL AND IS MEASURED BETWEEN 0.15 AND 0.30 mm. FROM TERMINAL TIP.

## PQFN Part Marking

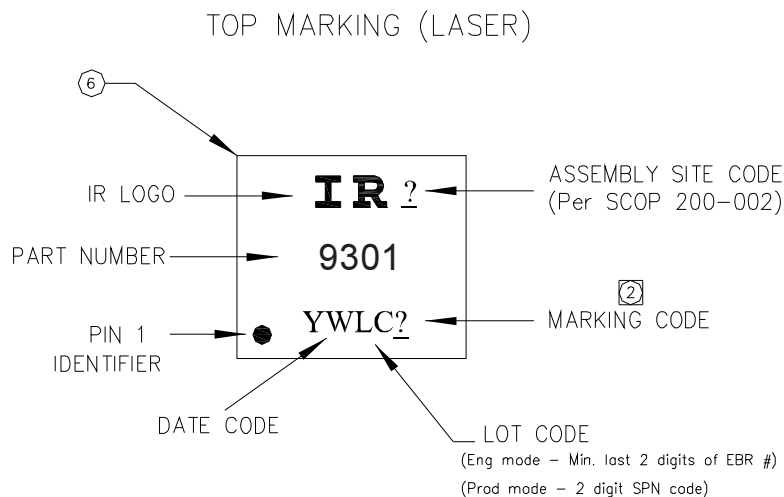

Note: For the most current drawing please refer to IR website at: <http://www.irf.com/package/>

# PQFN Tape and Reel

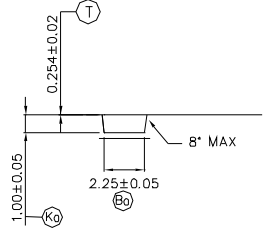
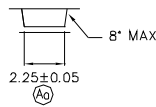
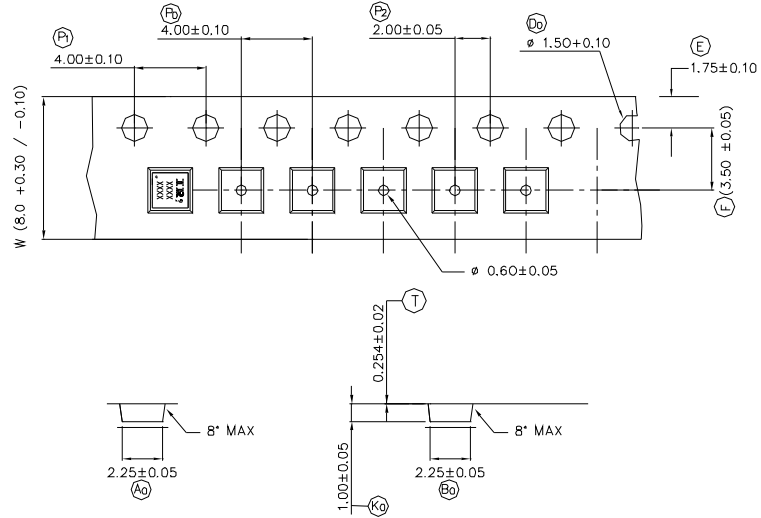

NOTE: The Surface Resistivity is  $10^4 - 10^8$  OHM/SQ

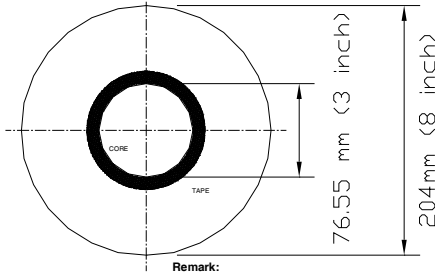
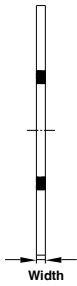

**Remark:**  
 - Dimension above are typical dimensions.  
 - Cover tape thickness is 0.048mm +/- 0.005mm.  
 - Surface resistivity  $10E5 < R_s < 10E9$ .

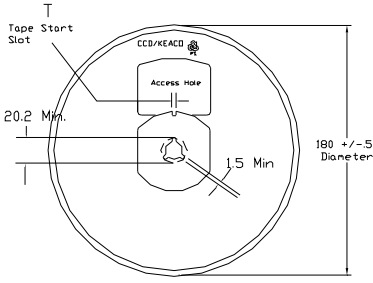

FRONT VIEW

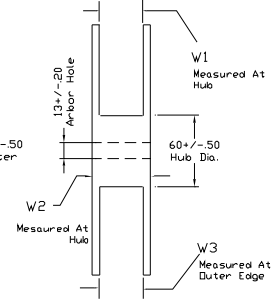

SIDE VIEW

COVER TAPE (WIDTH)	TOLERANCE
5.4 mm	+/- 0.1 mm
9.5 mm	+/- 0.1 mm

TAPE WIDTH	T	W1	W2	W3	PART NO
8 MM	3 ± 0.50	84 <sup>+1.5</sup> <sub>-3.0</sub>	14.4 Max	7.50 Min 10.9 Max	91586-1
12 MM	5 ± 0.50	12.4 <sup>+2.0</sup> <sub>-0.0</sub>	18.4 Max	11.9 Min 15.4 Max	91586-2

Note: Surface resistivity is  $\geq 1 \times 10^5$  but  $< 1 \times 10^{12}$  ohm/sq.

Note: For the most current drawing please refer to IR website at: <http://www.irf.com/package/>



**Qualification information<sup>†</sup>**

Qualification level	Industrial <sup>††</sup> (per JEDEC JESD47F <sup>†††</sup> guidelines )	
Moisture Sensitivity Level	PQFN 2mm x 2mm	MSL1 (per IPC/JEDEC J-STD-020D <sup>†††</sup> )
RoHS compliant	Yes	

† Qualification standards can be found at International Rectifier's web site

<http://www.irf.com/product-info/reliability>

†† Higher qualification ratings may be available should the user have such requirements. Please contact your International Rectifier sales representative for further information:

<http://www.irf.com/whoto-call/salesrep/>

††† Applicable version of JEDEC standard at the time of product release.

**Revision History**

Date	Comment
5/12/2014	<ul style="list-style-type: none"> <li>• Updated ordering information to reflect the End-Of-life (EOL) of the mini-reel option (EOL notice #259)</li> <li>• Updated data sheet based on corporate template.</li> </ul>
5/21/2014	<ul style="list-style-type: none"> <li>• Updated qual level from "Consumer" to "Industrial" on page 1 &amp; 9.</li> </ul>

# Mouser Electronics

Authorized Distributor

Click to View Pricing, Inventory, Delivery & Lifecycle Information:

[International Rectifier:](#)

[IRFHS9301TRPBF](#)