

NPN Silicon Digital Transistor

- Switching circuit, inverter, interface circuit, driver circuit
- Built in bias resistor ($R_1=22k\Omega$, $R_2=22k\Omega$)
- BCR141S : Two internally isolated transistors with good matching in one multichip package
- BCR141S: For orientation in reel see package information below
- Pb-free (RoHS compliant) package
- Qualified according AEC Q101

**BCR141
BCR141W**

BCR141S

Type	Marking	Pin Configuration						Package
		1=B	2=E	3=C	-	-	-	
BCR141	WDs	1=B	2=E	3=C	-	-	-	SOT23
BCR141S	WDs	1=E1	2=B1	3=C2	4=E2	5=B2	6=C1	SOT363
BCR141W	WDs	1=B	2=E	3=C	-	-	-	SOT323

Maximum Ratings

Parameter	Symbol	Value	Unit
Collector-emitter voltage	V_{CEO}	50	V
Collector-base voltage	V_{CBO}	50	
Input forward voltage	$V_{i(fwd)}$	60	
Input reverse voltage	$V_{i(rev)}$	10	
Collector current	I_C	100	mA
Total power dissipation- BCR141, $T_S \leq 118^\circ\text{C}$ BCR141S, $T_S \leq 115^\circ\text{C}$ BCR141W, $T_S \leq 124^\circ\text{C}$	P_{tot}	250 250 250	mW
Junction temperature	T_j	150	°C
Storage temperature	T_{stg}	-65 ... 150	

Thermal Resistance

Parameter	Symbol	Value	Unit
Junction - soldering point ¹⁾	R_{thJS}		K/W
BCR141		≤ 130	
BCR141S		≤ 90	
BCR141W		≤ 140	

¹⁾For calculation of R_{thJA} please refer to Application Note AN077 (Thermal Resistance Calculation)

Electrical Characteristics at $T_A = 25^\circ\text{C}$, unless otherwise specified

Parameter	Symbol	Values			Unit
		min.	typ.	max.	
DC Characteristics					
Collector-emitter breakdown voltage $I_C = 100\ \mu\text{A}, I_B = 0$	$V_{(BR)CEO}$	50	-	-	V
Collector-base breakdown voltage $I_C = 10\ \mu\text{A}, I_E = 0$	$V_{(BR)CBO}$	50	-	-	
Collector-base cutoff current $V_{CB} = 40\ \text{V}, I_E = 0$	I_{CBO}	-	-	100	nA
Emitter-base cutoff current $V_{EB} = 10\ \text{V}, I_C = 0$	I_{EBO}	-	-	350	μA
DC current gain ¹⁾ $I_C = 5\ \text{mA}, V_{CE} = 5\ \text{V}$	h_{FE}	50	-	-	-
Collector-emitter saturation voltage ¹⁾ $I_C = 10\ \text{mA}, I_B = 0.5\ \text{mA}$	V_{CEsat}	-	-	0.3	V
Input off voltage $I_C = 100\ \mu\text{A}, V_{CE} = 5\ \text{V}$	$V_{i(off)}$	0.8	-	1.5	
Input on voltage $I_C = 2\ \text{mA}, V_{CE} = 0.3\ \text{V}$	$V_{i(on)}$	1	-	2.5	
Input resistor	R_1	15	22	29	$\text{k}\Omega$
Resistor ratio	R_1/R_2	0.9	1	1.1	-
AC Characteristics					
Transition frequency $I_C = 10\ \text{mA}, V_{CE} = 5\ \text{V}, f = 100\ \text{MHz}$	f_T	-	130	-	MHz
Collector-base capacitance $V_{CB} = 10\ \text{V}, f = 1\ \text{MHz}$	C_{cb}	-	3	-	pF

¹Pulse test: $t < 300\ \mu\text{s}; D < 2\%$

DC current gain $h_{FE} = f(I_C)$

$V_{CE} = 5\text{ V}$ (common emitter configuration)

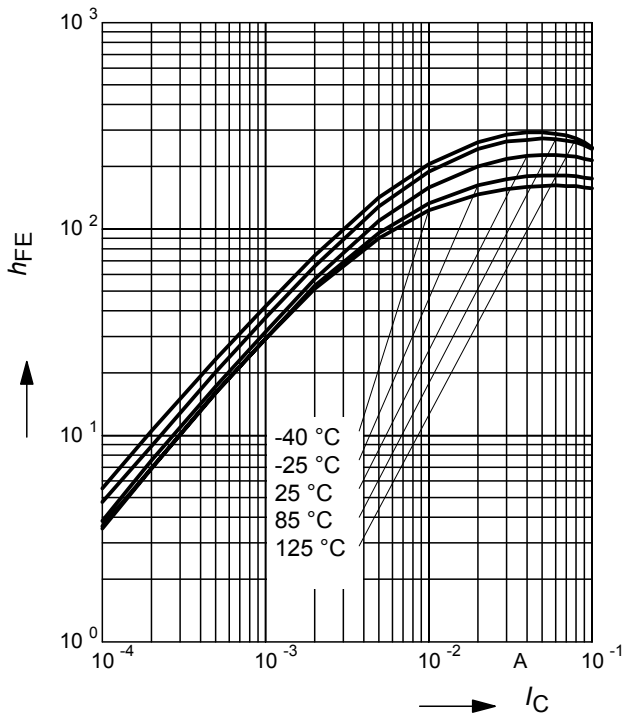

Collector-emitter saturation voltage

$V_{CEsat} = f(I_C), I_C/I_B = 20$

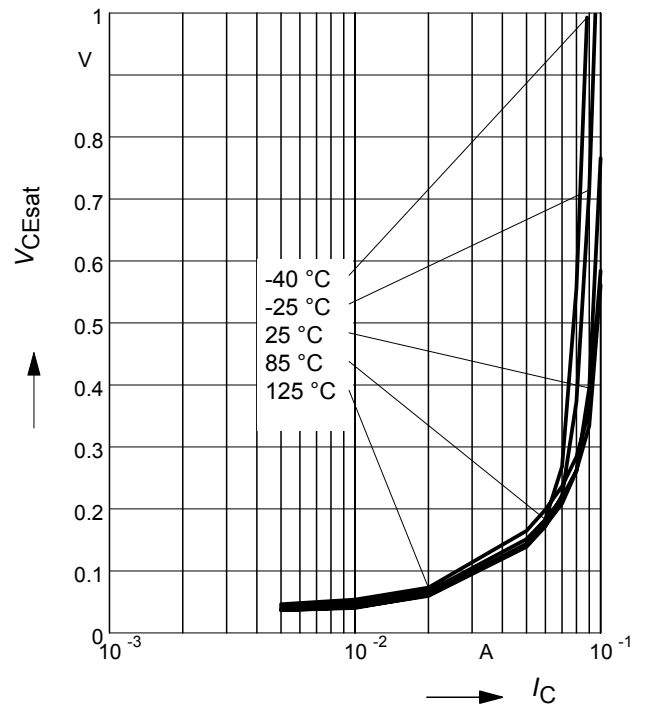

Input on Voltage $V_{i(on)} = f(I_C)$

$V_{CE} = 0.3\text{ V}$ (common emitter voltage)

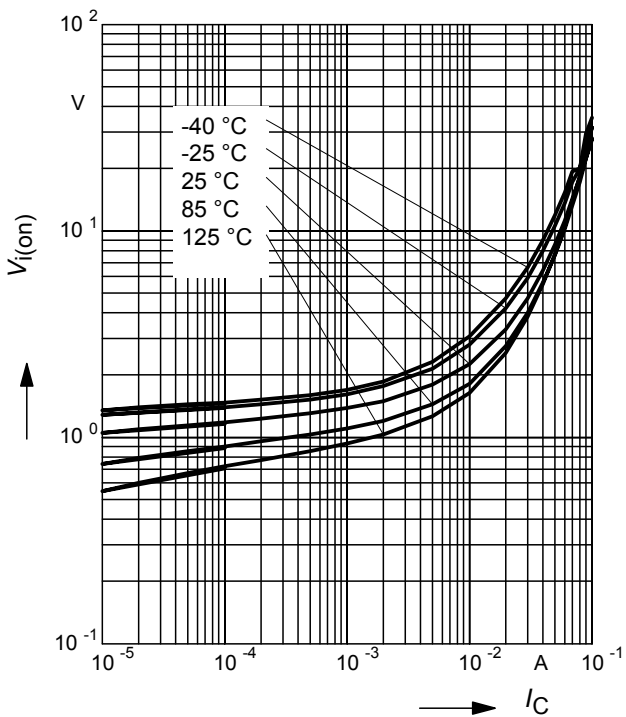

Input off voltage $V_{i(off)} = f(I_C)$

$V_{CE} = 5\text{ V}$ (common emitter voltage)

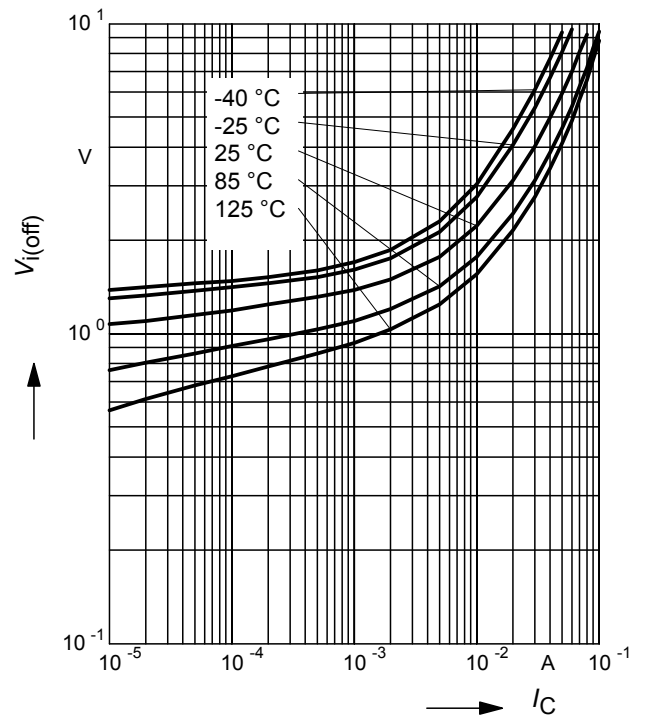

Total power dissipation $P_{tot} = f(T_S)$

BCR141



Total power dissipation $P_{tot} = f(T_S)$

BCR141S

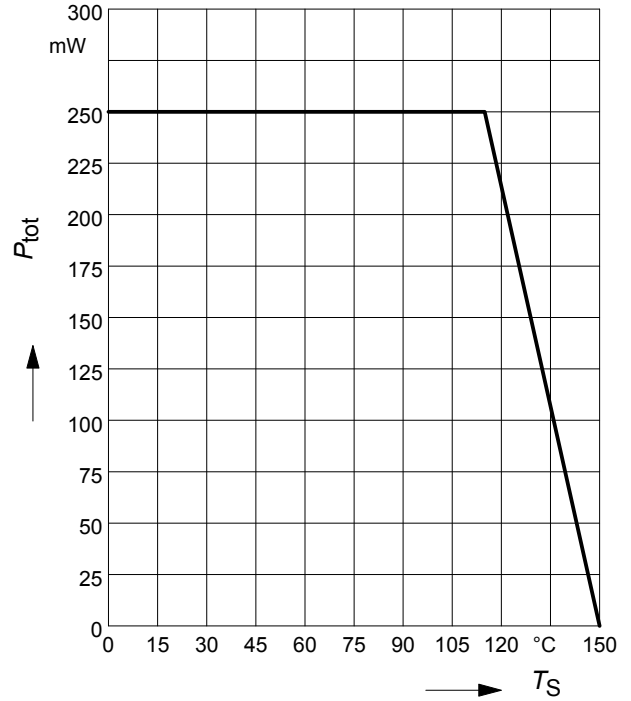

Total power dissipation $P_{tot} = f(T_S)$

BCR141W



Permissible Pulse Load $R_{thJS} = f(t_p)$

BCR141



Permissible Pulse Load

$$P_{\text{totmax}}/P_{\text{totDC}} = f(t_p)$$

BCR141



Permissible Puls Load $R_{\text{thJS}} = f(t_p)$

BCR141S



Permissible Pulse Load

$$P_{\text{totmax}}/P_{\text{totDC}} = f(t_p)$$

BCR141S



Permissible Puls Load $R_{\text{thJS}} = f(t_p)$

BCR141W



Permissible Pulse Load

$$P_{\text{totmax}}/P_{\text{totDC}} = f(t_p)$$

BCR141W



Package Outline



1) Lead width can be 0.6 max. in dambar area

Foot Print



Marking Layout (Example)



Standard Packing

Reel \varnothing 180 mm = 3.000 Pieces/Reel
 Reel \varnothing 330 mm = 10.000 Pieces/Reel



Package Outline

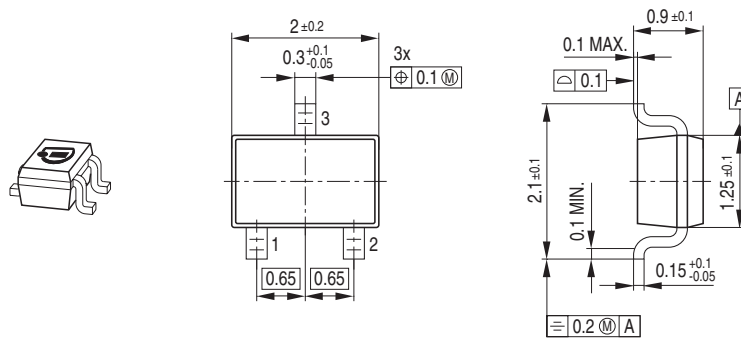

Foot Print



Marking Layout (Example)

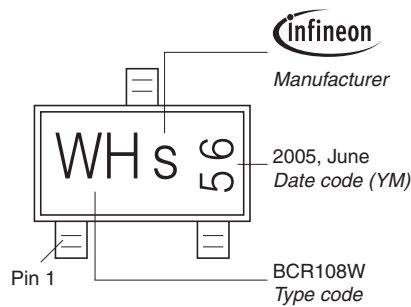

Standard Packing

Reel \varnothing 180 mm = 3.000 Pieces/Reel
 Reel \varnothing 330 mm = 10.000 Pieces/Reel



Package Outline



Foot Print



Marking Layout (Example)

Small variations in positioning of Date code, Type code and Manufacture are possible.



Standard Packing

Reel \varnothing 180 mm = 3.000 Pieces/Reel
 Reel \varnothing 330 mm = 10.000 Pieces/Reel

For symmetric types no defined Pin 1 orientation in reel.

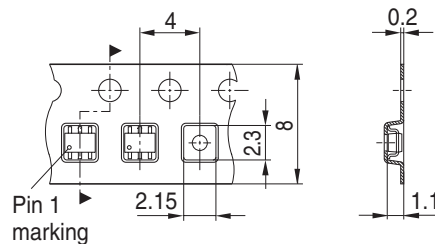

Edition 2009-11-16

**Published by
Infineon Technologies AG
81726 Munich, Germany**

**© 2009 Infineon Technologies AG
All Rights Reserved.**

Legal Disclaimer

The information given in this document shall in no event be regarded as a guarantee of conditions or characteristics. With respect to any examples or hints given herein, any typical values stated herein and/or any information regarding the application of the device, Infineon Technologies hereby disclaims any and all warranties and liabilities of any kind, including without limitation, warranties of non-infringement of intellectual property rights of any third party.

Information

For further information on technology, delivery terms and conditions and prices, please contact the nearest Infineon Technologies Office ([<www.infineon.com>](http://www.infineon.com)).

Warnings

Due to technical requirements, components may contain dangerous substances. For information on the types in question, please contact the nearest Infineon Technologies Office.

Infineon Technologies components may be used in life-support devices or systems only with the express written approval of Infineon Technologies, if a failure of such components can reasonably be expected to cause the failure of that life-support device or system or to affect the safety or effectiveness of that device or system. Life support devices or systems are intended to be implanted in the human body or to support and/or maintain and sustain and/or protect human life. If they fail, it is reasonable to assume that the health of the user or other persons may be endangered.

Mouser Electronics

Authorized Distributor

Click to View Pricing, Inventory, Delivery & Lifecycle Information:

[Infineon:](#)

[BCR141E6327HTSA1](#) [BCR141WH6327XTSA1](#)