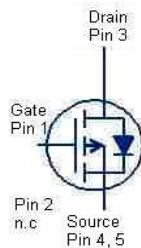
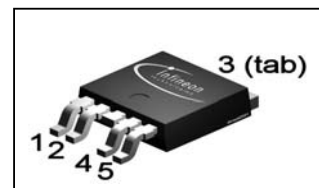

OptiMOS® -P Power-Transistor
Features

- P-Channel
- Enhancement mode
- Logic level
- 175°C operating temperature
- Avalanche rated
- dv/dt rated
- High current rating
- Pb-free lead-plating, RoHS compliant

PG-TO252-5

Type	Package	Marking	Tape and reel information	Lead Free	Packing
SPD50P03L G	PG-TO252-5	50P03L	1000 pcs / reel	Yes	Non dry

Maximum ratings, at $T_j=25\text{ °C}$, unless otherwise specified

Parameter	Symbol	Conditions	Value	Unit
Continuous drain current	I_D	$T_C=25\text{ °C}^{1)}$	-50	A
		$T_C=100\text{ °C}^{1)}$	-50	
Pulsed drain current	$I_{D,pulse}$	$T_C=25\text{ °C}$	-200	
Avalanche energy, single pulse	E_{AS}	$I_D=-50\text{ A}$, $R_{GS}=25\ \Omega$	256	mJ
Reverse diode dv/dt	dv/dt	$I_D=-50\text{ A}$, $V_{DS}=24\text{ V}$, $di/dt=-200\text{ A}/\mu\text{s}$, $T_{j,max}=175\text{ °C}$	-6	kV/ μs
Gate source voltage	V_{GS}		± 20	V
Power dissipation	P_{tot}	$T_C=25\text{ °C}$	150	W
Operating and storage temperature	T_j , T_{stg}		-55...+175	°C
ESD class HBM			1C	
Soldering temperature			260	
IEC climatic category; DIN IEC 68-1			55/175/56	

Parameter	Symbol	Conditions	Values			Unit
			min.	typ.	max.	

Thermal characteristics

Thermal resistance, junction - case	R_{thJC}		-	-	1	K/W
Thermal resistance, junction - ambient	R_{thJA}	minimal footprint	-	-	75	
		6 cm ² cooling area ²⁾	-	-	50	

Electrical characteristics, at $T_j=25\text{ }^\circ\text{C}$, unless otherwise specified
Static characteristics

Drain-source breakdown voltage	$V_{(BR)DSS}$	$V_{GS}=0\text{ V}, I_D=-250\text{ }\mu\text{A}$	-30	-	-	V
Gate threshold voltage	$V_{GS(th)}$	$V_{DS}=V_{GS}, I_D=-250\text{ }\mu\text{A}$	-1	-1.5	-2	
Zero gate voltage drain current	I_{DSS}	$V_{DS}=-30\text{ V}, V_{GS}=0\text{ V}, T_j=25\text{ }^\circ\text{C}$	-	-0.1	-1	μA
		$V_{DS}=-30\text{ V}, V_{GS}=0\text{ V}, T_j=175\text{ }^\circ\text{C}$	-	-10	-100	
Gate-source leakage current	I_{GSS}	$V_{GS}=-20\text{ V}, V_{DS}=0\text{ V}$	-	-10	-100	nA
Drain-source on-state resistance	$R_{DS(on)}$	$V_{GS}=-4.5\text{ V}, I_D=-30\text{ A}$	-	8.5	12.5	m Ω
Drain-source on-state resistance	$R_{DS(on)}$	$V_{GS}=-10\text{ V}, I_D=-50\text{ A}$	-	5.7	7.0	
Transconductance	g_{fs}	$ V_{DS} >2 I_D R_{DS(on)max}, I_D=-50\text{ A}$	47	94	-	S

¹⁾ Current is limited by bondwire; with an $R_{thJC}=1\text{ K/W}$ the chip is able to carry 123 A.

²⁾ Device on 40 mm x 40 mm x 1.5 mm epoxy PCB FR4 with 6 cm² (one layer, 70 μm thick) copper area for drain connection. PCB is vertical in still air.

Parameter	Symbol	Conditions	Values			Unit
			min.	typ.	max.	

Dynamic characteristics

Input capacitance	C_{iss}	$V_{GS}=0\text{ V},$ $V_{DS}=-25\text{ V}, f=1\text{ MHz}$	-	4590	6880	pF
Output capacitance	C_{oss}		-	1220	1830	
Reverse transfer capacitance	C_{rss}		-	1000	1500	
Turn-on delay time	$t_{d(on)}$	$V_{DD}=-15\text{ V},$ $V_{GS}=-10\text{ V}, I_D=-1\text{ A},$ $R_G=6\ \Omega$	-	14.8	22	ns
Rise time	t_r		-	21.7	32	
Turn-off delay time	$t_{d(off)}$		-	139	208	
Fall time	t_f		-	104	156	

Gate Charge Characteristics³⁾

Gate to source charge	Q_{gs}	$V_{DD}=-24\text{ V}, I_D=-50\text{ A}$	-	-14	-19	nC
Gate to drain charge	Q_{gd}		-	-35	-53	
Gate charge total	Q_g	$V_{DD}=-24\text{ V}, I_D=-50\text{ A},$ $V_{GS}=0\text{ to }-10\text{ V}$	-	-95	-126	
Gate plateau voltage	$V_{plateau}$	$V_{DD}=-24\text{ V}, I_D=-50\text{ A}$	-	-3.0	-	V

Reverse Diode

Diode continuous forward current	I_S	$T_C=25\text{ }^\circ\text{C}$	-	-	-50	A
Diode pulse current	$I_{S,pulse}$		-	-	-200	
Diode forward voltage	V_{SD}	$V_{GS}=0\text{ V}, I_F=50\text{ A},$ $T_j=25\text{ }^\circ\text{C}$	-	-1	-1.65	V
Reverse recovery time	t_{rr}	$V_R=-15\text{ V}, I_F= I_S ,$ $di_F/dt=100\text{ A}/\mu\text{s}$	-	38	47	ns
Reverse recovery charge	Q_{rr}		-	46	57	nC

³⁾ See figure 16 for gate charge parameter definition

1 Power dissipation

$$P_{tot} = f(T_C)$$

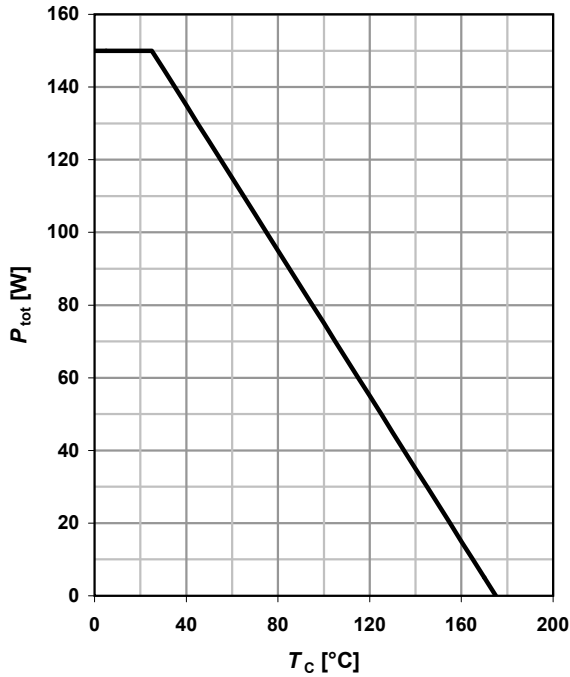

2 Drain current

$$I_D = f(T_C); |V_{GS}| \geq 10 \text{ V}$$

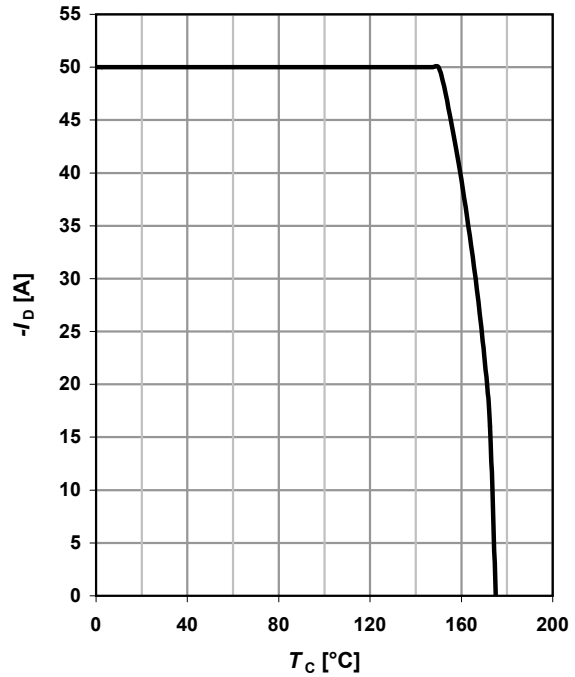

3 Safe operating area

$$I_D = f(V_{DS}); T_C = 25 \text{ °C}; D = 0$$

parameter: t_p

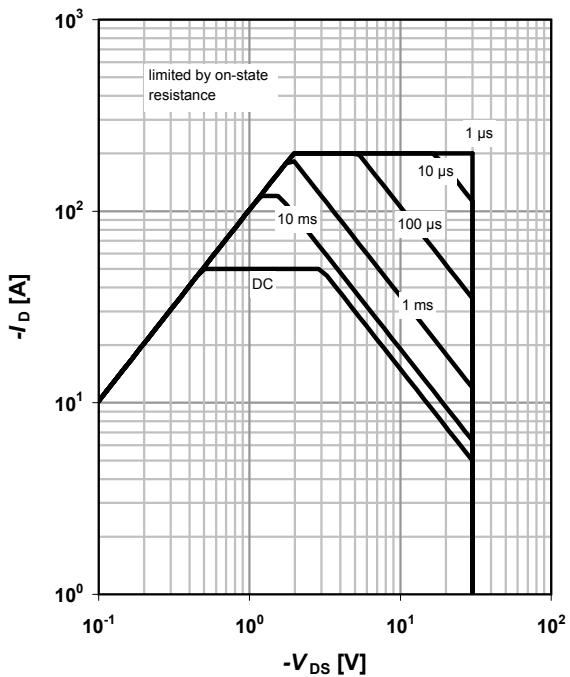

4 Max. transient thermal impedance

$$Z_{thJC} = f(t_p)$$

parameter: $D = t_p / T$

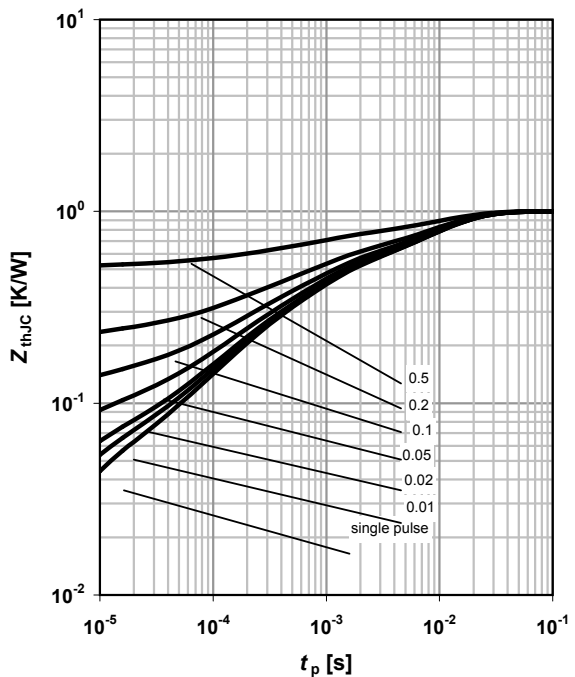

5 Typ. output characteristics

$I_D = f(V_{DS}); T_j = 25\text{ }^\circ\text{C}$

parameter: V_{GS}

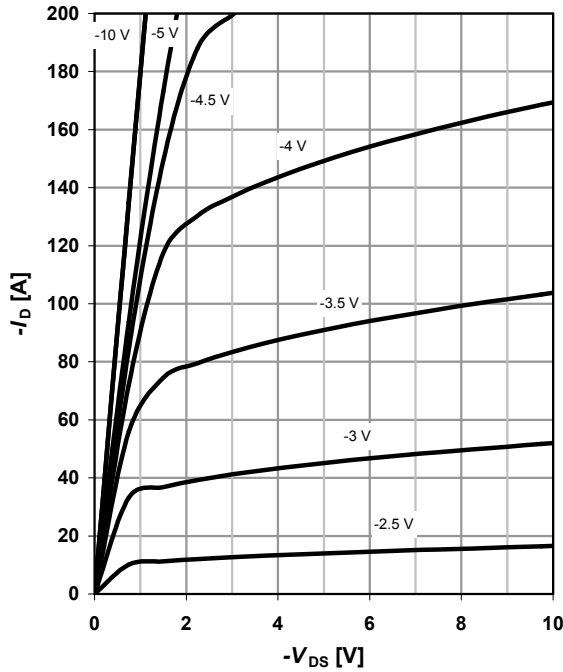

6 Typ. drain-source on resistance

$R_{DS(on)} = f(I_D); T_j = 25\text{ }^\circ\text{C}$

parameter: V_{GS}

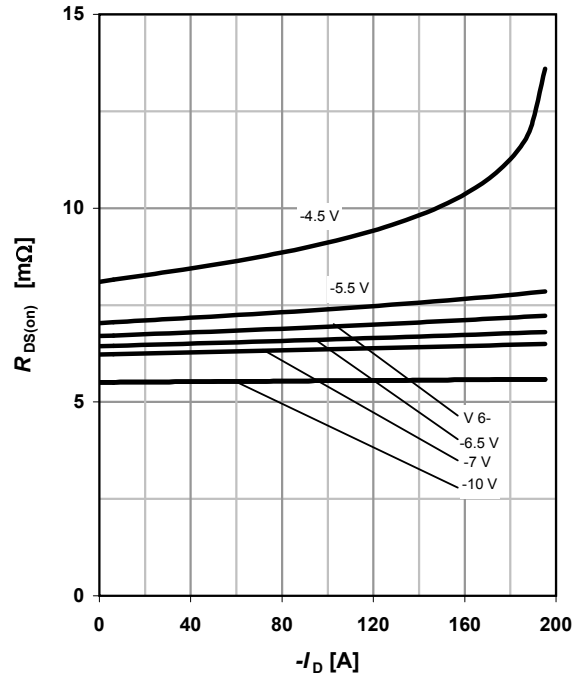

7 Typ. transfer characteristics

$I_D = f(V_{GS}); |V_{DS}| > 2|I_D|R_{DS(on)max}$

parameter: T_j

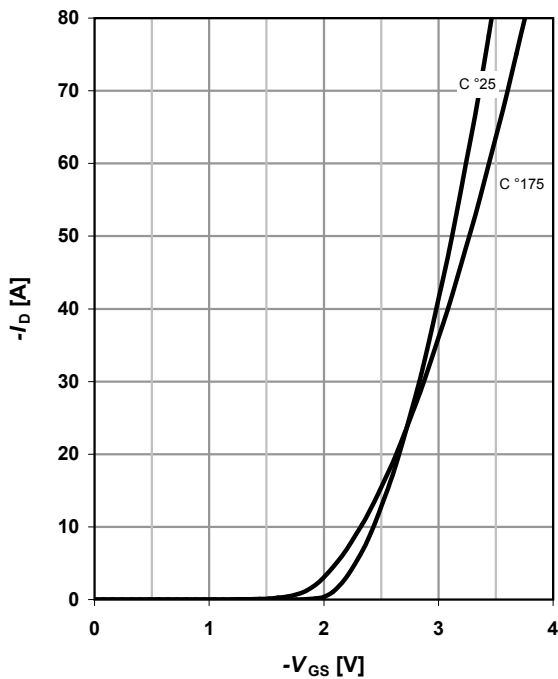

8 Typ. forward transconductance

$g_{fs} = f(I_D); T_j = 25\text{ }^\circ\text{C}$

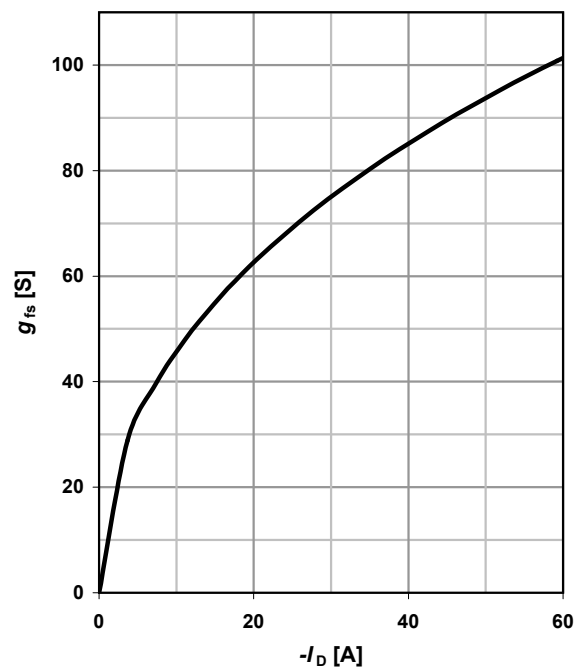

9 Drain-source on-state resistance

$R_{DS(on)} = f(T_j); I_D = -50 \text{ A}; V_{GS} = -10 \text{ V}$

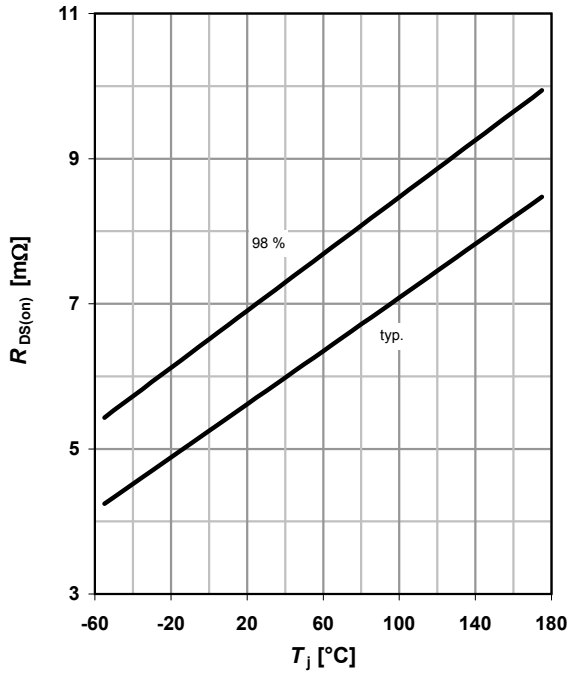

10 Typ. gate threshold voltage

$V_{GS(th)} = f(T_j); V_{GS} = V_{DS}; I_D = -250 \mu\text{A}$

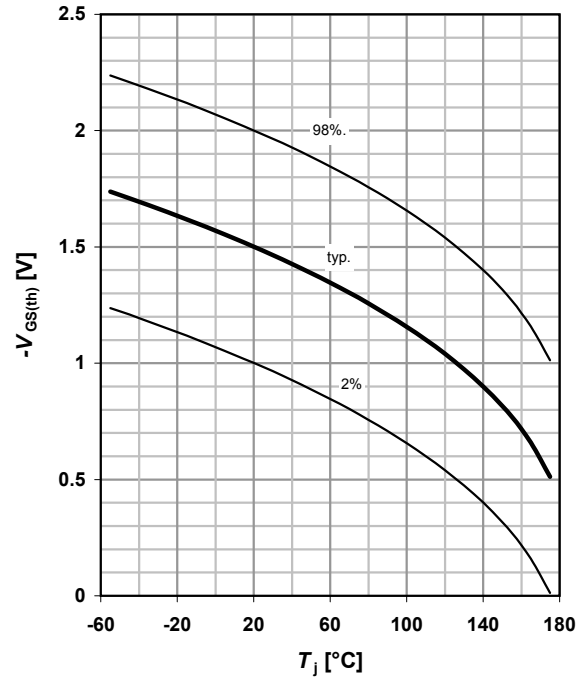

11 Typ. capacitances

$C = f(V_{DS}); V_{GS} = 0 \text{ V}; f = 1 \text{ MHz}$

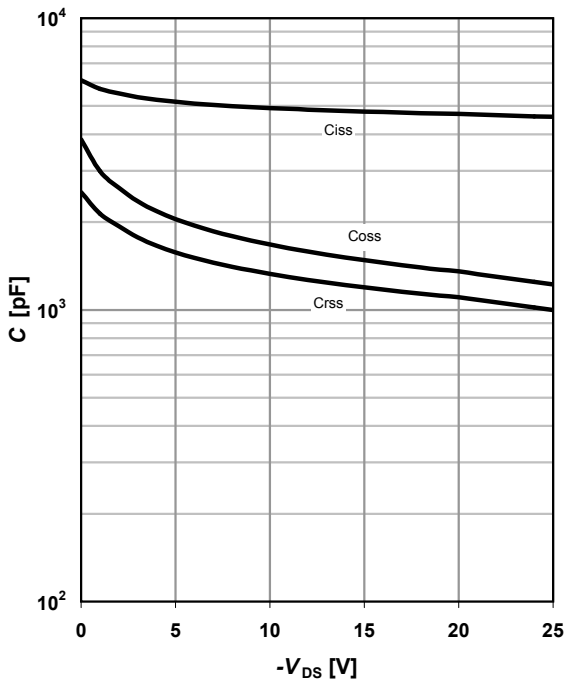

12 Forward characteristics of reverse diode

$I_F = f(V_{SD})$

parameter: T_j

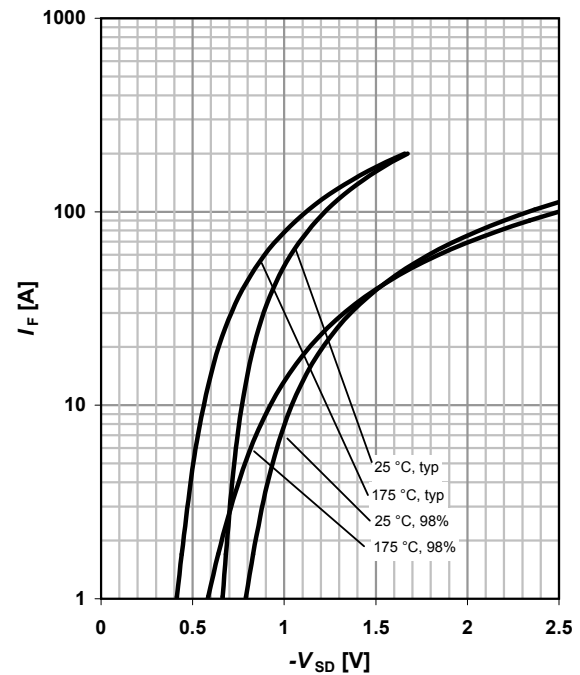

13 Avalanche characteristics

$$I_{AS} = f(t_{AV}); R_{GS} = 25 \Omega$$

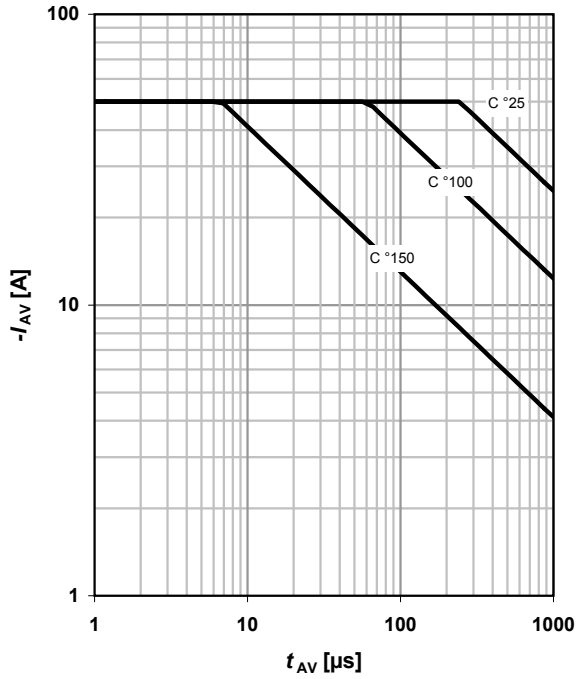
 parameter: $T_{j(\text{start})}$

14 Typ. gate charge

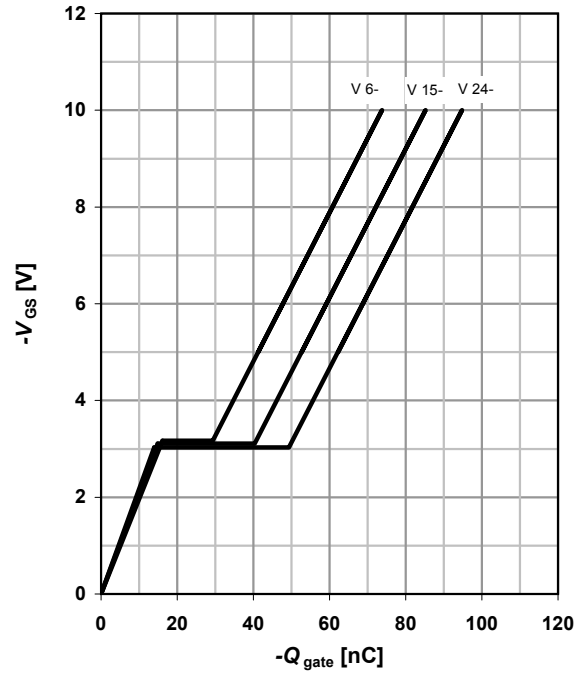
$$V_{GS} = f(Q_{\text{gate}}); I_D = -50 \text{ A pulsed}$$

 parameter: V_{DD}

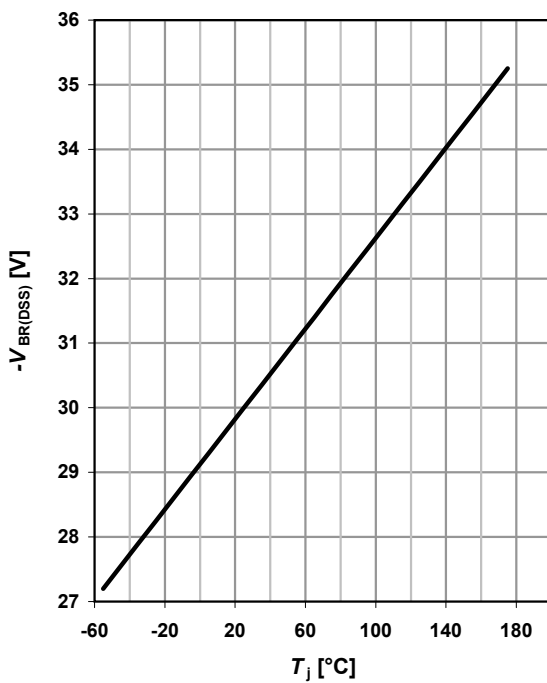
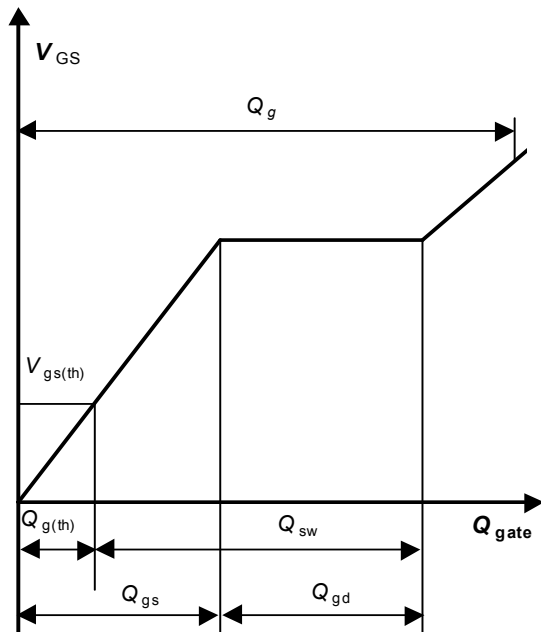
15 Drain-source breakdown voltage

$$V_{BR(DSS)} = f(T_j); I_D = -250 \mu\text{A}$$

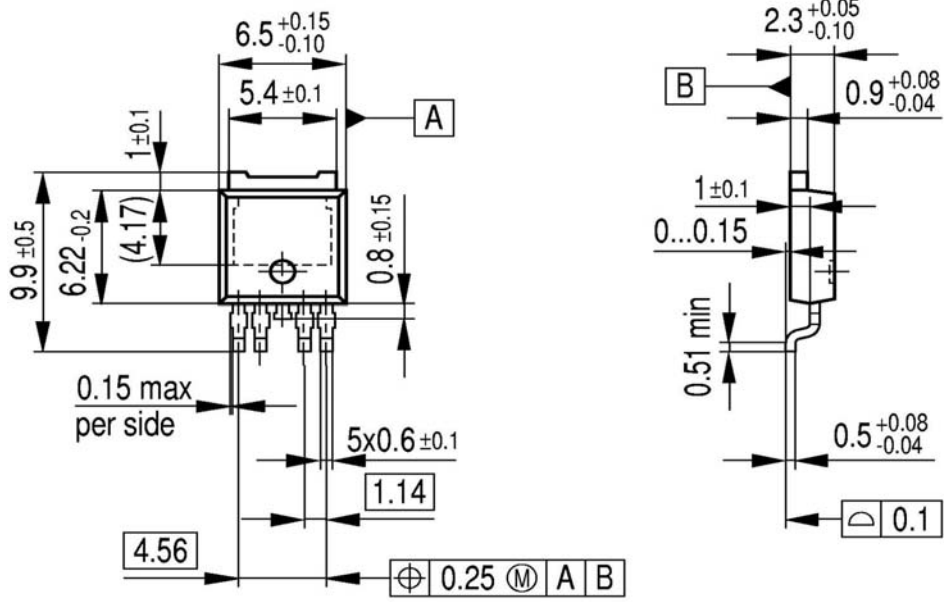

16 Gate charge waveforms

Package Outline

PG-TO252-5: Outline

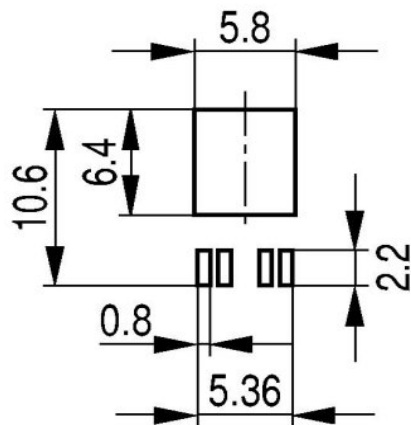

Footprint



Packaging Tape

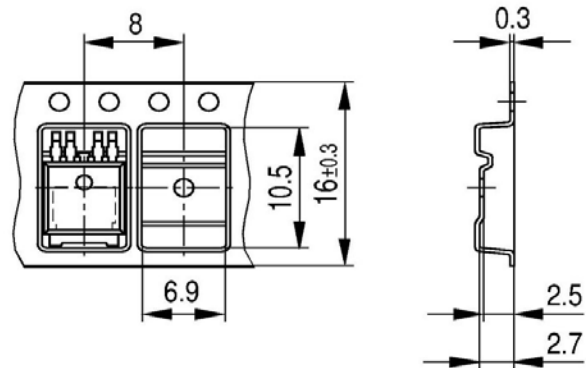

Dimensions in mm

Published by
Infineon Technologies AG
81726 Munich, Germany
© 2008 Infineon Technologies AG
All Rights Reserved.

Legal Disclaimer

The information given in this document shall in no event be regarded as a guarantee of conditions or characteristics. With respect to any examples or hints given herein, any typical values stated herein and/or any information regarding the application of the device, Infineon Technologies hereby disclaims any and all warranties and liabilities of any kind, including without limitation, warranties of non-infringement of intellectual property rights of any third party.

Information

For further information on technology, delivery terms and conditions and prices, please contact the nearest Infineon Technologies Office (www.infineon.com).

Warnings

Due to technical requirements, components may contain dangerous substances. For information on the types in question, please contact the nearest Infineon Technologies Office. Infineon Technologies components may be used in life-support devices or systems only with the express written approval of Infineon Technologies, if a failure of such components can reasonably be expected to cause the failure of that life-support device or system or to affect the safety or effectiveness of that device or system. Life support devices or systems are intended to be implanted in the human body or to support and/or maintain and sustain and/or protect human life. If they fail, it is reasonable to assume that the health of the user or other persons may be endangered.

Mouser Electronics

Authorized Distributor

Click to View Pricing, Inventory, Delivery & Lifecycle Information:

[Infineon:](#)

[SPD50P03LGBTMA1](#)