

MOSFET

Metal Oxide Semiconductor Field Effect Transistor

CoolMOS™ C3 800V

800V CoolMOS™ C3 Power Transistor
SPW55N80C3

Data Sheet

Rev. 2.0
Final

Industrial & Multimarket

1 Description

800V CoolMOS™ C3 designed for:

- Industrial application with high DC bulk voltage
- Switching Application (i.e. active clamp forward)

Features

New revolutionary high voltage technology

- Extreme dv/dt rated
- High peak current capability
- Qualified according to JEDEC1) for target applications
- Pb-free lead plating; RoHS compliant
- Ultra low gate charge
- Ultra low effective capacitances

Applications

PFC stages, hard switching PWM stages and resonant switching PWM stages for e.g. PC Silverbox, Adapter, LCD & PDP TV, Lighting, Server, Telecom, UPS and Solar.

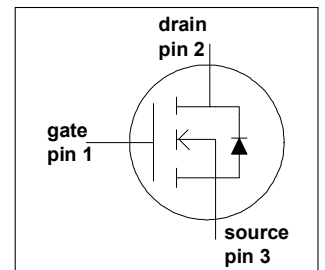
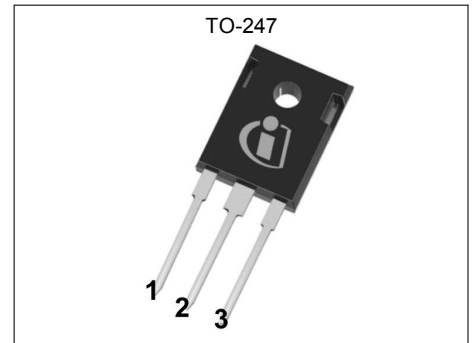

Table 1 Key Performance Parameters

Parameter	Value	Unit
$V_{DS} @ T_{j, max}$	850	V
$R_{DS(on), max}$	0.085	Ω
Q_g, typ	288	nC
$I_{D, pulse}$	150	A
$E_{oss} @ 400V$	21.5	μJ
Body diode di/dt	100	A/ μs



Type / Ordering Code	Package	Marking	Related Links
SPW55N80C3	PG-TO 247	55N80C3	see Appendix A



Table of Contents

Description 2

Table of Contents 3

Maximum ratings 4

Thermal characteristics 5

Electrical characteristics 6

Electrical characteristics diagrams 8

Test Circuits 12

Package Outlines 13

Appendix A 14

Revision History 15

Disclaimer 15

2 Maximum ratings

at $T_j = 25^\circ\text{C}$, unless otherwise specified

Table 2 Maximum ratings

Parameter	Symbol	Values			Unit	Note / Test Condition
		Min.	Typ.	Max.		
Continuous drain current ¹⁾	I_D			54.9	A	$T_C = 25^\circ\text{C}$
				34.7		$T_C = 100^\circ\text{C}$
Pulsed drain current ²⁾	$I_{D,pulse}$			150	A	$T_C = 25^\circ\text{C}$
Avalanche energy, single pulse	E_{AS}			2150	mJ	$I_b = 9.5\text{A}$, $V_{DD} = 50\text{V}$
Avalanche energy, repetitive	E_{AR}			3.26	mJ	$I_b = 9.5\text{A}$, $V_{DD} = 50\text{V}$
Avalanche current, repetitive	I_{AR}			9.5	A	
MOSFET dv/dt ruggedness	dv/dt			50	V/ns	$V_{DS} = 0 \dots 400\text{V}$
Gate source voltage	V_{GS}	-20		20	V	static
		-30		30		AC ($f > 1\text{ Hz}$)
Power dissipation (non FullPAK) TO-247	P_{tot}			500.0	W	$T_C = 25^\circ\text{C}$
Operating and storage temperature	T_j, T_{stg}	-55		150	$^\circ\text{C}$	
Mounting torque (non FullPAK) TO-247				60	Ncm	M3 and M3.5 screws
Continuous diode forward current	I_S			47.6	A	$T_C = 25^\circ\text{C}$
Diode pulse current	$I_{S,pulse}$			150	A	$T_C = 25^\circ\text{C}$
Reverse diode dv/dt ³⁾	dv/dt			4	V/ns	$V_{DS} = 0 \dots 400\text{V}$, $I_{SD} \leq I_b$, $T_j = 25^\circ\text{C}$
Maximum diode commutation speed	di_f/dt			100	A/ μs	

¹⁾ Limited by $T_{j,max}$. Maximum duty cycle $D=0.75$

²⁾ Pulse width t_p limited by $T_{j,max}$

³⁾ $V_{peak} < V_{(BR)DSS}$, $T_j < T_{j,max}$, identical low and high side switch with same R_g

3 Thermal characteristics

Table 3 Thermal characteristics TO-247

Parameter	Symbol	Values			Unit	Note / Test Condition
		Min.	Typ.	Max.		
Thermal resistance, junction - case	R_{thJC}			0.25	°C/W	
Thermal resistance, junction - ambient	R_{thJA}			62	°C/W	leaded
Soldering temperature, wavesoldering only allowed at leads	T_{sold}			260	°C	1.6 mm (0.063 in.) from case for 10s

4 Electrical characteristics

at $T_j = 25^\circ\text{C}$, unless otherwise specified

Table 4 Static characteristics

Parameter	Symbol	Values			Unit	Note / Test Condition
		Min.	Typ.	Max.		
Drain-source breakdown voltage	$V_{(BR)DSS}$	800			V	$V_{GS} = 0V, I_D = 0.25mA$
Gate threshold voltage	$V_{GS(th)}$	2.1	3	3.9	V	$V_{DS} = V_{GS}, I_D = 3.3mA$
Zero gate voltage drain current	I_{DSS}			25	μA	$V_{DS} = 800V, V_{GS} = 0V, T_j = 25^\circ C$
			150			$V_{DS} = 800V, V_{GS} = 0V, T_j = 150^\circ C$
Gate-source leakage current	I_{GSS}			100	nA	$V_{GS} = 20V, V_{DS} = 0V$
Drain-source on-state resistance	$R_{DS(on)}$		0.077	0.085	Ω	$V_{GS} = 10V, I_D = 32.6A, T_j = 25^\circ C$
			0.199			$V_{GS} = 10V, I_D = 32.6A, T_j = 150^\circ C$
Gate resistance	R_G		0.8		Ω	$f = 1MHz, \text{open drain}$

Table 5 Dynamic characteristics

Parameter	Symbol	Values			Unit	Note / Test Condition
		Min.	Typ.	Max.		
Input capacitance	C_{iss}		7520		pF	$V_{GS} = 0V, V_{DS} = 100V, f = 1MHz$
Output capacitance	C_{oss}		305		pF	
Effective output capacitance, energy related ¹⁾	$C_{o(er)}$		1535		pF	$V_{GS} = 0V, V_{DS} = 0 \dots 400V$
Effective output capacitance, time related ²⁾	$C_{o(tr)}$		277		pF	$I_D = \text{constant}, V_{GS} = 0V, V_{DS} = 0 \dots 400V$
Turn-on delay time	$t_{d(on)}$		45		ns	$V_{DD} = 400V, V_{GS} = 13V, I_D = 54.9A, R_G = 3.4\Omega$
Rise time	t_r		21		ns	
Turn-off delay time	$t_{d(off)}$		200		ns	
Fall time	t_f		9		ns	

Table 6 Gate charge characteristics

Parameter	Symbol	Values			Unit	Note / Test Condition
		Min.	Typ.	Max.		
Gate to source charge	Q_{gs}		42		nC	$V_{DD} = 480V, I_D = 54.9A, V_{GS} = 0 \text{ to } 10V$
Gate to drain charge	Q_{gd}		125		nC	
Gate charge total	Q_g		288		nC	
Gate plateau voltage	$V_{plateau}$		5.5		V	

¹⁾ $C_{o(er)}$ is a fixed capacitance that gives the same stored energy as C_{oss} while V_{DS} is rising from 0 to 400V

²⁾ $C_{o(tr)}$ is a fixed capacitance that gives the same charging time as C_{oss} while V_{DS} is rising from 0 to 400V

Table 7 Reverse diode characteristics

Parameter	Symbol	Values			Unit	Note / Test Condition
		Min.	Typ.	Max.		
Diode forward voltage	V_{SD}		0.95		V	$V_{GS} = 0V, I_F = 54.9A, T_j = 25^\circ C$
Reverse recovery time	t_{rr}		1050		ns	$V_R = 400V, I_F = 54.9A, dI/dt = 100A/\mu s$
Reverse recovery charge	Q_{rr}		43		μC	
Peak reverse recovery current	I_{rrm}		78		A	

5 Electrical characteristics diagrams

Table 8

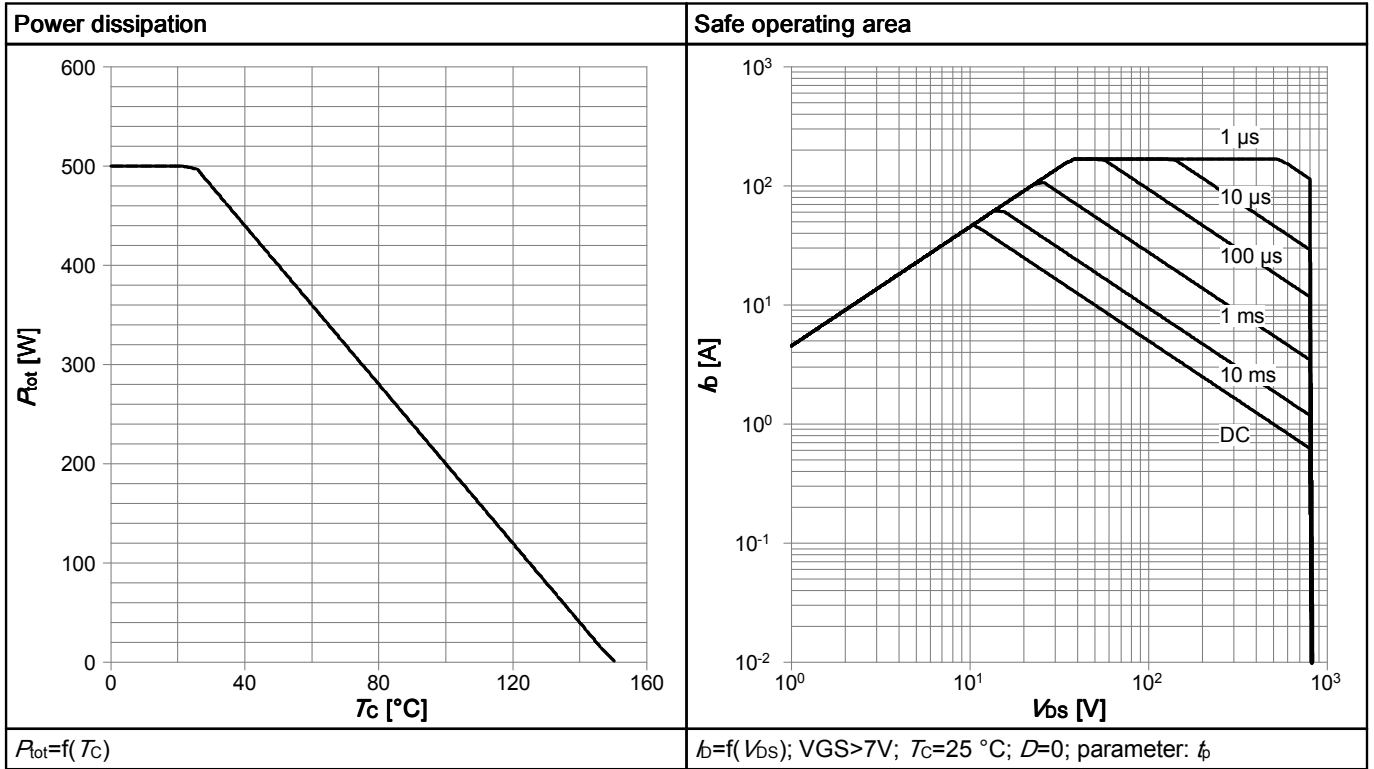

Table 9

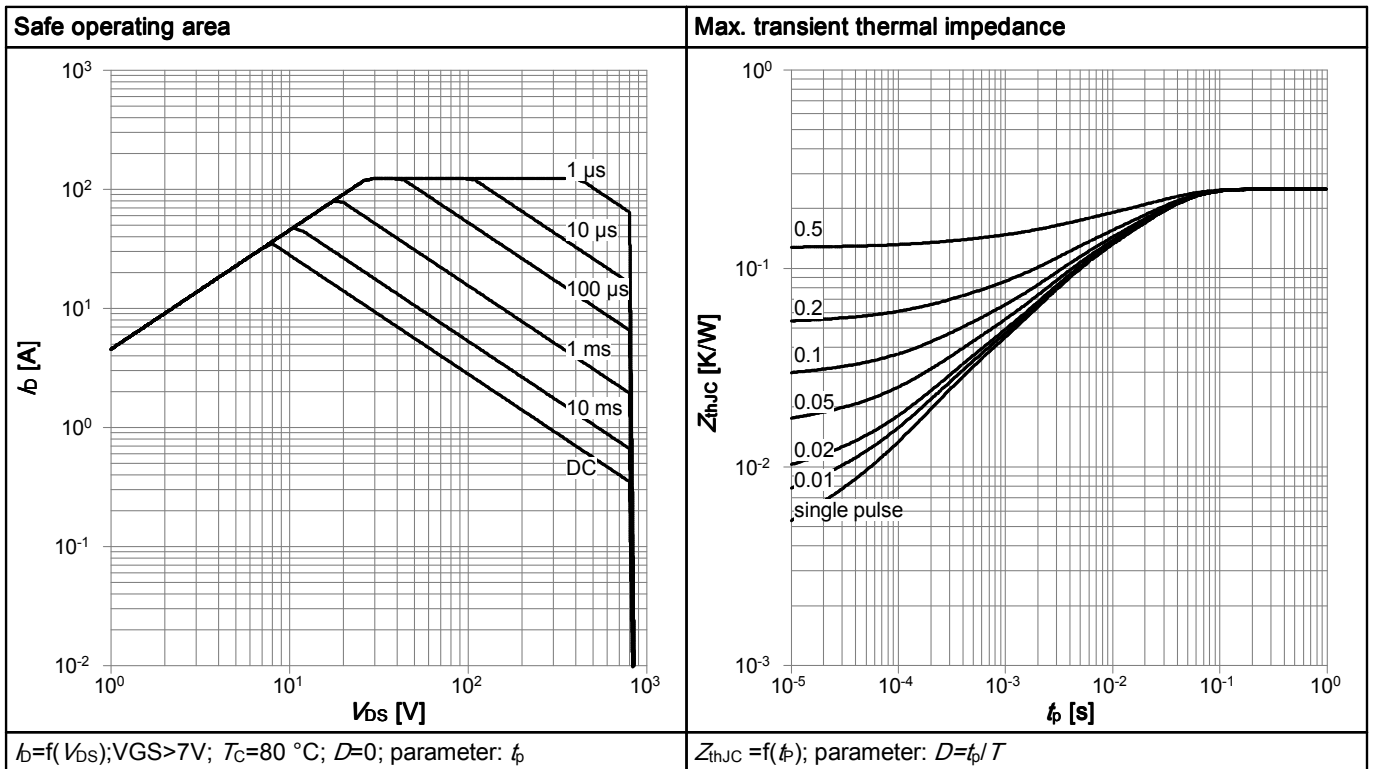

Table 10

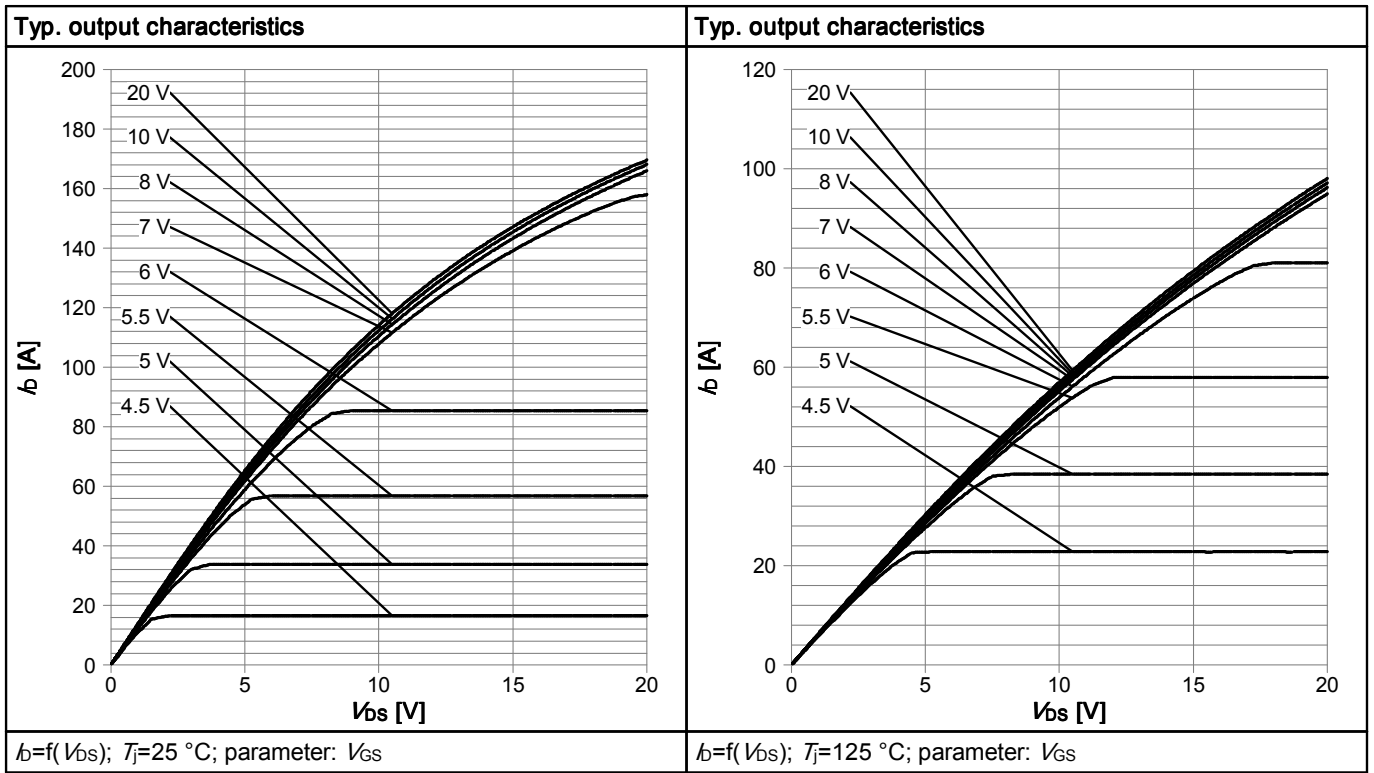

Table 11

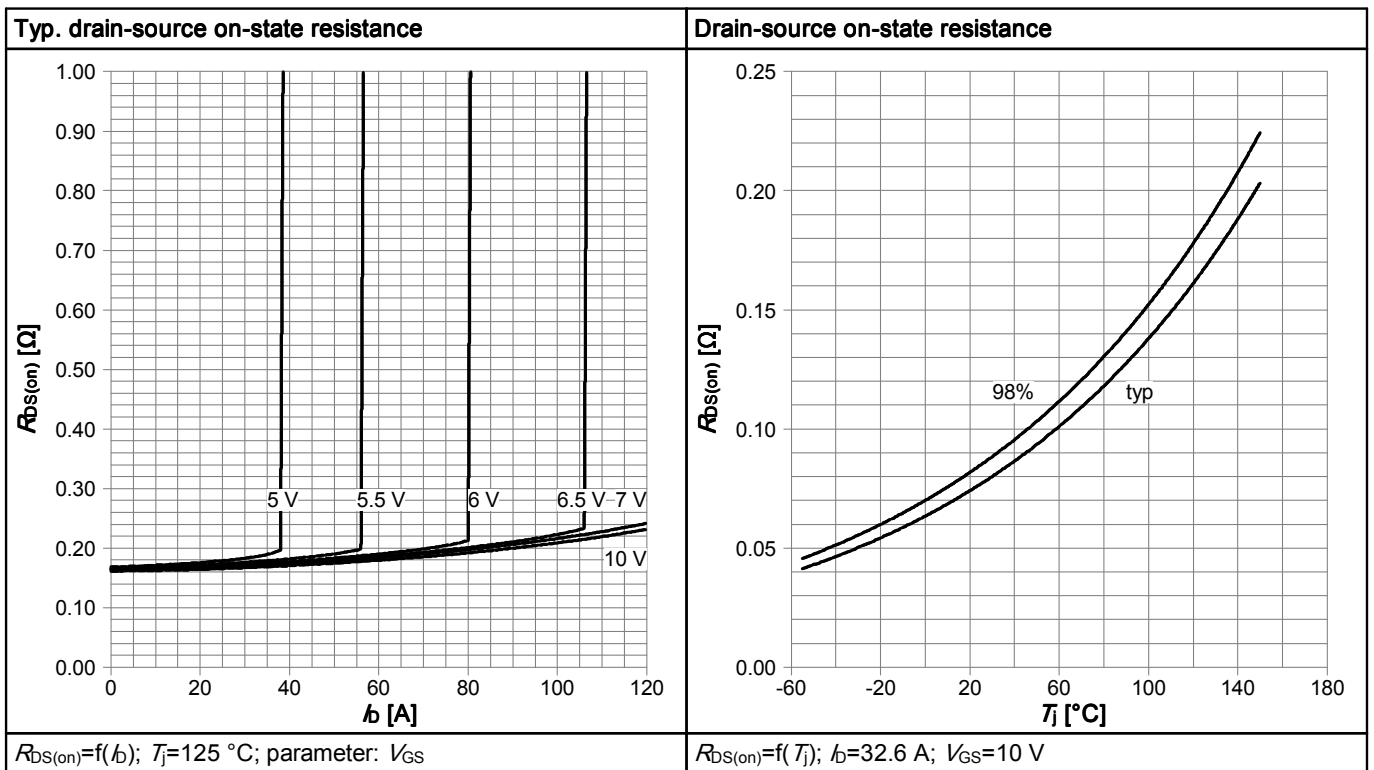

Table 12

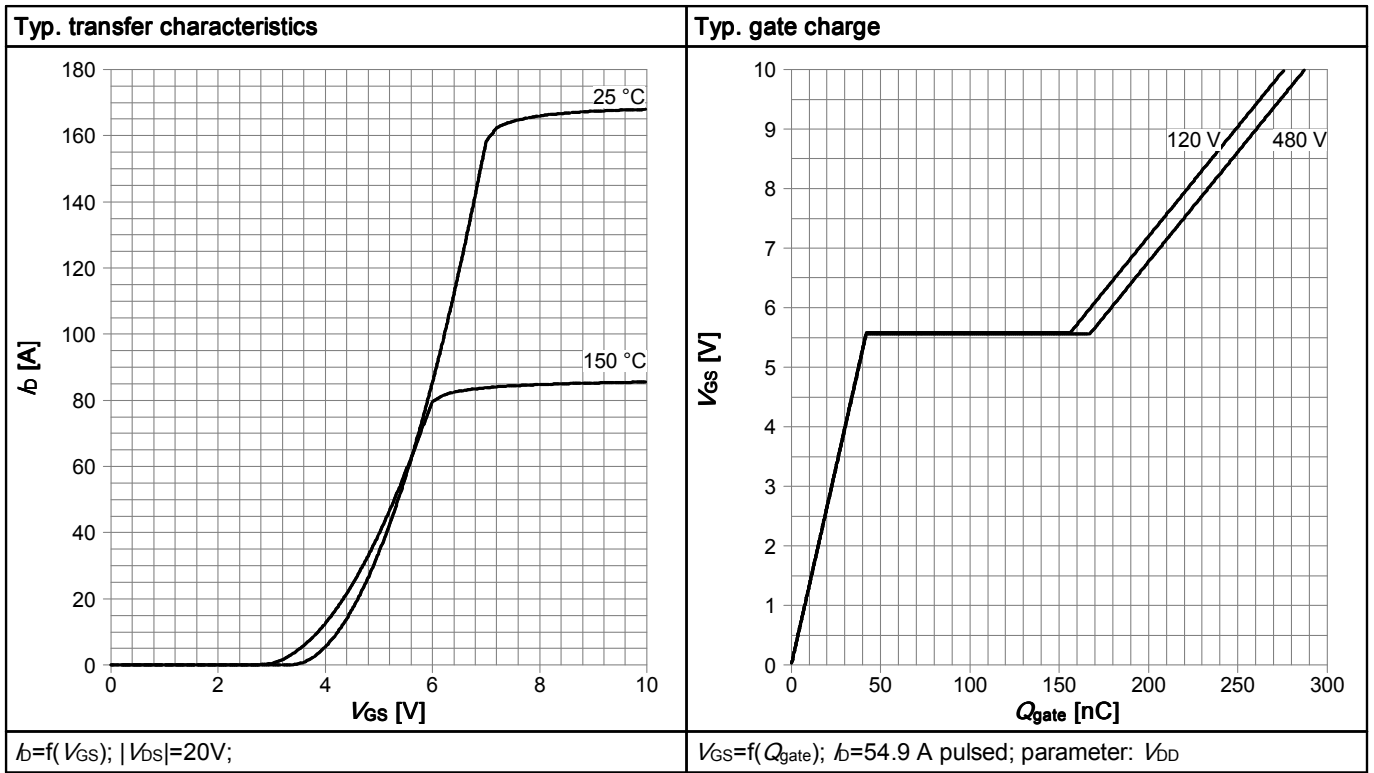

Table 13

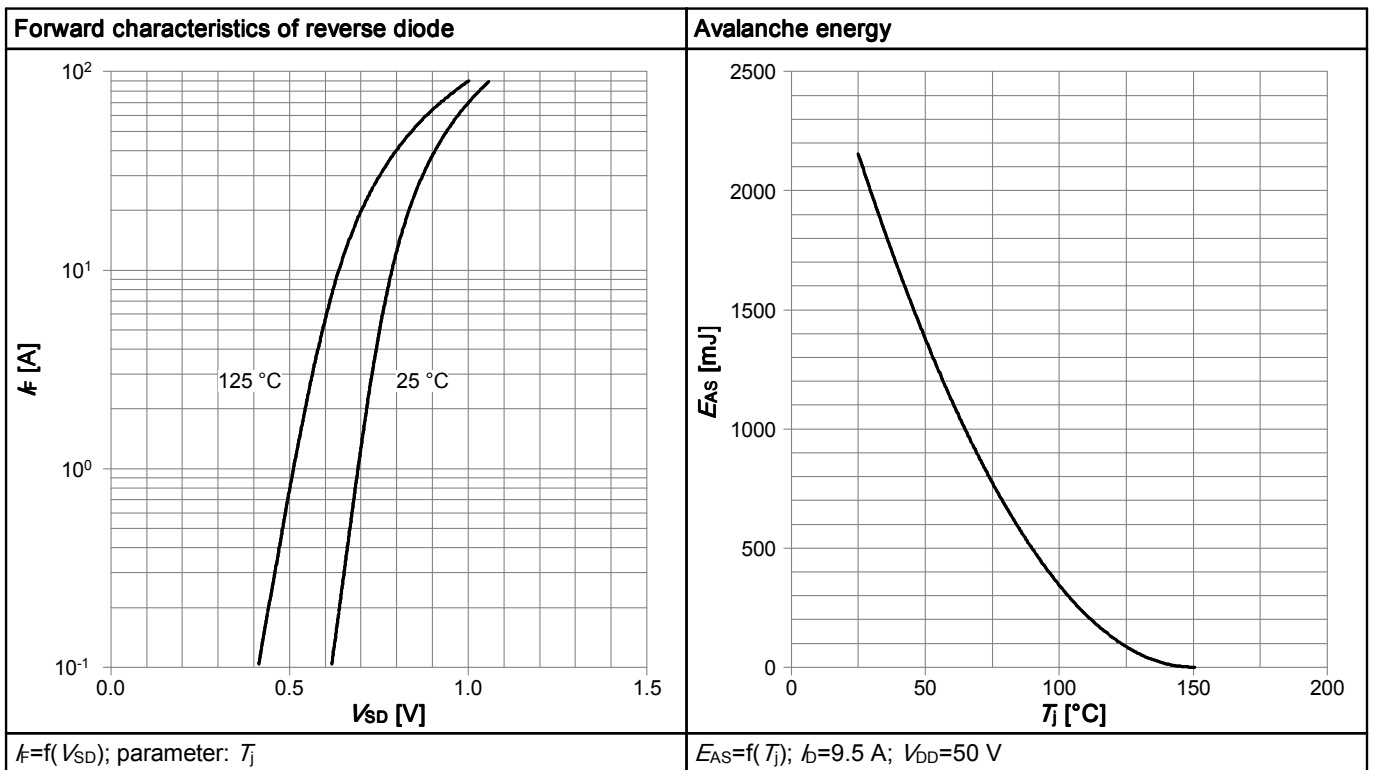

Table 14

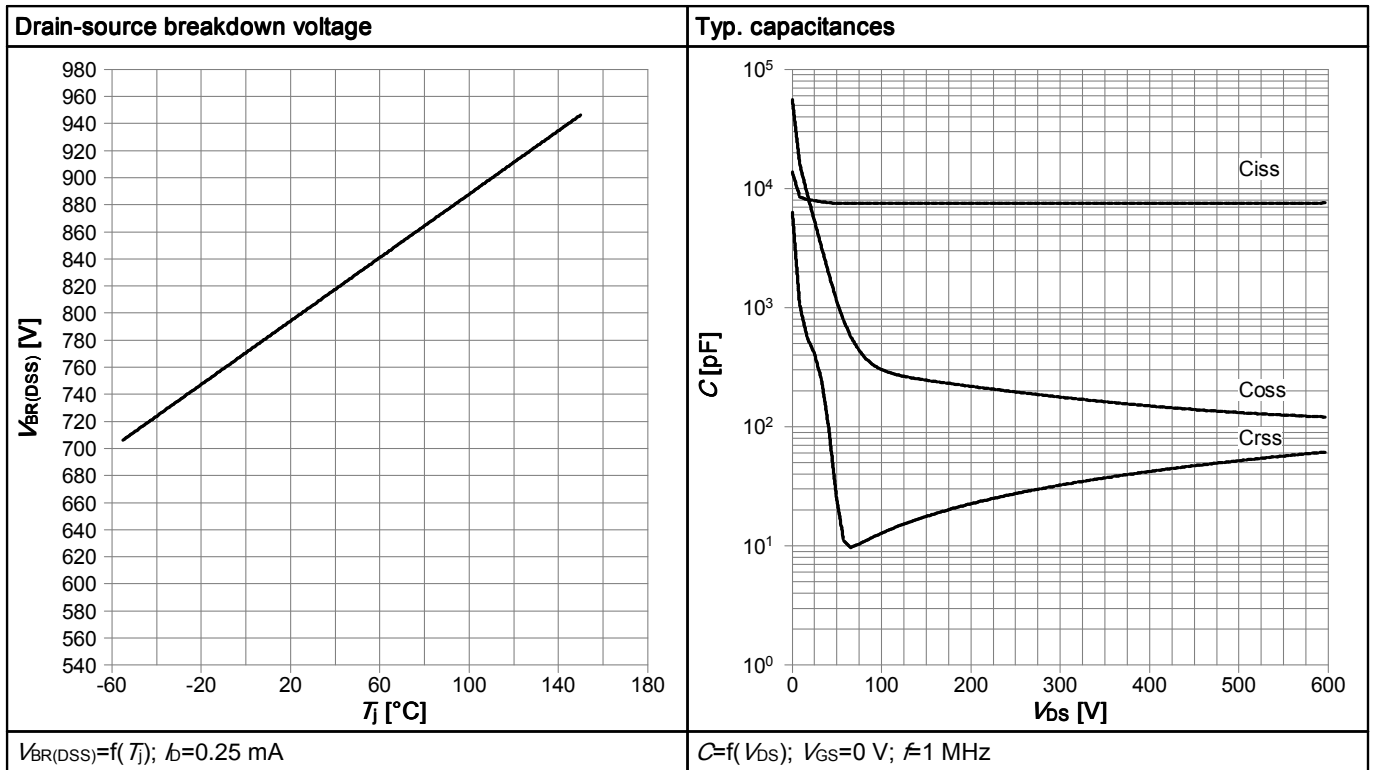
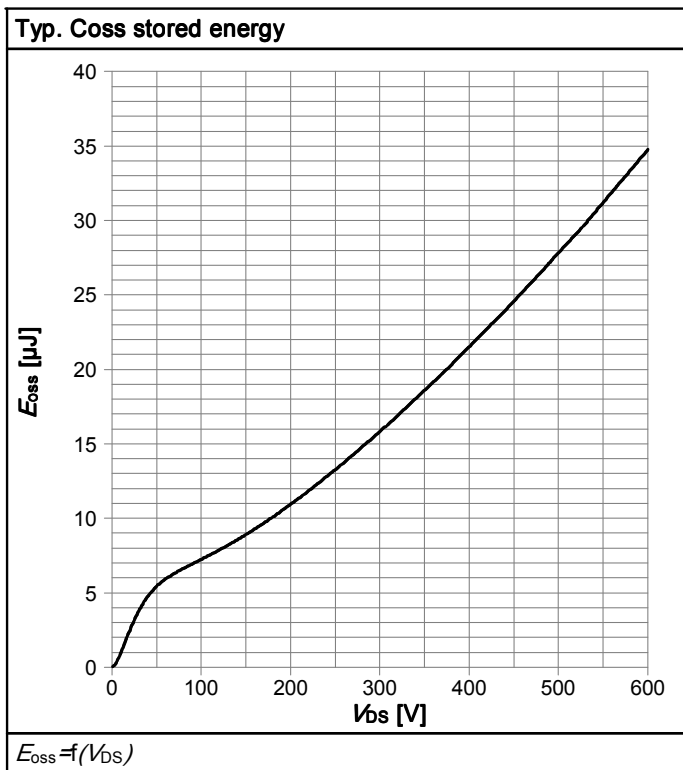

Table 15



6 Test Circuits

Table 16 Diode_characteristics

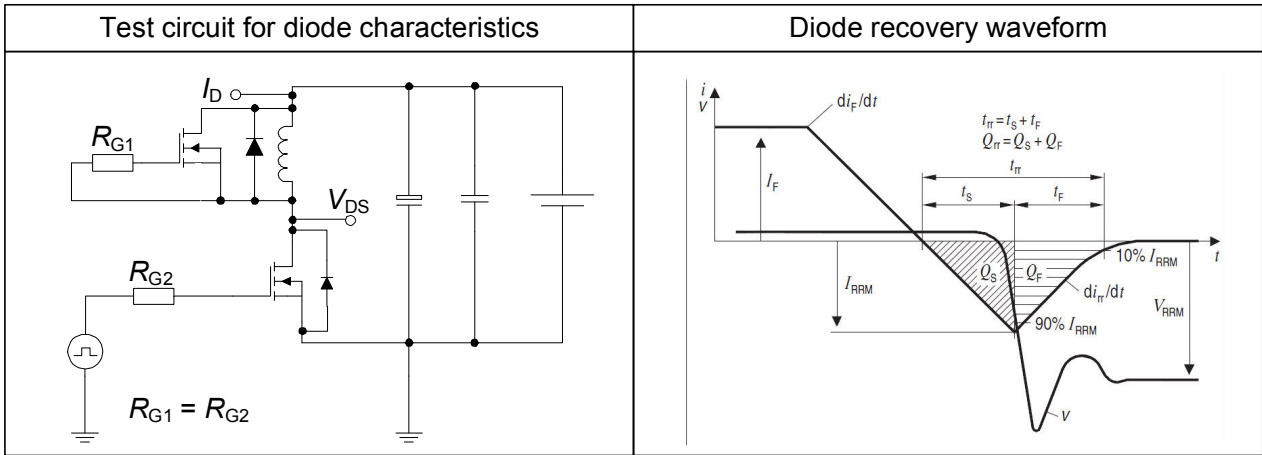

Table 17 Switching_times

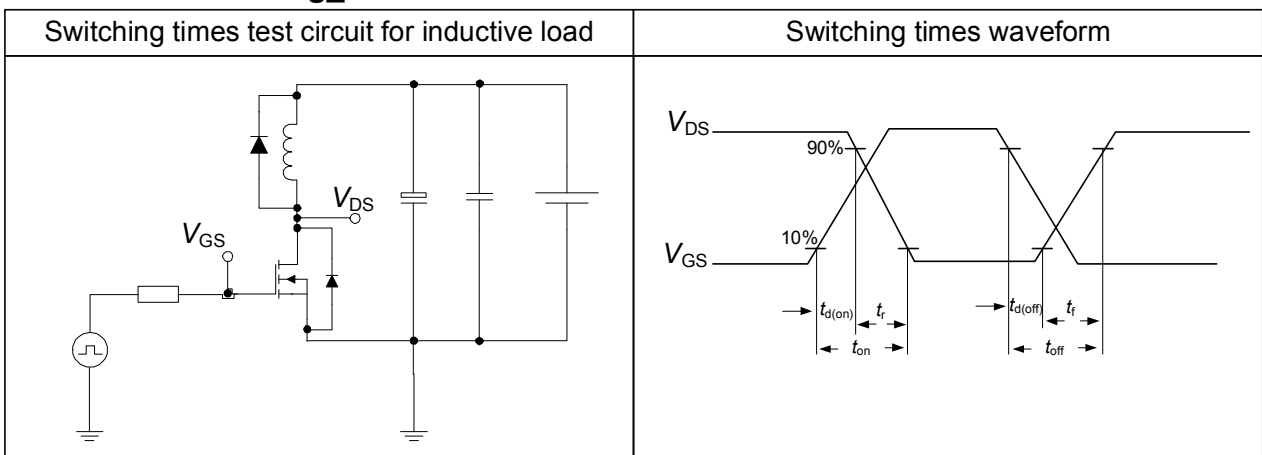
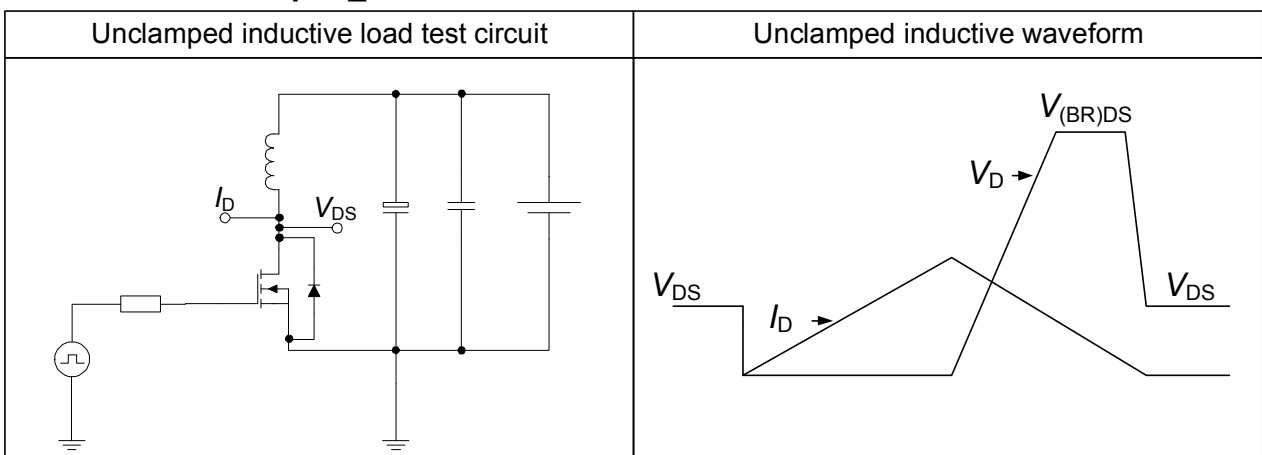

Table 18 Unclamped_inductive



7 Package Outlines

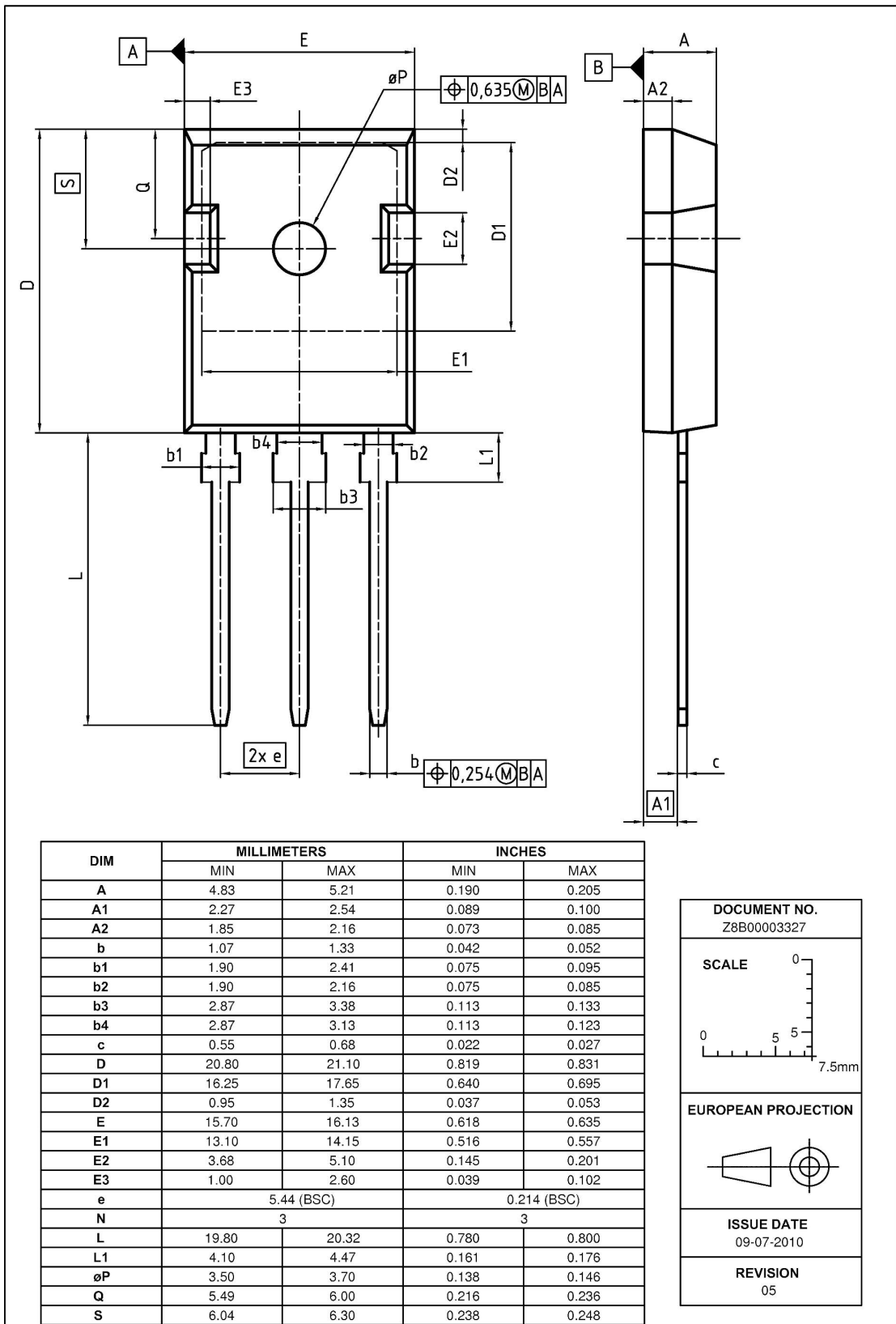

Figure 1 Outline PG-TO 247, dimensions in mm/inches

8 Appendix A

Table 19 Related Links

- **IFX CoolMOS Webpage:**
<http://www.infineon.com/cms/en/product/channel.html?channel=ff80808112ab681d0112ab6a628704d8>
- **IFX Design Tools:**
<http://www.infineon.com/cms/en/product/promopages/designtools/index.html>

Revision History

SPW55N80C3

Revision: 2011-10-12, Rev. 2.2

Previous Revision

Revision	Date	Subjects (major changes since last revision)
2.0	2011-09-26	release of final datasheet

We Listen to Your Comments

Any information within this document that you feel is wrong, unclear or missing at all? Your feedback will help us to continuously improve the quality of this document. Please send your proposal (including a reference to this document) to: erratum@infineon.com

Edition 2011-08-01

Published by

Infineon Technologies AG

81726 München, Germany

© 2011 Infineon Technologies AG

All Rights Reserved.

Legal Disclaimer

The information given in this document shall in no event be regarded as a guarantee of conditions or characteristics. With respect to any examples or hints given herein, any typical values stated herein and/or any information regarding the application of the device, Infineon Technologies hereby disclaims any and all warranties and liabilities of any kind, including without limitation, warranties of non-infringement of intellectual property rights of any third party.

Information

For further information on technology, delivery terms and conditions and prices please contact your nearest Infineon Technologies Office (www.infineon.com).

Warnings

Due to technical requirements, components may contain dangerous substances. For information on the types in question, please contact the nearest Infineon Technologies Office.

The Infineon Technologies component described in this Data Sheet may be used in life-support devices or systems and/or automotive, aviation and aerospace applications or systems only with the express written approval of Infineon Technologies, if a failure of such components can reasonably be expected to cause the failure of that life-support, automotive, aviation and aerospace device or system or to affect the safety or effectiveness of that device or system. Life support devices or systems are intended to be implanted in the human body or to support and/or maintain and sustain and/or protect human life. If they fail, it is reasonable to assume that the health of the user or other persons may be endangered.

Mouser Electronics

Authorized Distributor

Click to View Pricing, Inventory, Delivery & Lifecycle Information:

[Infineon:](#)

[SPW55N80C3](#)