

## 2-Phase Stepper-Motor Driver Bipolar-IC

TLE4729G



### Features

- 2 × 0.7 amp. full bridge outputs
- Integrated driver, control logic and current control (chopper)
- Very low current consumption in inhibit mode
- Fast free-wheeling diodes
- Max. supply voltage 45 V
- Output stages are free of crossover current
- Offset-phase turn-ON of output stages
- All outputs short-circuit proof
- Error-flag for overload, open load, over-temperature
- SMD package PG-DSO-24-16
- Green Product (RoHS compliant)
- AEC Qualified



Type	Package
TLE4729G	PG-DSO-24-16 (SMD)

### Functional Description

TLE4729G is a bipolar, monolithic IC for driving bipolar stepper motors, DC motors and other inductive loads that operate by constant current. It is fully pin and function compatible except the current programming is inverse to the TLE4728G with an additional inhibit feature. The control logic and power output stages for two bipolar windings are integrated on a single chip which permits switched current control of motors with 0.7 A per phase at operating voltages up to 16 V.

The direction and value of current are programmable for each phase via separate control inputs. In the case of low at all four current program inputs the device is switched to inhibit mode automatically. A common oscillator generates the timing for the current control and turn-on with phase offset of the two output stages. The two output stages in full-bridge configuration include fast integrated freewheeling diodes and are free of crossover current. The device can be driven directly by a microprocessor in several modes by programming phase direction and current control of each bridge independently.

With the two error outputs the TLE4729G signals malfunction of the device. Setting the control inputs low resets the error flag and by reactivating the bridges one by one the location of the error can be found.

**Pin Configuration**  
(top view)

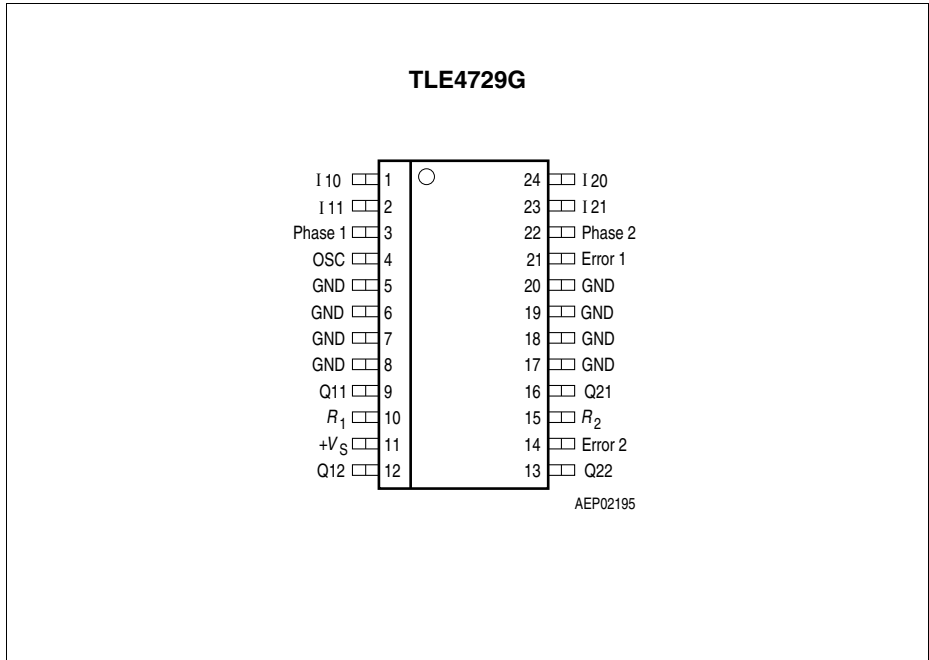

**Figure 1**

**Pin Definitions and Functions**

Pin	Function																				
1, 2, 23, 24	<p><b>Digital control inputs IX0, IX1</b> for the magnitude of the current of the particular phase.</p> <p><math>I_{\text{set}} = 450 \text{ mA}</math> with <math>R_{\text{sense}} = 1 \Omega</math></p> <table border="1"> <thead> <tr> <th>IX1</th> <th>IX0</th> <th>Phase Current</th> <th>Example of Motor Status</th> </tr> </thead> <tbody> <tr> <td>L</td> <td>L</td> <td>0</td> <td>No current<sup>1)</sup></td> </tr> <tr> <td>L</td> <td>H</td> <td><math>0.155 \times I_{\text{set}}</math></td> <td>Hold</td> </tr> <tr> <td>H</td> <td>L</td> <td><math>I_{\text{set}}</math></td> <td>Normal mode</td> </tr> <tr> <td>H</td> <td>H</td> <td><math>1.55 \times I_{\text{set}}</math></td> <td>Accelerate</td> </tr> </tbody> </table> <p><sup>1)</sup> "No current" in both bridges inhibits the circuit and current consumption will sink below 50 <math>\mu\text{A}</math> (inhibit-mode)</p>	IX1	IX0	Phase Current	Example of Motor Status	L	L	0	No current <sup>1)</sup>	L	H	$0.155 \times I_{\text{set}}$	Hold	H	L	$I_{\text{set}}$	Normal mode	H	H	$1.55 \times I_{\text{set}}$	Accelerate
IX1	IX0	Phase Current	Example of Motor Status																		
L	L	0	No current <sup>1)</sup>																		
L	H	$0.155 \times I_{\text{set}}$	Hold																		
H	L	$I_{\text{set}}$	Normal mode																		
H	H	$1.55 \times I_{\text{set}}$	Accelerate																		
3	<p><b>Input phase 1</b>; controls the current through phase winding 1. On H-potential the phase current flows from Q11 to Q12, on L-potential in the reverse direction.</p>																				
5 ... 8, 17 ... 20	<p><b>Ground</b>; all pins are connected at leadframe internally.</p>																				
4	<p><b>Oscillator</b>; works at approx. 25 kHz if this pin is wired to ground across 2.2 nF.</p>																				
10	<p><b>Resistor <math>R_1</math></b> for sensing the current in phase 1.</p>																				
9, 12	<p><b>Push-pull outputs Q11, Q12</b> for phase 1 with integrated free-wheeling diodes.</p>																				
11	<p><b>Supply voltage</b>; block to ground, as close as possible to the IC, with a stable electrolytic capacitor of at least 47 <math>\mu\text{F}</math> in parallel with a ceramic capacitor of 100 nF.</p>																				
14	<p><b>Error 2 output</b>; signals with "low" the errors: short circuit to ground of one or more outputs or over-temperature.</p>																				
13, 16	<p><b>Push-pull outputs Q22, Q21</b> for phase 2 with integrated free-wheeling diodes.</p>																				
15	<p><b>Resistor <math>R_2</math></b> for sensing the current in phase 2.</p>																				
21	<p><b>Error 1 output</b>; signals with "low" the errors: open load or short circuit to + <math>V_S</math> of one or more outputs or short circuit of the load or over-temperature.</p>																				
22	<p><b>Input phase 2</b>; controls the current flow through phase winding 2. On H-potential the phase current flows from Q21 to Q22, on L-potential in the reverse direction.</p>																				

Block Diagram

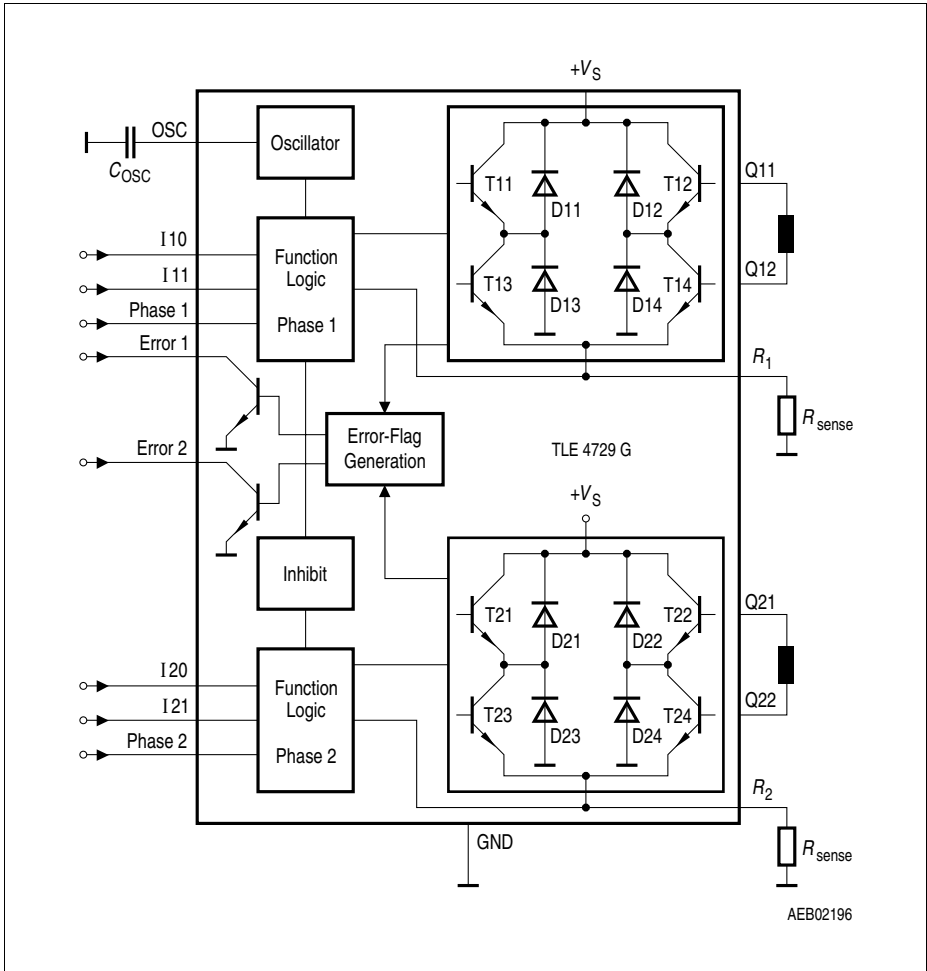

Figure 2

**Absolute Maximum Ratings**
 $T_j = -40$  to  $150$  °C

Parameter	Symbol	Limit Values		Unit	Remarks
		min.	max.		
Supply voltage	$V_S$	- 0.3	45	V	-
Error outputs	$V_{Err}$	- 0.3	45	V	-
	$I_{Err}$	-	3	mA	-
Output current	$I_Q$	- 1	1	A	-
Ground current	$I_{GND}$	- 2	-	A	-
Logic inputs	$V_{IXX}$	- 15	15	V	IXX; Phase 1, 2
Oscillator voltage	$V_{OSC}$	- 0.3	6	V	-
$R_1, R_2$ input voltage	$V_{RX}$	- 0.3	5	V	-
Junction temperature	$T_j$	- 40	150	°C	
Storage temperature	$T_{stg}$	- 50	150	°C	-
Thermal resistances					
Junction-ambient	$R_{th\ ja}$	-	75	K/W	-
Junction-ambient (soldered on a 35 $\mu$ m thick 20 cm <sup>2</sup> PC board copper area)	$R_{th\ ja}$	-	50	K/W	-
Junction-case	$R_{th\ jc}$	-	15	K/W	Measured on pin 5

**Operating Range**

Supply voltage	$V_S$	5	16	V	-
Case temperature	$T_C$	- 40	110	°C	Measured on pin 5 $P_{diss} = 2$ W
Output current	$I_Q$	- 800	800	mA	-
Logic inputs	$V_{IXX}$	- 5	+ 6	V	IXX; Phase 1, 2
Error outputs	$V_{Err}$	-	25	V	-
	$I_{Err}$	0	1	mA	-

**Characteristics**
 $V_S = 6 \text{ to } 16 \text{ V}; T_j = -40 \text{ to } 130 \text{ }^\circ\text{C}$ 

Parameter	Symbol	Limit Values			Unit	Test Condition
		min.	typ.	max.		

**Current Consumption**

From + $V_S$	$I_S$	–	–	50	$\mu\text{A}$	$I_{XX} = L; V_S = 12 \text{ V};$ $T_j \leq 85 \text{ }^\circ\text{C}$
From + $V_S$	$I_S$	20	30	50	$\text{mA}$	$I_{Q1,2} = 0 \text{ A}$

**Oscillator**

Output charging current	$I_{OSC}$	90	120	150	$\mu\text{A}$	–
Charging threshold	$V_{OSCL}$	0.8	1.3	1.9	$\text{V}$	–
Discharging threshold	$V_{OSCH}$	1.7	2.3	2.9	$\text{V}$	–
Frequency	$f_{OSC}$	18	24	30	$\text{kHz}$	$C_{OSC} = 2.2 \text{ nF}$

**Phase Current ( $V_S = 9 \dots 16 \text{ V}$ )**

Mode “no current”	$I_Q$	–	0	–	$\text{mA}$	$I_{X0} = L; I_{X1} = L$
Voltage threshold of current Comparator at $R_{sense}$ in mode:						
Hold	$V_{ch}$	40	70	100	$\text{mV}$	$I_{X0} = H; I_{X1} = L$
Setpoint	$V_{cs}$	410	450	510	$\text{mV}$	$I_{X0} = L; I_{X1} = H$
Accelerate	$V_{ca}$	630	700	800	$\text{mV}$	$I_{X0} = H; I_{X1} = H$

**Logic Inputs (Phase X)**

Threshold	$V_I$	1.2	1.7	2.2	$\text{V}$	–
Hysteresis	$V_{IHy}$	–	200	–	$\text{mV}$	–
L-input current	$I_{IL}$	–10	–1	1	$\mu\text{A}$	$V_I = 1.2 \text{ V}$
L-input current	$I_{IL}$	–100	–20	–5	$\mu\text{A}$	$V_I = 0 \text{ V}$
H-input current	$I_{IH}$	–1	0	10	$\mu\text{A}$	$V_I = 5 \text{ V}$

**Logic Inputs ( $I_{X1}; I_{X0}$ )**

Threshold	$V_I$	0.8	1.7	2.2	$\text{V}$	–
Hysteresis	$V_{IHy}$	–	200	–	$\text{mV}$	–
L-input current	$I_{IL}$	–100	–	+5	$\mu\text{A}$	$V_I = 0 \text{ V}$
H-input current	$I_{IH}$	5	20	50	$\mu\text{A}$	$V_I = 5 \text{ V}$

**Characteristics (cont'd)**
 $V_S = 6 \text{ to } 16 \text{ V}; T_j = -40 \text{ to } 130 \text{ }^\circ\text{C}$ 

Parameter	Symbol	Limit Values			Unit	Test Condition
		min.	typ.	max.		

**Error Outputs**

Saturation voltage	$V_{ErrSat}$	50	200	500	mV	$I_{Err} = 1 \text{ mA}$
Leakage current	$I_{ErrL}$	–	–	10	$\mu\text{A}$	$V_{Err} = 25 \text{ V}$

**Thermal Protection**

Shutdown	$T_{jsd}$	140	150	160	$^\circ\text{C}$	$I_{Q1,2} = 0 \text{ A}$
Prealarm	$T_{jpa}$	120	130	140	$^\circ\text{C}$	$V_{Err} = L$
Delta	$\Delta T_j$	10	20	30	K	$\Delta T_j = T_{jsd} - T_{jpa}$
Hysteresis shutdown	$T_{jsdhy}$	–	20	–	K	–
Hysteresis prealarm	$T_{jpahy}$	–	20	–	K	–

**Power Outputs**
**Diode Transistor Sink Pair**
**(D13, T13; D14, T14; D23, T23; D24, T24)**

Saturation voltage	$V_{satl}$	0.1	0.3	0.5	V	$I_Q = -0.45 \text{ A}$
Saturation voltage	$V_{satl}$	0.2	0.5	0.8	V	$I_Q = -0.7 \text{ A}$
Reverse current	$I_{RI}$	500	1000	1500	$\mu\text{A}$	$V_S = V_Q = 40 \text{ V}$
Forward voltage	$V_{FI}$	0.6	0.9	1.2	V	$I_Q = 0.45 \text{ A}$
Forward voltage	$V_{FI}$	0.7	1.0	1.3	V	$I_Q = 0.7 \text{ A}$

**Diode Transistor Source Pair**
**(T11, D11; T12, D12; T21, D21; T22, D22)**

Saturation voltage	$V_{satuC}$	0.6	1.0	1.2	V	$I_Q = 0.45 \text{ A}$ ; charge
Saturation voltage	$V_{satuD}$	0.1	0.3	0.6	V	$I_Q = 0.45 \text{ A}$ ; discharge
Saturation voltage	$V_{satuC}$	0.7	1.2	1.5	V	$I_Q = 0.7 \text{ A}$ ; charge
Saturation voltage	$V_{satuD}$	0.2	0.5	0.8	V	$I_Q = 0.7 \text{ A}$ ; discharge
Reverse current	$I_{Ru}$	400	800	1200	$\mu\text{A}$	$V_S = 40 \text{ V}, V_Q = 0 \text{ V}$
Forward voltage	$V_{Fu}$	0.7	1.0	1.3	V	$I_Q = -0.45 \text{ A}$
Forward voltage	$V_{Fu}$	0.8	1.1	1.4	V	$I_Q = -0.7 \text{ A}$
Diode leakage current	$I_{SL}$	0	3	10	mA	$I_F = -0.7 \text{ A}$

**Characteristics (cont'd)**
 $V_S = 6 \text{ to } 16 \text{ V}; T_j = -40 \text{ to } 130 \text{ }^\circ\text{C}$ 

Parameter	Symbol	Limit Values			Unit	Test Condition
		min.	typ.	max.		

**Error Output Timing**

Time Phase X to IXX	$t_{PI}$	–	5	20	$\mu\text{s}$	–
Time IXX to Phase X	$t_{IP}$	–	12	100	$\mu\text{s}$	
Delay Phase X to Error 2	$t_{PEsc}$	–	45	100	$\mu\text{s}$	
Delay Phase X to Error 1	$t_{PEol}$	–	15	50	$\mu\text{s}$	
Delay IXX to Error 2	$t_{IEsc}$	–	30	80	$\mu\text{s}$	
Reset delay after Phase X	$t_{RP}$	–	3	10	$\mu\text{s}$	
Reset delay after IXX	$t_{RI}$	–	1	5	$\mu\text{s}$	

For details see next four pages.

These parameters are not 100% tested in production, but guaranteed by design.



**Diagrams**

Timing between IXX and Phase X to prevent setting the error flag

Operating conditions:

+  $V_S = 14\text{ V}$ ,  $T_j = 25\text{ }^\circ\text{C}$ ,  $I_{err} = 1\text{ mA}$ , load = 3.3 mH, 1  $\Omega$

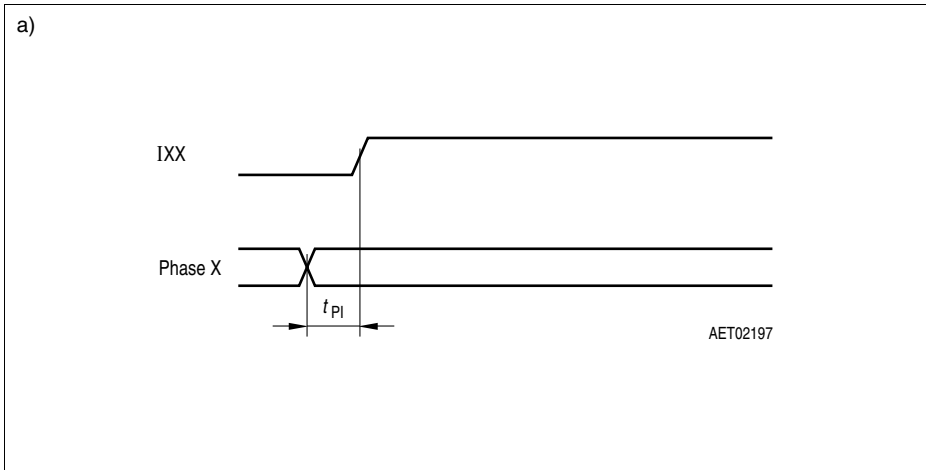

If  $t_{PI} < \text{typ. } 5\text{ }\mu\text{s}$ , an error “open load” will be set.

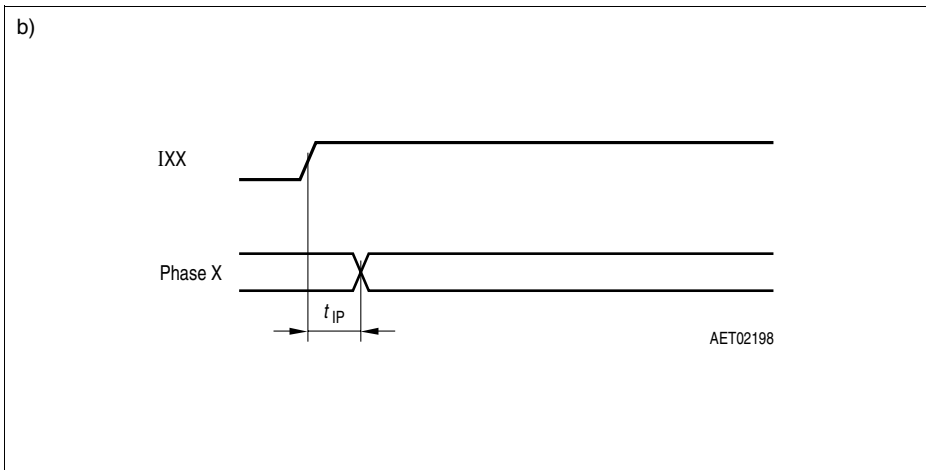

If  $t_{IP} < \text{typ. } 12\text{ }\mu\text{s}$ , an error “open load” will be set.

This time strongly depends on +  $V_S$  and inductivity of the load, see diagram below.

**Time  $t_{IP}$  vs. Load Inductivity**

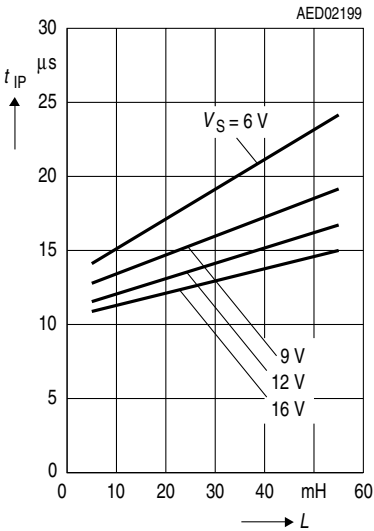

**Propagation Delay of the Error Flag**

Operating conditions:

+  $V_S = 14 V$ ,  $T_j = 25\text{ }^\circ\text{C}$ ,  $I_{err} = 1\text{ mA}$ , load = 3.3 mH, 1  $\Omega$

a) IXX = H, error condition: short circuit to GND.

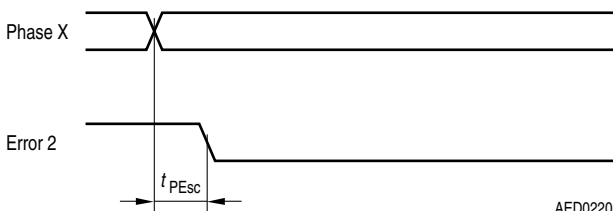

typ.  $t_{PEsc}$ : 45  $\mu\text{s}$

b)  $I_{XX} = H$ , error condition: open load (equivalent: short circuit to  $+V_S$ ).

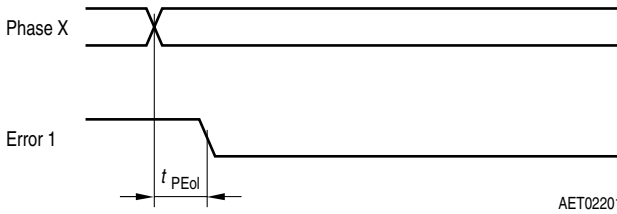

AET02201

typ.  $t_{PEol}$ : 15  $\mu$ s

c) Phase X = H or L, const.; error condition: short circuit to GND.

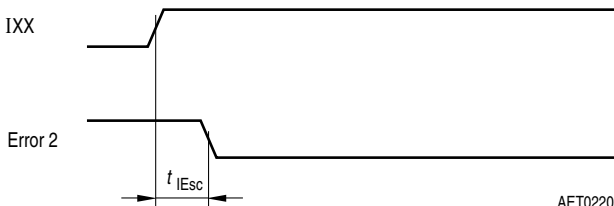

AET02202

typ.  $t_{IEsc}$ : 30  $\mu$ s

$t_{IEsc}$  is also measured under the condition: begin of short circuit to GND till error flag set.

d)  $IXX = H$ , reset of error flag when error condition is not true.

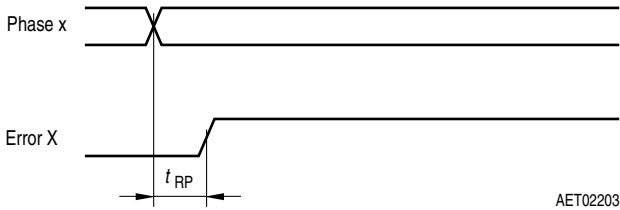

typ.  $t_{RP}$ : 3  $\mu$ s

e) Phase X = H or L, const.; reset of error flag when error condition is not true.

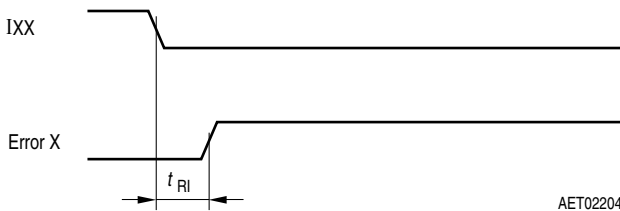

typ.  $t_{RI}$ : 1  $\mu$ s

**Quiescent Current  $I_S$  vs. Supply Voltage  $V_S$ ;**  
bridges not chopping;  $T_j = 25\text{ }^\circ\text{C}$

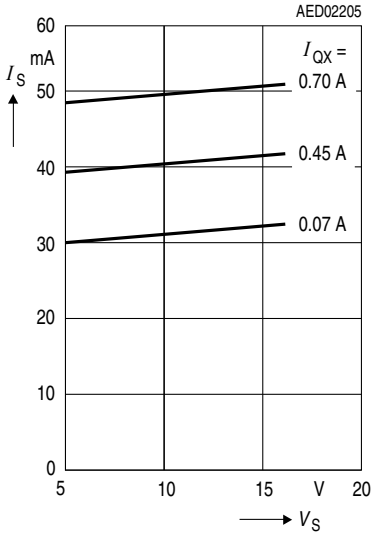

**Quiesc. Current  $I_S$  vs. Junct. Temp.  $T_j$ ;**  
bridges not chopping,  $V_S = 14\text{ V}$

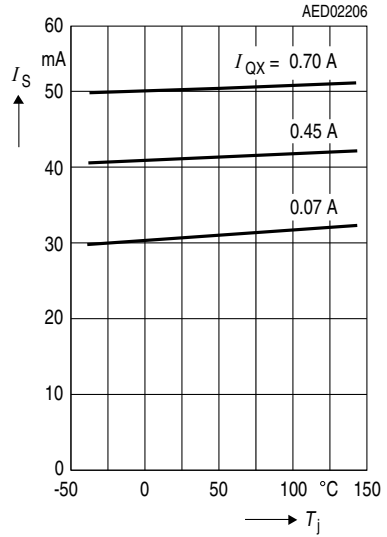

**Oscillator Frequency  $f_{Osc}$  vs. Junction Temperature  $T_j$**

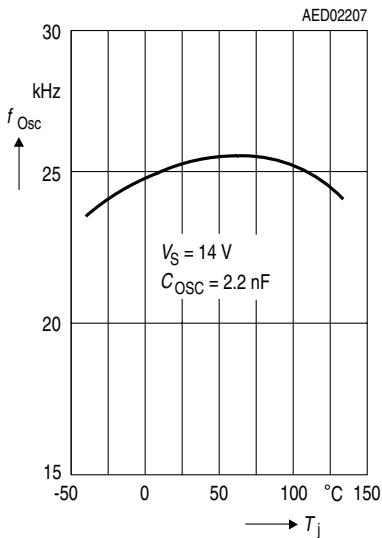

**Output Current  $I_{QX}$  vs. Junction Temperature  $T_j$**

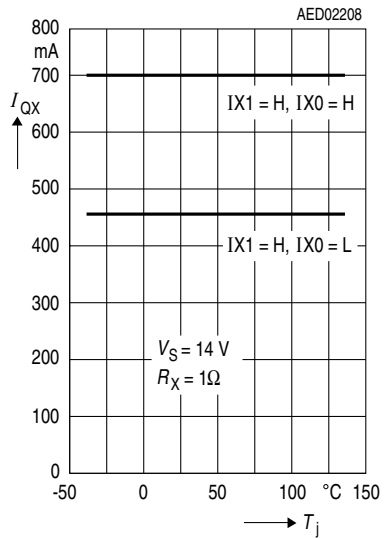

**Output Saturation Voltages  $V_{sat}$  vs. Output Current  $I_Q$**

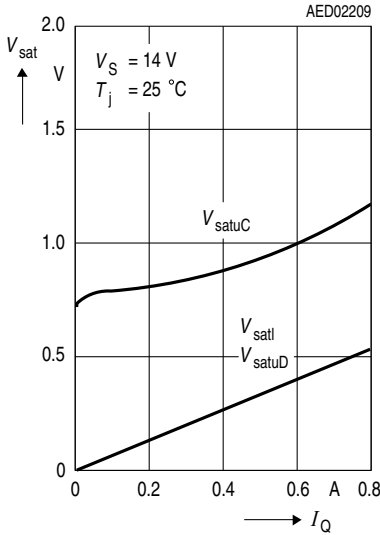

**Forward Current  $I_F$  of Free-Wheeling Diodes vs. Forward Voltages  $V_F$**

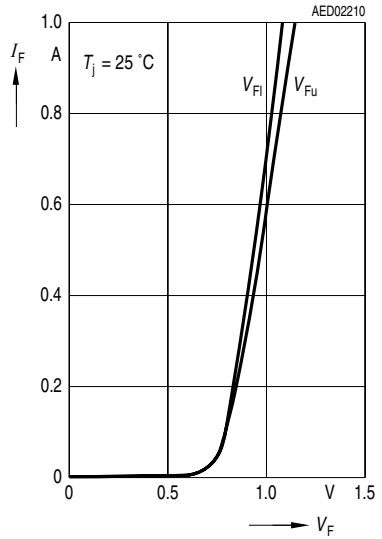

**Typical Power Dissipation  $P_{tot}$  vs. Output Current  $I_Q$  (non stepping)**

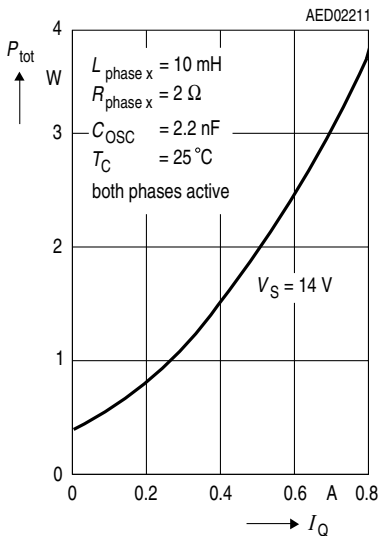

**Permissible Power Dissipation  $P_{tot}$  vs. Case Temp.  $T_C$  (measured at pin 5)**

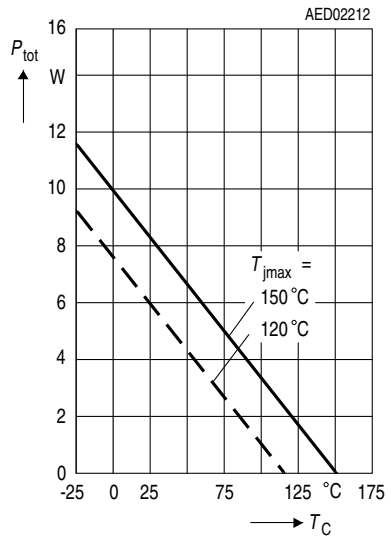

**Input Characteristics of  $I_{XX}$ , Phase X**

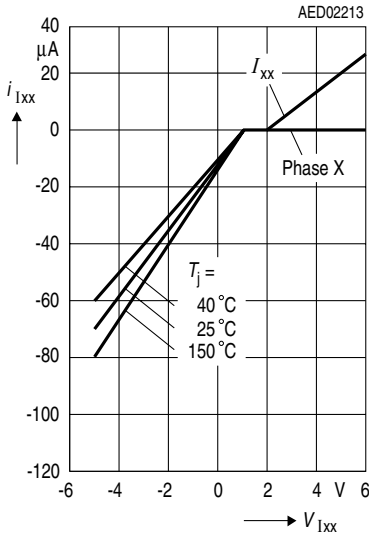

**Output Leakage Current**

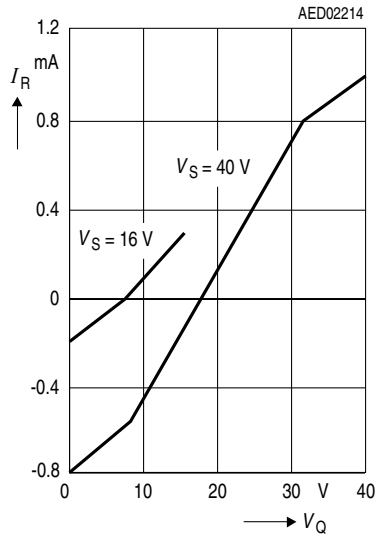

**Quiescent Current  $I_S$  vs. Supply Voltage  $V_S$ ;**  
inhibit mode;  $T_j = 25\text{ }^\circ\text{C}$

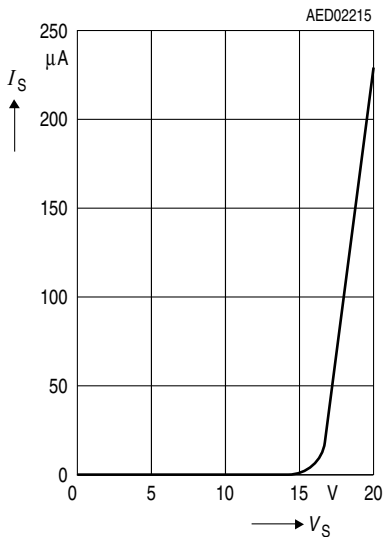

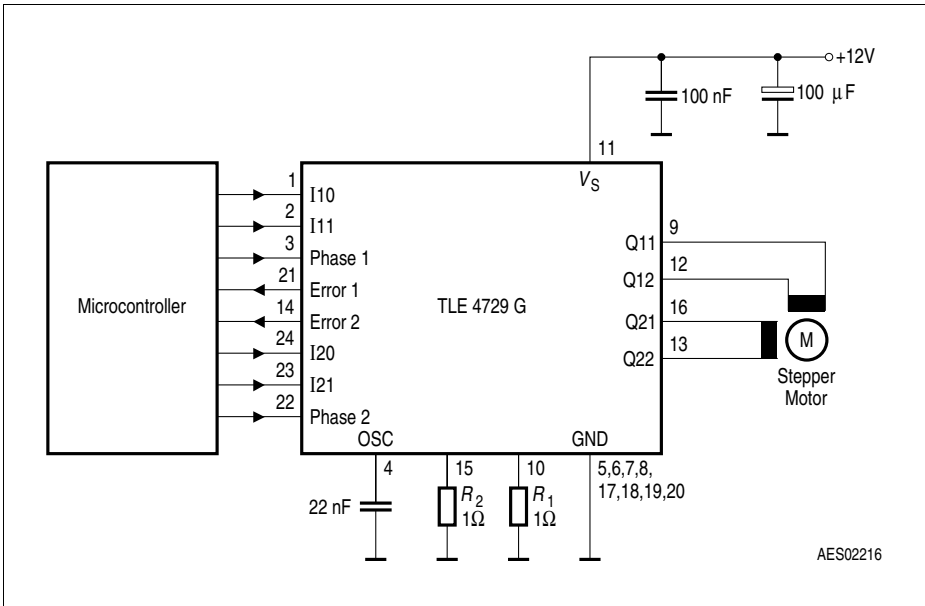
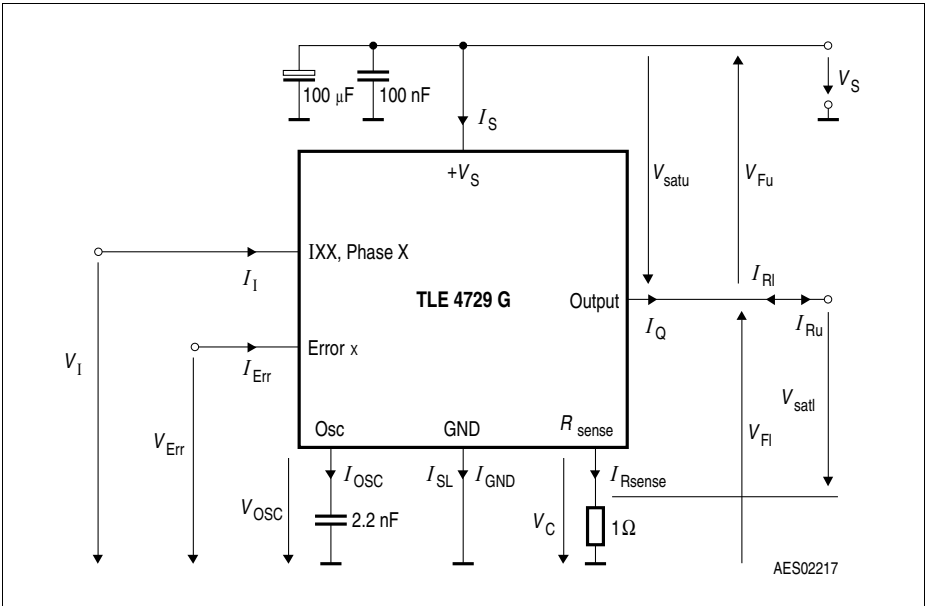
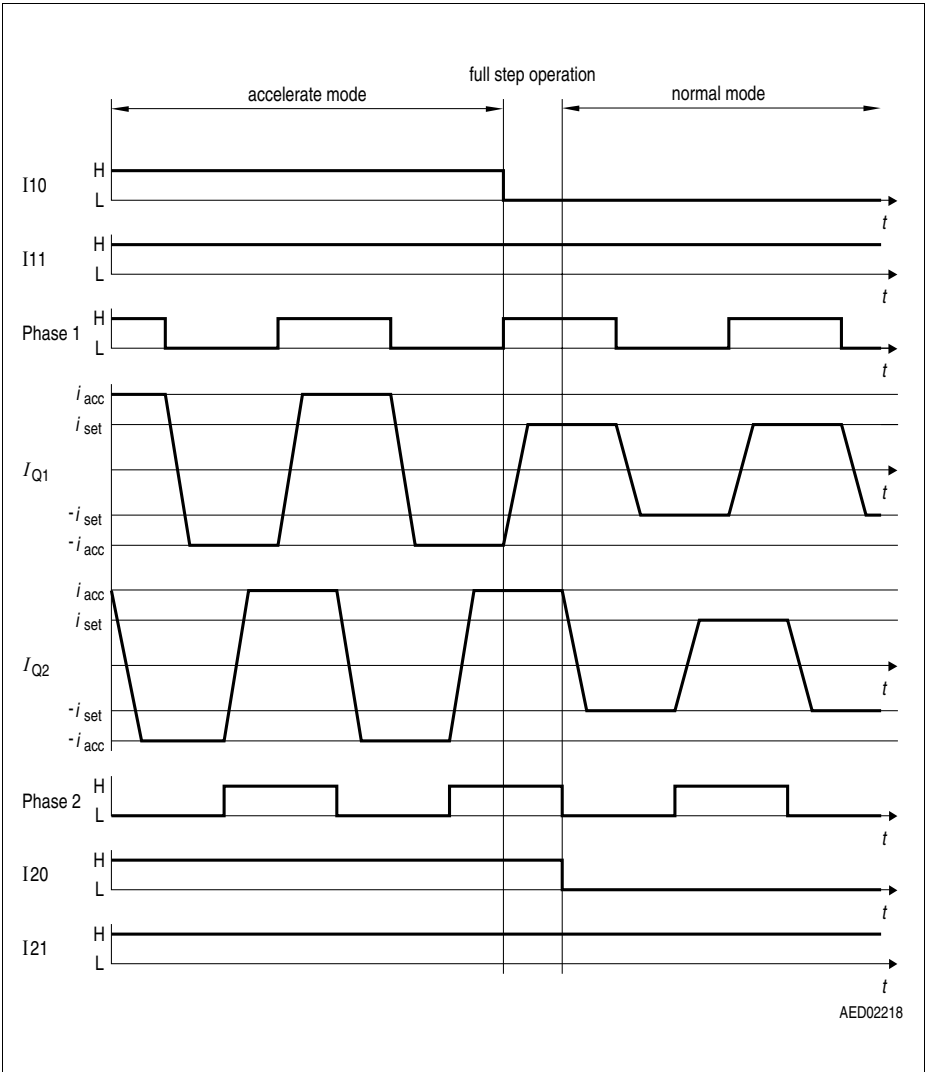

Figure 3 Application Circuit

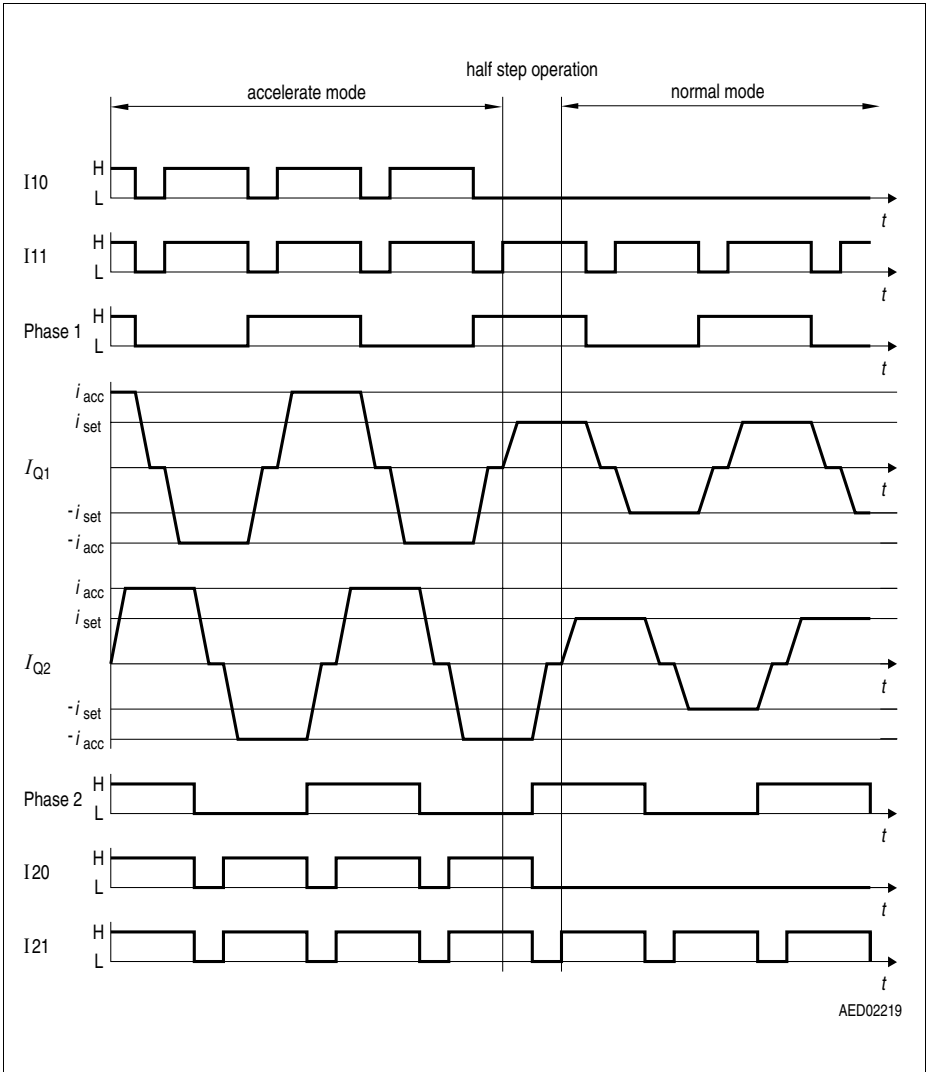



**Figure 4 Test Circuit**



**Figure 5 Full Step Operation**



**Figure 6 Half Step Operation**

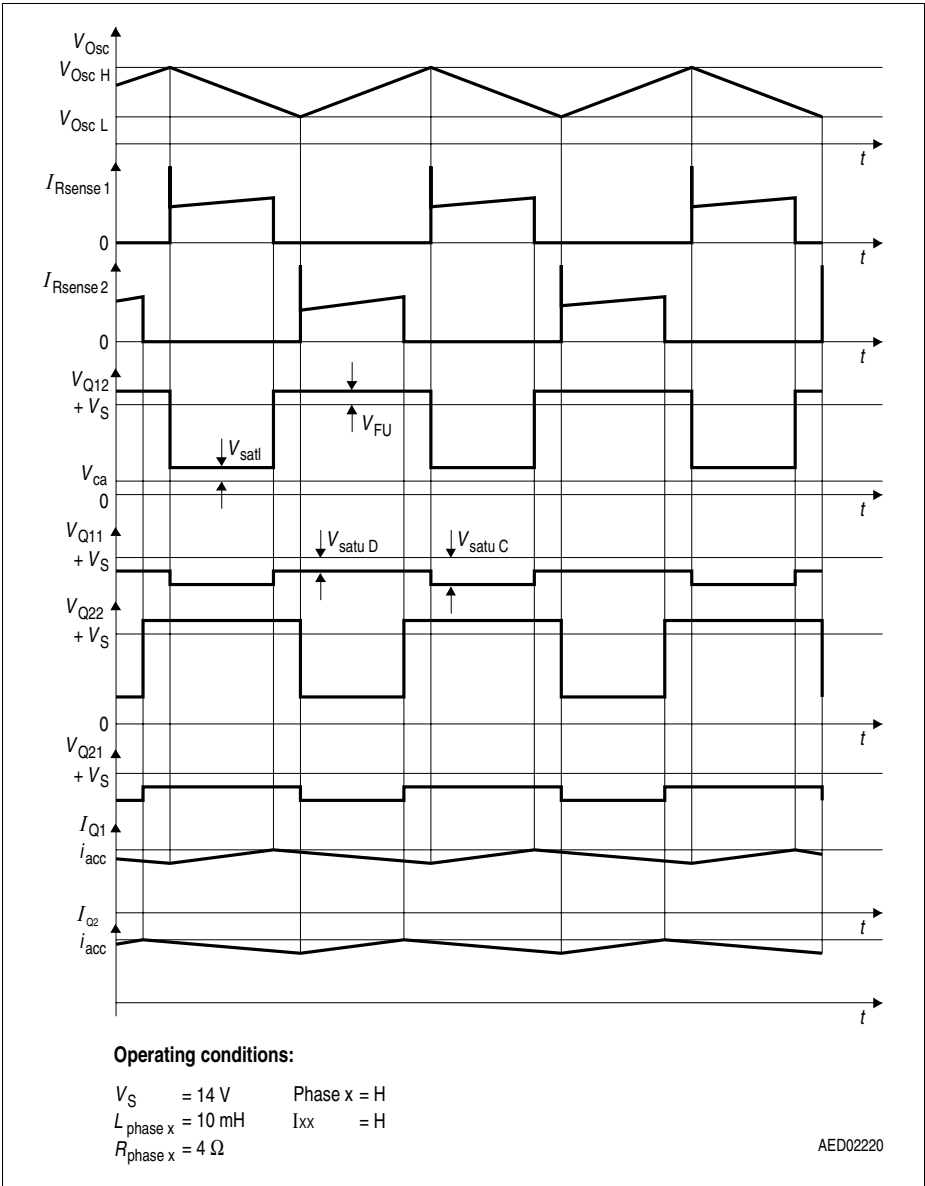

**Figure 7** Current Control in Chop-Mode

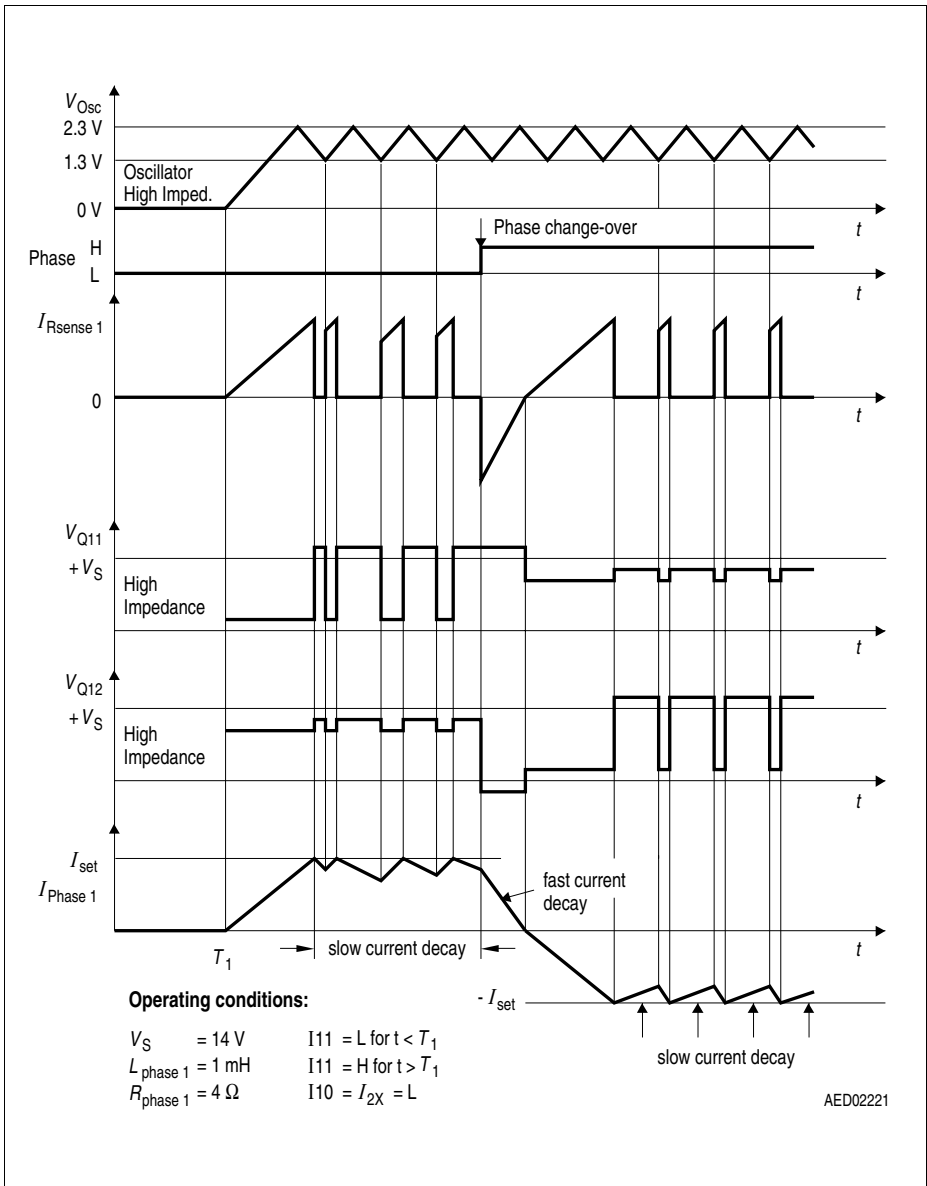

**Figure 8 Phase Reversal and Inhibit**

### Calculation of Power Dissipation

The total power dissipation  $P_{\text{tot}}$  is made up of

- Saturation losses  $P_{\text{sat}}$  (transistor saturation voltage and diode forward voltages),
- Quiescent losses  $P_{\text{q}}$  (quiescent current times supply voltage) and
- Switching losses  $P_{\text{s}}$  (turn-ON / turn-OFF operations).

The following equations give the power dissipation for chopper operation without phase reversal.

This is the worst case, because full current flows for the entire time and switching losses occur in addition.

$$P_{\text{tot}} = 2 \times P_{\text{sat}} + P_{\text{q}} + 2 \times P_{\text{s}}$$

where

$$P_{\text{sat}} \cong I_{\text{N}} \{V_{\text{satl}} \times d + V_{\text{Fu}} (1 - d) + V_{\text{satuC}} \times d + V_{\text{satuD}} (1 - d)\}$$

$$P_{\text{q}} = I_{\text{q}} \times V_{\text{S}}$$

$$P_{\text{s}} \cong \frac{V_{\text{S}}}{T} \left\{ \frac{i_{\text{D}} \times t_{\text{DON}}}{2} + \frac{(i_{\text{D}} + i_{\text{R}}) \times t_{\text{ON}}}{4} + \frac{I_{\text{N}}}{2} (t_{\text{DOFF}} + t_{\text{OFF}}) \right\}$$

$I_{\text{N}}$  = Nominal current (mean value)

$I_{\text{q}}$  = Quiescent current

$i_{\text{D}}$  = Reverse current during turn-on delay

$i_{\text{R}}$  = Peak reverse current

$t_{\text{p}}$  = Conducting time of chopper transistor

$t_{\text{ON}}$  = Turn-ON time

$t_{\text{OFF}}$  = Turn-OFF time

$t_{\text{DON}}$  = Turn-ON delay

$t_{\text{DOFF}}$  = Turn-OFF delay

$T$  = Cycle duration

$d$  = Duty cycle  $t_{\text{p}} / T$

$V_{\text{satl}}$  = Saturation voltage of sink transistor (TX3, TX4)

$V_{\text{satuC}}$  = Saturation voltage of source transistor (TX1, TX2) during charge cycle

$V_{\text{satuD}}$  = Saturation voltage of source transistor (TX1, TX2) during discharge cycle

$V_{\text{Fu}}$  = Forward voltage of free-wheeling diode (DX1, DX2)

$V_{\text{S}}$  = Supply voltage

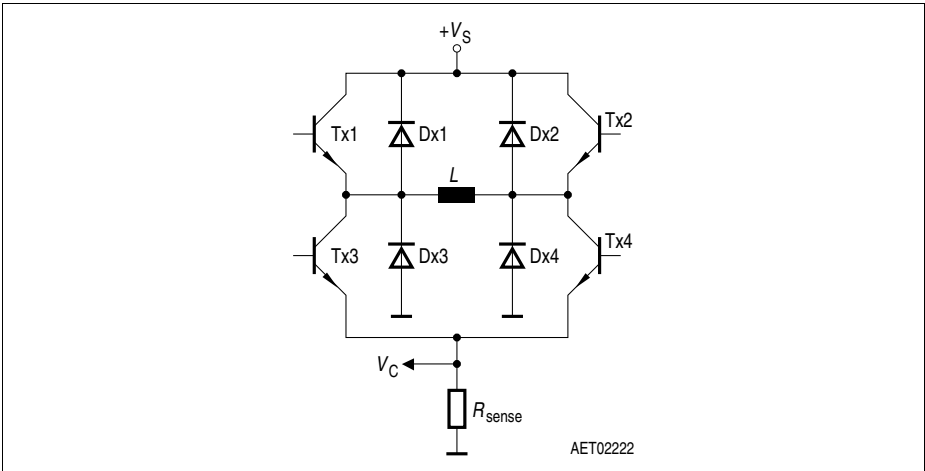

Figure 9

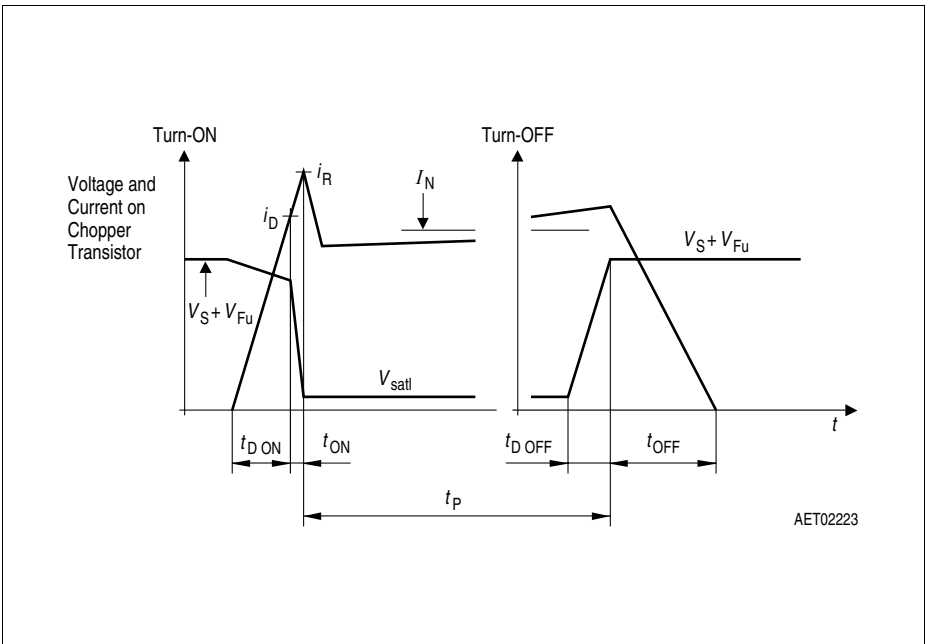

Figure 10 Voltage and Current on Chopper Transistor

## Application Hints

The TLE4729G is intended to drive both phases of a stepper motor. Special care has been taken to provide high efficiency, robustness and to minimize external components.

## Power Supply

The TLE4729G will work with supply voltages ranging from 5 V to 16 V at pin  $V_S$ . Surges exceeding 16 V at  $V_S$  won't harm the circuit up to 45 V, but whole function is not guaranteed. As soon as the voltage drops below approximately 16 V the TLE4729G works promptly again.

As the circuit operates with chopper regulation of the current, interference generation problems can arise in some applications. Therefore the power supply should be decoupled by a 0.1  $\mu\text{F}$  ceramic capacitor located near the package. Unstabilized supplies may even afford higher capacities.

## Inhibit Mode

In the case of low at all four current program inputs IXX the device will switch into inhibit condition; the current consumption is reduced to very low values.

When starting operation again, i.e. putting at least one IXX to high potential, the Error 1 output signals an open load error if the corresponding phase input is high. The error is reset by first recirculation in chop mode.

## Current Sensing

The current in the windings of the stepper motor is sensed by the voltage drop across  $R_{\text{sense}}$ . Depending on the selected current internal comparators will turn off the sink transistor as soon as the voltage drop reaches certain thresholds (typical 0 V, 0.07 V, 0.45 V and 0.7 V). These thresholds are not affected by variations of  $V_S$ . Consequently unstabilized supplies will not affect the performance of the regulation. For precise current level it must be considered, that internal bounding wire (typ. 60 m $\Omega$ ) is a part of  $R_{\text{sense}}$ .

Due to chopper control fast current rises (up to 10 A/ $\mu\text{s}$ ) will occur at the sensing resistors. To prevent malfunction of the current sensing mechanism  $R_{\text{sense}}$  should be pure ohmic. The resistors should be wired to GND as directly as possible. Capacitive loads such as long cables (with high wire to wire capacity) to the motor should be avoided for the same reason.

## Synchronizing Several Choppers

In some applications synchronic chopping of several stepper motor drivers may be desirable to reduce acoustic interference. This can be done by forcing the oscillator of the TLE4729G by a pulse generator overdriving the oscillator loading currents (approximately  $\pm 120 \mu\text{A}$ ). In these applications low level should be between 0 V and 0.8 V while high level should be between 3 V and 5 V.



## Application Hints (cont'd)

### Optimizing Noise Immunity

Unused inputs should always be wired to proper voltage levels in order to obtain highest possible noise immunity.

To prevent crossconduction of the output stages the TLE4729G uses a special break before make timing of the power transistors. This timing circuit can be triggered by short glitches (some hundred nanoseconds) at the phase inputs causing the output stage to become high resistive during some microseconds. This will lead to a fast current decay during that time. To achieve maximum current accuracy such glitches at the phase inputs should be avoided by proper control signals.

To lower EMI a ceramic capacitor of max. 3 nF is advisable from each output to GND.

### Thermal Shut Down

To protect the circuit against thermal destruction, thermal shut down has been implemented.

### Error Monitoring

The error outputs signal corresponding to the logic table the errors described below.

### Logic Table

Kind of Error		Error Output	
		Error 1	Error 2
a)	No error	H	H
b)	Short circuit to GND	H	L
c)	Open load <sup>1)</sup>	L	H
d)	b) and c) simultaneously	H	L
e)	Temperature prealarm	L	L

<sup>1)</sup> Also possible: short circuit to + V<sub>S</sub> or short circuit of the load.

**Over-Temperature** is implemented as pre-alarm; it appears approximately 20 K before thermal shut down. To detect an **open load**, the recirculation of the inductive load is watched. If there is no recirculation after a phase change-over, an internal error flipflop is set. Because in most kinds of **short circuits** there won't flow any current through the motor, there will be no recirculation after a phase change-over, and the error flipflop for open load will be set, too. Additionally an **open load error** is signaled after a phase change-over during hold mode.

Only in the case of a **short circuit to GND**, the most probably kind of a short circuit in automotive applications, the malfunction is signaled dominant (see d) in logic table) by a separate error flag. Simultaneously the output current is disabled after 30  $\mu\text{s}$  to prevent disturbances.

A phase change-over or putting both current control inputs of the affected bridge on low potential resets the error flipflop. Being a separate flipflop for every bridge, the error can be located in easy way.

Package Outlines

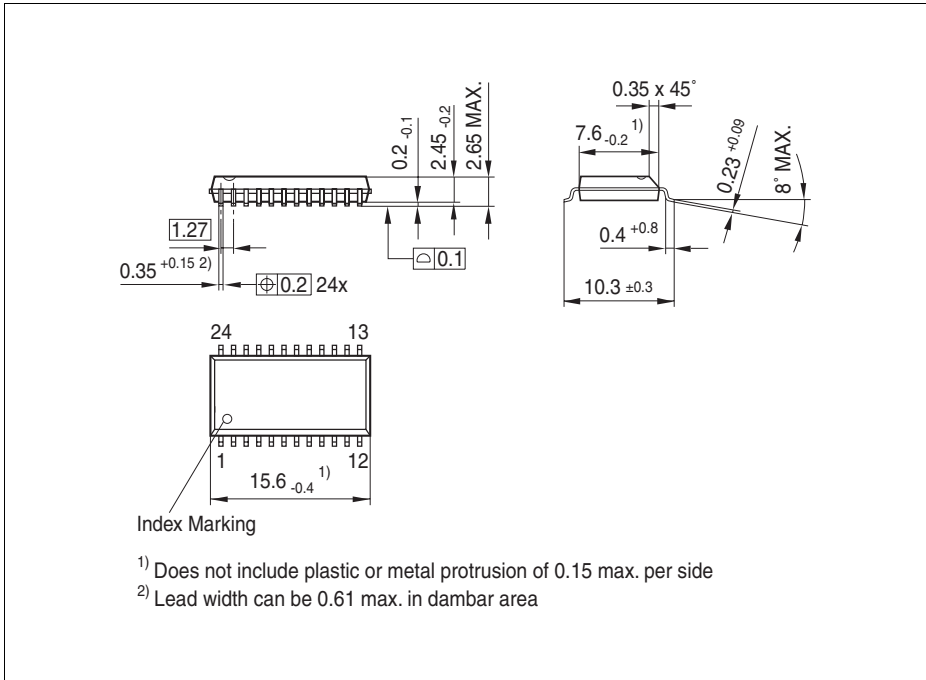

Figure 11 PG-DSO-24-16 (Plastic Green Dual Small Outline)

Green Product (RoHS compliant)

To meet the world-wide customer requirements for environmentally friendly products and to be compliant with government regulations the device is available as a green product. Green products are RoHS-Compliant (i.e Pb-free finish on leads and suitable for Pb-free soldering according to IPC/JEDEC J-STD-020).

You can find all of our packages, sorts of packing and others in our Infineon Internet Page “Products”: <http://www.infineon.com/products>.

SMD = Surface Mounted Device

Dimensions in mm

**Revision History**

<b>Version</b>	<b>Date</b>	<b>Changes</b>
Rev. 1.1	2007-09-17	<p>RoHS-compliant version of the TLE 4729 G</p> <ul style="list-style-type: none"> <li>• All pages: Infineon logo updated</li> <li>• Page 2:               <p>“added AEC qualified” and “RoHS” logo, “Green Product (RoHS compliant)” and “AEC qualified” statement added to feature list, package name changed to RoHS compliant versions, package picture updated, ordering code removed</p> </li> <li>• Page 27:               <p>Package name changed to RoHS compliant versions, “Green Product” description added</p> </li> <li>• added Revision History</li> <li>• added Legal Disclaimer</li> </ul>
Rev. 1.2	2008-03-18	<ul style="list-style-type: none"> <li>• Update Package suffix</li> </ul>

**Edition V1.2, 2008-03-18**

**Published by  
Infineon Technologies AG  
81726 Munich, Germany**

**© 2008 Infineon Technologies AG  
All Rights Reserved.**

#### **Legal Disclaimer**

The information given in this document shall in no event be regarded as a guarantee of conditions or characteristics. With respect to any examples or hints given herein, any typical values stated herein and/or any information regarding the application of the device, Infineon Technologies hereby disclaims any and all warranties and liabilities of any kind, including without limitation, warranties of non-infringement of intellectual property rights of any third party.

#### **Information**

For further information on technology, delivery terms and conditions and prices, please contact the nearest Infineon Technologies Office ([www.infineon.com](http://www.infineon.com)).

#### **Warnings**

Due to technical requirements, components may contain dangerous substances. For information on the types in question, please contact the nearest Infineon Technologies Office.

Infineon Technologies components may be used in life-support devices or systems only with the express written approval of Infineon Technologies, if a failure of such components can reasonably be expected to cause the failure of that life-support device or system or to affect the safety or effectiveness of that device or system. Life support devices or systems are intended to be implanted in the human body or to support and/or maintain and sustain and/or protect human life. If they fail, it is reasonable to assume that the health of the user or other persons may be endangered.

# Mouser Electronics

Authorized Distributor

Click to View Pricing, Inventory, Delivery & Lifecycle Information:

[Infineon:](#)

[TLE4729G](#)