

SMPS IGBT

IRGB20B60PD1PbF

WARP2 SERIES IGBT WITH
ULTRAFAST SOFT RECOVERY DIODE

Applications

- Telecom and Server SMPS
- PFC and ZVS SMPS Circuits
- Uninterruptable Power Supplies
- Consumer Electronics Power Supplies
- Lead-Free

Features

- NPT Technology, Positive Temperature Coefficient
- Lower $V_{CE(SAT)}$
- Lower Parasitic Capacitances
- Minimal Tail Current
- HEXFRED Ultra Fast Soft-Recovery Co-Pack Diode
- Tighter Distribution of Parameters
- Higher Reliability

Benefits

- Parallel Operation for Higher Current Applications
- Lower Conduction Losses and Switching Losses
- Higher Switching Frequency up to 150kHz

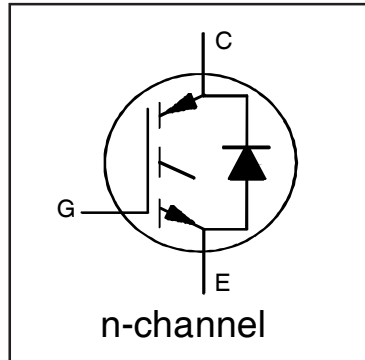

$V_{CES} = 600V$
$V_{CE(on)} \text{ typ.} = 2.05V$ @ $V_{GE} = 15V$ $I_C = 13.0A$
Equivalent MOSFET Parameters ①
$R_{CE(on)} \text{ typ.} = 158m\Omega$
I_D (FET equivalent) = 20A

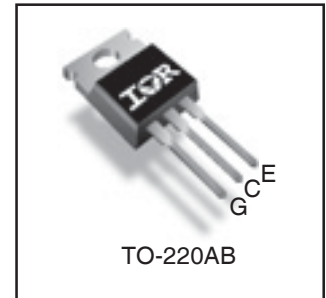

Absolute Maximum Ratings

	Parameter	Max.	Units
V_{CES}	Collector-to-Emitter Voltage	600	V
$I_C @ T_C = 25^\circ C$	Continuous Collector Current	40	A
$I_C @ T_C = 100^\circ C$	Continuous Collector Current	22	
I_{CM}	Pulse Collector Current (Ref. Fig. C.T.4)	80	
I_{LM}	Clamped Inductive Load Current ②	80	
$I_F @ T_C = 25^\circ C$	Diode Continuous Forward Current	10	
$I_F @ T_C = 100^\circ C$	Diode Continuous Forward Current	4	
I_{FRM}	Maximum Repetitive Forward Current ③	16	
V_{GE}	Gate-to-Emitter Voltage	± 20	
$P_D @ T_C = 25^\circ C$	Maximum Power Dissipation	215	W
$P_D @ T_C = 100^\circ C$	Maximum Power Dissipation	86	
T_J	Operating Junction and	-55 to +150	$^\circ C$
T_{STG}	Storage Temperature Range		
	Soldering Temperature, for 10 sec.		
	Mounting Torque, 6-32 or M3 Screw	10 lbf-in (1.1 N·m)	

Thermal Resistance

	Parameter	Min.	Typ.	Max.	Units
$R_{\theta JC}$ (IGBT)	Thermal Resistance Junction-to-Case-(each IGBT)	—	—	0.58	$^\circ C/W$
$R_{\theta JC}$ (Diode)	Thermal Resistance Junction-to-Case-(each Diode)	—	—	5.0	
$R_{\theta CS}$	Thermal Resistance, Case-to-Sink (flat, greased surface)	—	0.50	—	
$R_{\theta JA}$	Thermal Resistance, Junction-to-Ambient (typical socket mount)	—	—	80	
	Weight	—	2 (0.07)	—	g (oz)

IRGB20B60PD1PbF

Electrical Characteristics @ T_J = 25°C (unless otherwise specified)

International
 Rectifier

	Parameter	Min.	Typ.	Max.	Units	Conditions	Ref.Fig
V _{(BR)CES}	Collector-to-Emitter Breakdown Voltage	600	—	—	V	V _{GE} = 0V, I _C = 500μA	
ΔV _{(BR)CES} /ΔT _J	Temperature Coeff. of Breakdown Voltage	—	0.32	—	V/°C	V _{GE} = 0V, I _C = 1mA (25°C-125°C)	
R _G	Internal Gate Resistance	—	4.3	—	Ω	1MHz, Open Collector	
V _{CE(on)}	Collector-to-Emitter Saturation Voltage	—	2.05	2.35	V	I _C = 13A, V _{GE} = 15V	4, 5,6,8,9
		—	2.50	2.80		I _C = 20A, V _{GE} = 15V	
		—	2.65	3.00		I _C = 13A, V _{GE} = 15V, T _J = 125°C	
		—	3.30	3.70		I _C = 20A, V _{GE} = 15V, T _J = 125°C	
V _{GE(th)}	Gate Threshold Voltage	3.0	4.0	5.0	V	I _C = 250μA	7,8,9
ΔV _{GE(th)} /ΔT _J	Threshold Voltage temp. coefficient	—	-11	—	mV/°C	V _{CE} = V _{GE} , I _C = 1.0mA	
g _f	Forward Transconductance	—	19	—	S	V _{CE} = 50V, I _C = 40A, PW = 80μs	
I _{CES}	Collector-to-Emitter Leakage Current	—	1.0	250	μA	V _{GE} = 0V, V _{CE} = 600V	
		—	0.1	—	mA	V _{GE} = 0V, V _{CE} = 600V, T _J = 125°C	
V _{FM}	Diode Forward Voltage Drop	—	1.5	1.8	V	I _F = 4.0A, V _{GE} = 0V	10
		—	1.4	1.7		I _F = 4.0A, V _{GE} = 0V, T _J = 125°C	
I _{GES}	Gate-to-Emitter Leakage Current	—	—	±100	nA	V _{GE} = ±20V, V _{CE} = 0V	

Switching Characteristics @ T_J = 25°C (unless otherwise specified)

	Parameter	Min.	Typ.	Max.	Units	Conditions	Ref.Fig
Q _g	Total Gate Charge (turn-on)	—	68	102	nC	I _C = 13A	17
Q _{gc}	Gate-to-Collector Charge (turn-on)	—	24	36		V _{CC} = 400V	CT1
Q _{ge}	Gate-to-Emitter Charge (turn-on)	—	10	15		V _{GE} = 15V	
E _{on}	Turn-On Switching Loss	—	95	140	μJ	I _C = 13A, V _{CC} = 390V	CT3
E _{off}	Turn-Off Switching Loss	—	100	145		V _{GE} = +15V, R _G = 10Ω, L = 200μH	
E _{total}	Total Switching Loss	—	195	285		T _J = 25°C ④	
t _{d(on)}	Turn-On delay time	—	20	26	ns	I _C = 13A, V _{CC} = 390V	CT3
t _r	Rise time	—	5.0	7.0		V _{GE} = +15V, R _G = 10Ω, L = 200μH	
t _{d(off)}	Turn-Off delay time	—	115	135		T _J = 25°C ④	
t _f	Fall time	—	6.0	8.0			
E _{on}	Turn-On Switching Loss	—	165	215		I _C = 13A, V _{CC} = 390V	
E _{off}	Turn-Off Switching Loss	—	150	195	μJ	V _{GE} = +15V, R _G = 10Ω, L = 200μH	11,13
E _{total}	Total Switching Loss	—	315	410		T _J = 125°C ④	WF1,WF2
t _{d(on)}	Turn-On delay time	—	19	25		I _C = 13A, V _{CC} = 390V	CT3
t _r	Rise time	—	6.0	8.0	ns	V _{GE} = +15V, R _G = 10Ω, L = 200μH	12,14
t _{d(off)}	Turn-Off delay time	—	125	140		T _J = 125°C ④	WF1,WF2
t _f	Fall time	—	13	17			
C _{ies}	Input Capacitance	—	1560	—		pF	V _{GE} = 0V
C _{oes}	Output Capacitance	—	95	—	V _{CC} = 30V		15
C _{res}	Reverse Transfer Capacitance	—	20	—	f = 1Mhz		
C _{oes eff.}	Effective Output Capacitance (Time Related) ⑤	—	83	—	V _{GE} = 0V, V _{CE} = 0V to 480V		
C _{oes eff. (ER)}	Effective Output Capacitance (Energy Related) ⑤	—	61	—			
RBSOA	Reverse Bias Safe Operating Area	FULL SQUARE				T _J = 150°C, I _C = 80A V _{CC} = 480V, V _p = 600V R _g = 22Ω, V _{GE} = +15V to 0V	
t _{rr}	Diode Reverse Recovery Time	—	28	42	ns	T _J = 25°C I _F = 4.0A, V _R = 200V,	19
		—	38	57		T _J = 125°C di/dt = 200A/μs	
Q _{rr}	Diode Reverse Recovery Charge	—	40	60	nC	T _J = 25°C I _F = 4.0A, V _R = 200V,	21
		—	70	105		T _J = 125°C di/dt = 200A/μs	
I _{rr}	Peak Reverse Recovery Current	—	2.9	5.2	A	T _J = 25°C I _F = 4.0A, V _R = 200V,	19,20,21,22
		—	3.7	6.7		T _J = 125°C di/dt = 200A/μs	

Notes:

- ① R_{CE(on)} typ. = equivalent on-resistance = V_{CE(on)} typ. / I_C, where V_{CE(on)} typ. = 2.05V and I_C = 13A. I_D (FET Equivalent) is the equivalent MOSFET I_D rating @ 25°C for applications up to 150kHz. These are provided for comparison purposes (only) with equivalent MOSFET solutions.
- ② V_{CC} = 80% (V_{CES}), V_{GE} = 15V, L = 28μH, R_G = 22Ω.
- ③ Pulse width limited by max. junction temperature.
- ④ Energy losses include "tail" and diode reverse recovery. Data generated with use of Diode 8ETH06.
- ⑤ C_{oes eff.} is a fixed capacitance that gives the same charging time as C_{oes} while V_{CE} is rising from 0 to 80% V_{CES}.
C_{oes eff.(ER)} is a fixed capacitance that stores the same energy as C_{oes} while V_{CE} is rising from 0 to 80% V_{CES}.

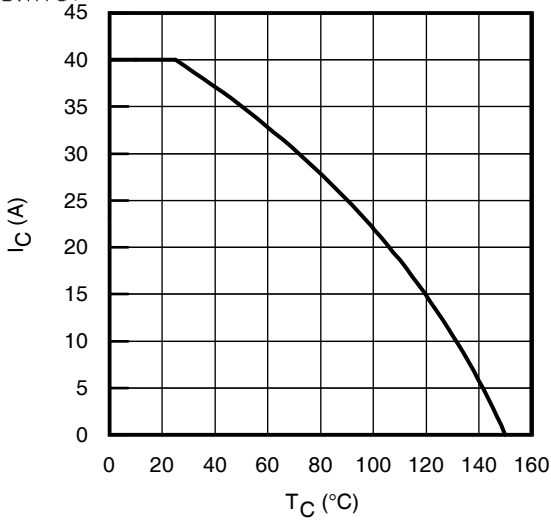

Fig. 1 - Maximum DC Collector Current vs. Case Temperature

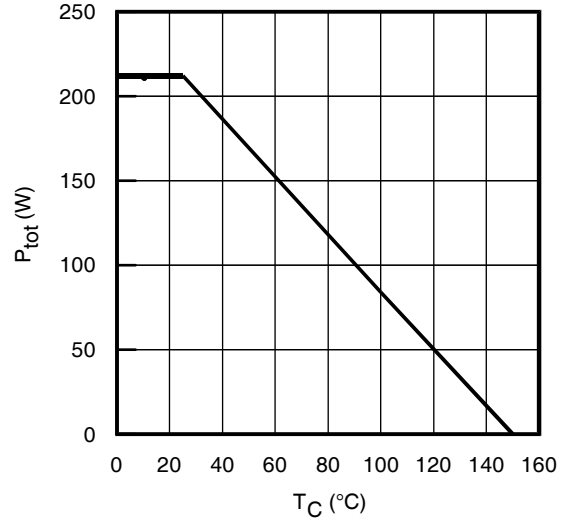

Fig. 2 - Power Dissipation vs. Case Temperature

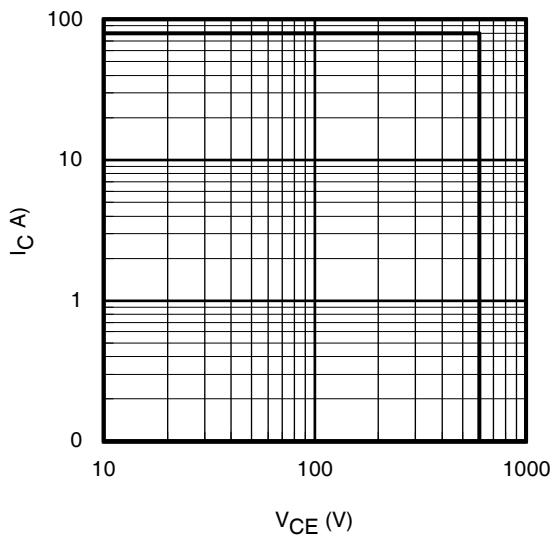

Fig. 3 - Reverse Bias SOA
 $T_J = 150^{\circ}C$; $V_{GE} = 15V$

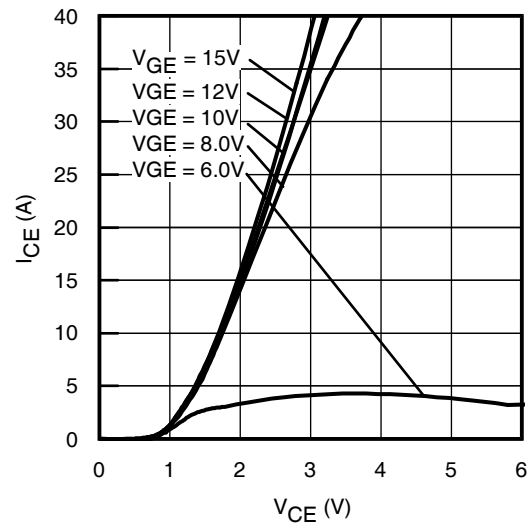

Fig. 4 - Typ. IGBT Output Characteristics
 $T_J = -40^{\circ}C$; $t_p = 80\mu s$

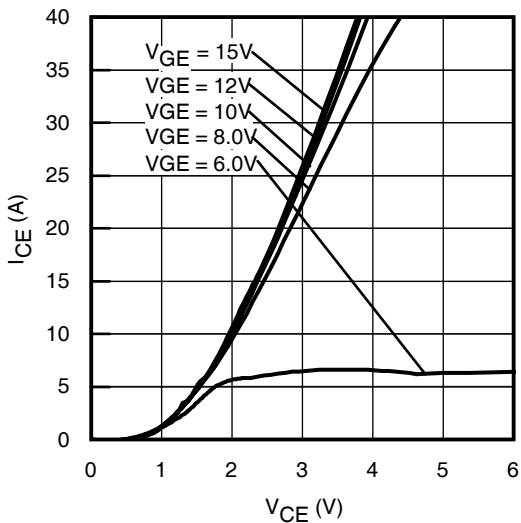

Fig. 5 - Typ. IGBT Output Characteristics
 $T_J = 25^{\circ}C$; $t_p = 80\mu s$

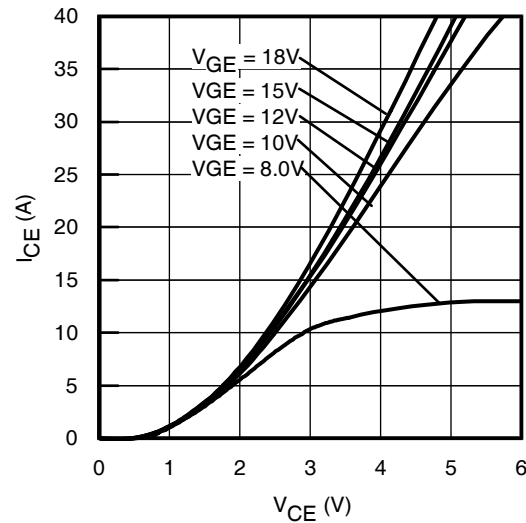

Fig. 6 - Typ. IGBT Output Characteristics
 $T_J = 125^{\circ}C$; $t_p = 80\mu s$

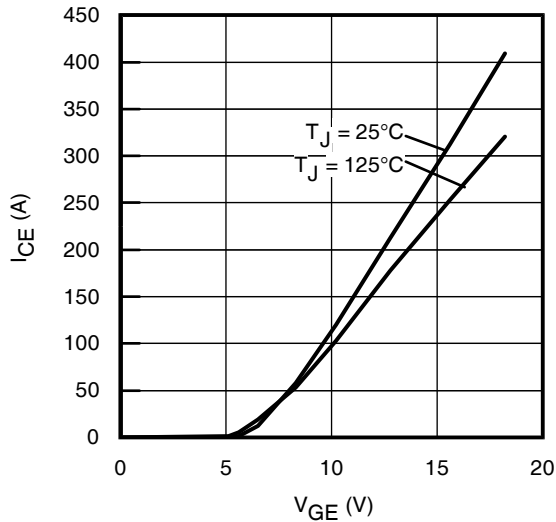

Fig. 7 - Typ. Transfer Characteristics
 $V_{CE} = 50V$; $t_p = 10\mu s$

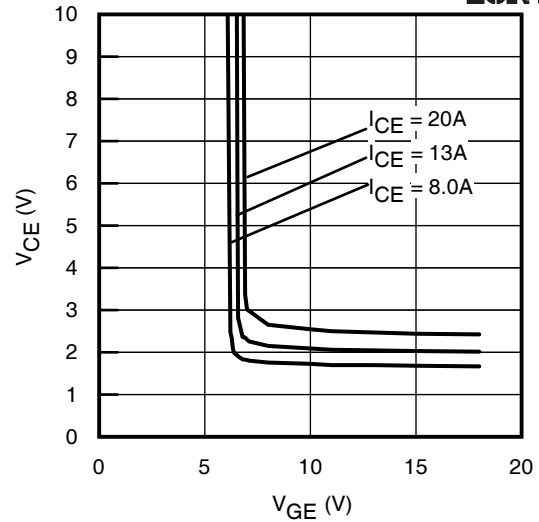

Fig. 8 - Typical V_{CE} vs. V_{GE}
 $T_J = 25^\circ C$

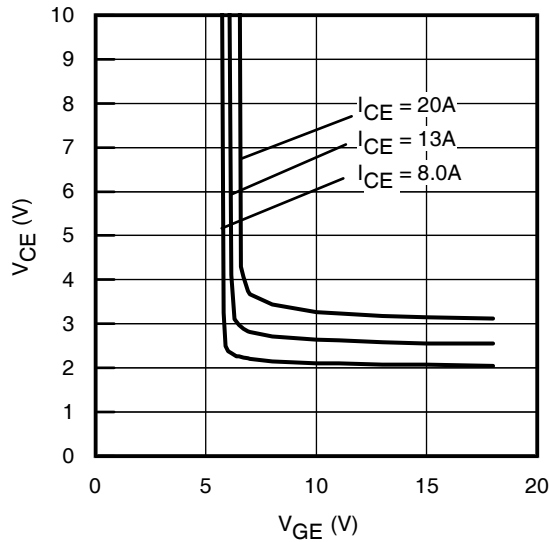

Fig. 9 - Typical V_{CE} vs. V_{GE}
 $T_J = 125^\circ C$

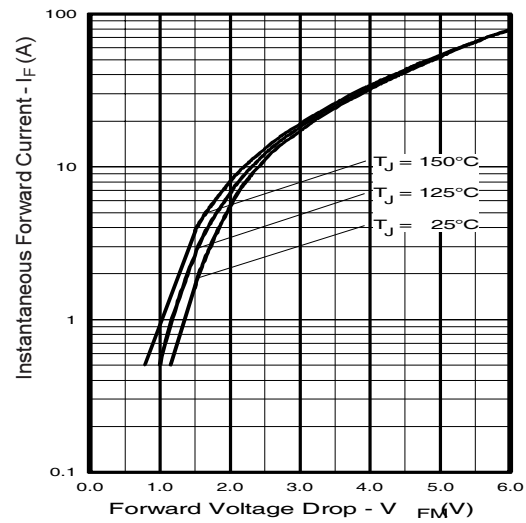

Fig. 10 - Typ. Diode Forward Characteristics
 $t_p = 80\mu s$

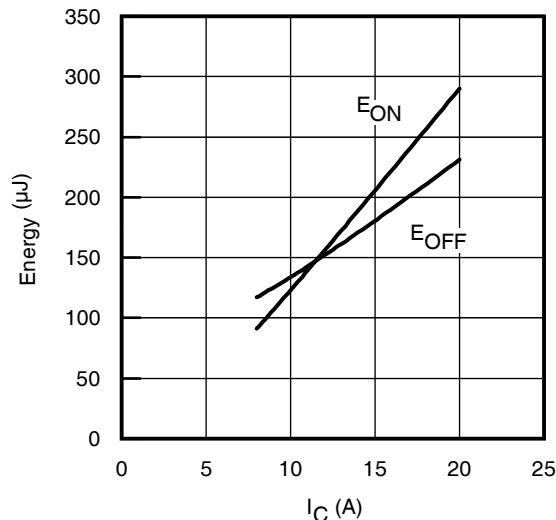

Fig. 11 - Typ. Energy Loss vs. I_C
 $T_J = 125^\circ C$; $L = 200\mu H$; $V_{CE} = 390V$; $R_G = 10\Omega$; $V_{GE} = 15V$.
Diode clamp used: 8ETH06 (See C.T.3)

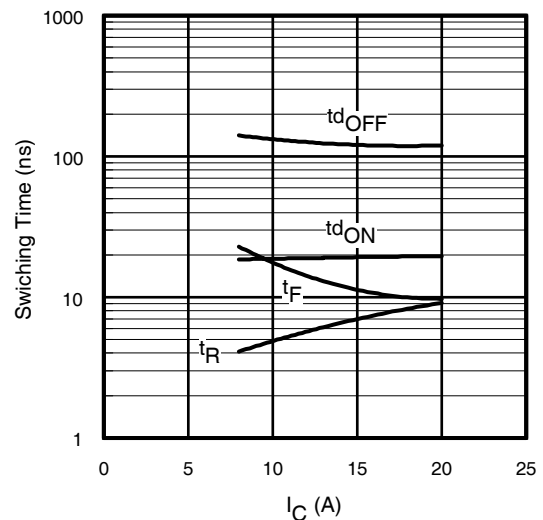

Fig. 12 - Typ. Switching Time vs. I_C
 $T_J = 125^\circ C$; $L = 200\mu H$; $V_{CE} = 390V$; $R_G = 10\Omega$; $V_{GE} = 15V$.
Diode clamp used: 8ETH06 (See C.T.3)

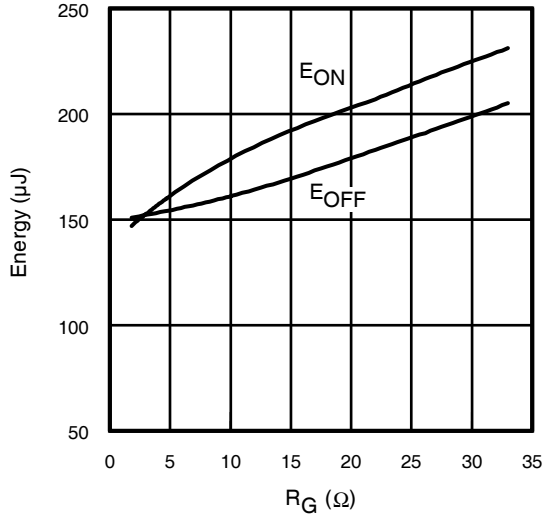

Fig. 13 - Typ. Energy Loss vs. R_G

$T_J = 125^\circ\text{C}$; $L = 200\mu\text{H}$; $V_{CE} = 390\text{V}$; $I_{CE} = 13\text{A}$; $V_{GE} = 15\text{V}$
Diode clamp used: 8ETH06 (See C.T.3)

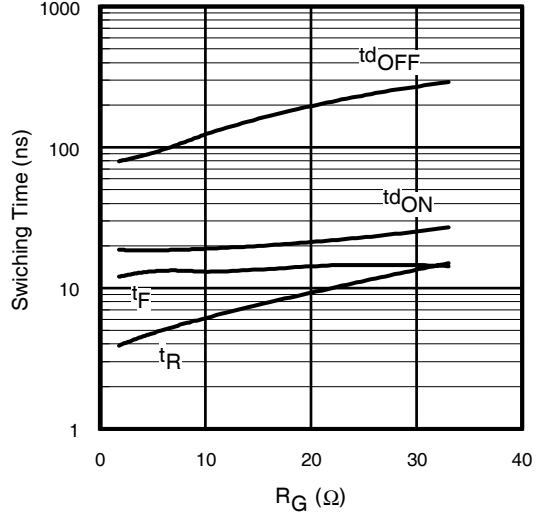

Fig. 14 - Typ. Switching Time vs. R_G

$T_J = 125^\circ\text{C}$; $L = 200\mu\text{H}$; $V_{CE} = 390\text{V}$; $I_{CE} = 13\text{A}$; $V_{GE} = 15\text{V}$
Diode clamp used: 8ETH06 (See C.T.3)

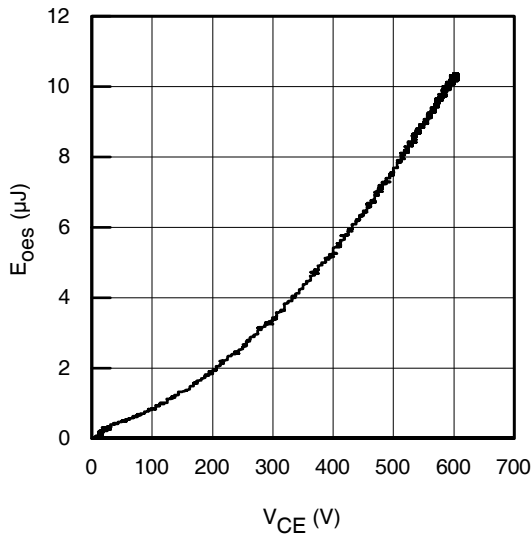

Fig. 15- Typ. Output Capacitance
Stored Energy vs. V_{CE}

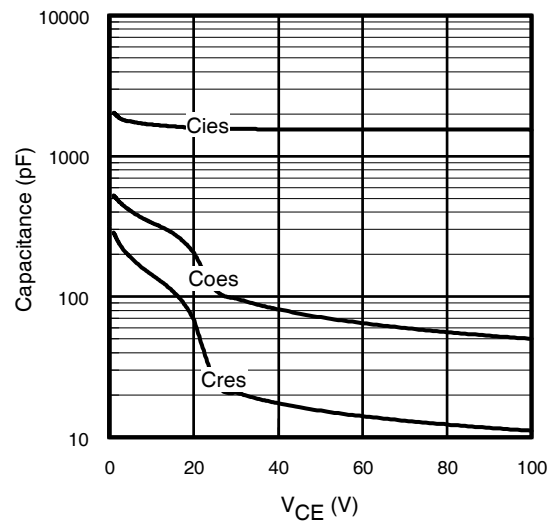

Fig. 16- Typ. Capacitance vs. V_{CE}
 $V_{GE} = 0\text{V}$; $f = 1\text{MHz}$

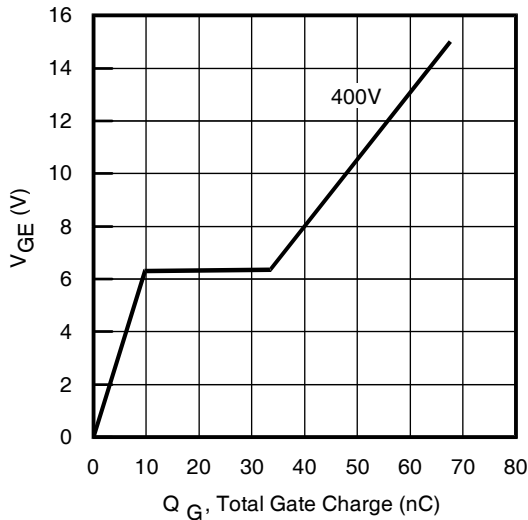

Fig. 17 - Typical Gate Charge vs. V_{GE}
 $I_{CE} = 13\text{A}$

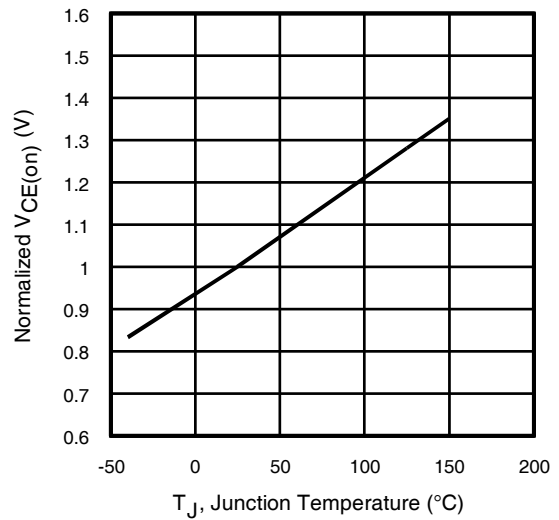

Fig. 18 - Normalized Typical $V_{CE(on)}$ vs.
Junction Temperature
 $I_{CE} = 13\text{A}$; $V_{GE} = 15\text{V}$

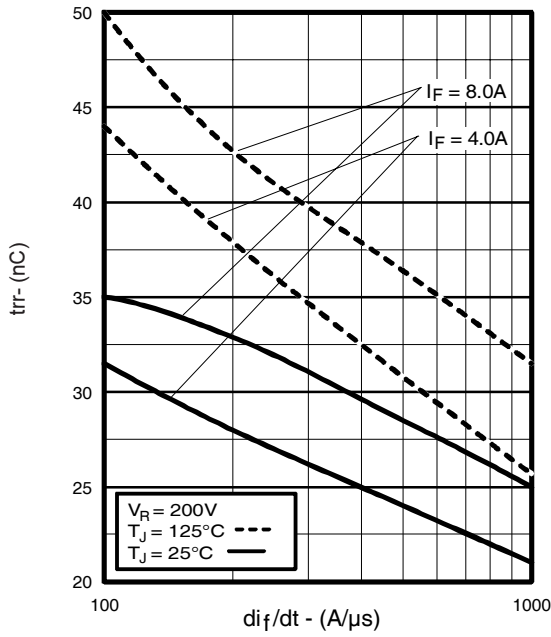

Fig. 19 - Typical Reverse Recovery vs. dI_f/dt

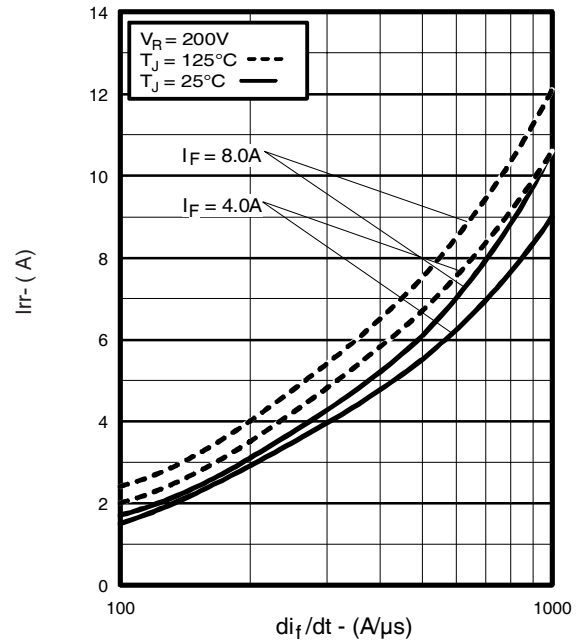

Fig. 20 - Typical Recovery Current vs. dI_f/dt

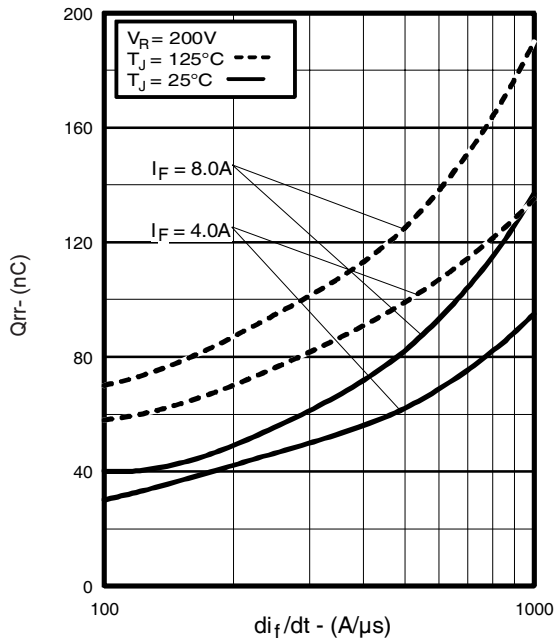

Fig. 21 - Typical Stored Charge vs. dI_f/dt

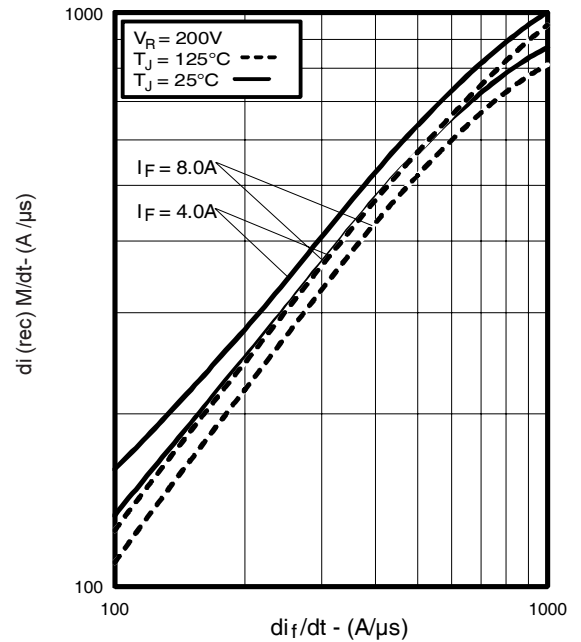

Fig. 22 - Typical $dI_{(rec)M}/dt$ vs. dI_f/dt ,

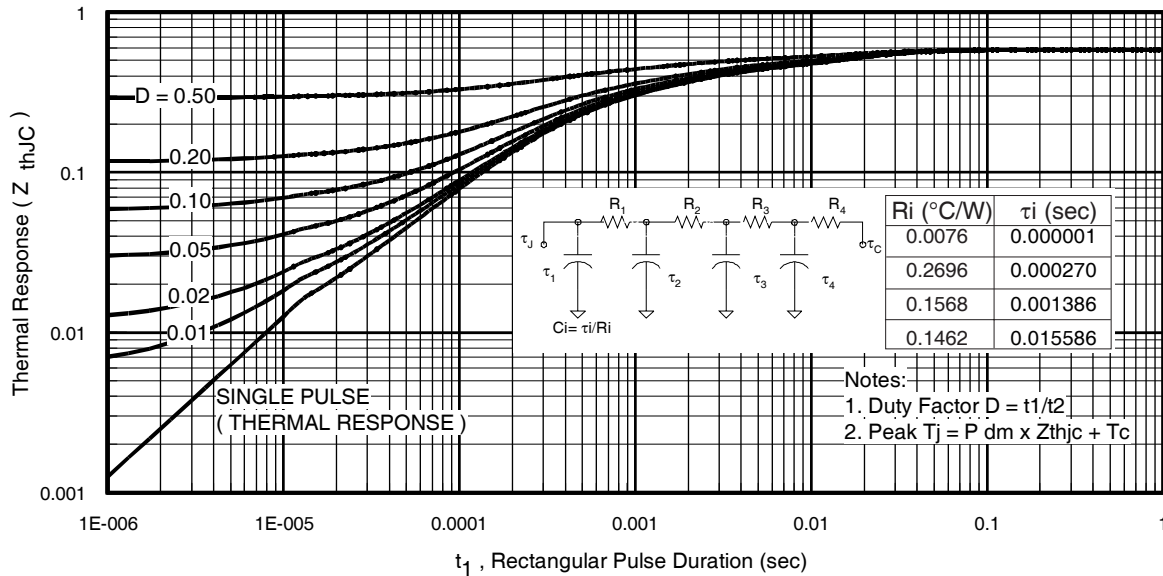

Fig 23. Maximum Transient Thermal Impedance, Junction-to-Case (IGBT)

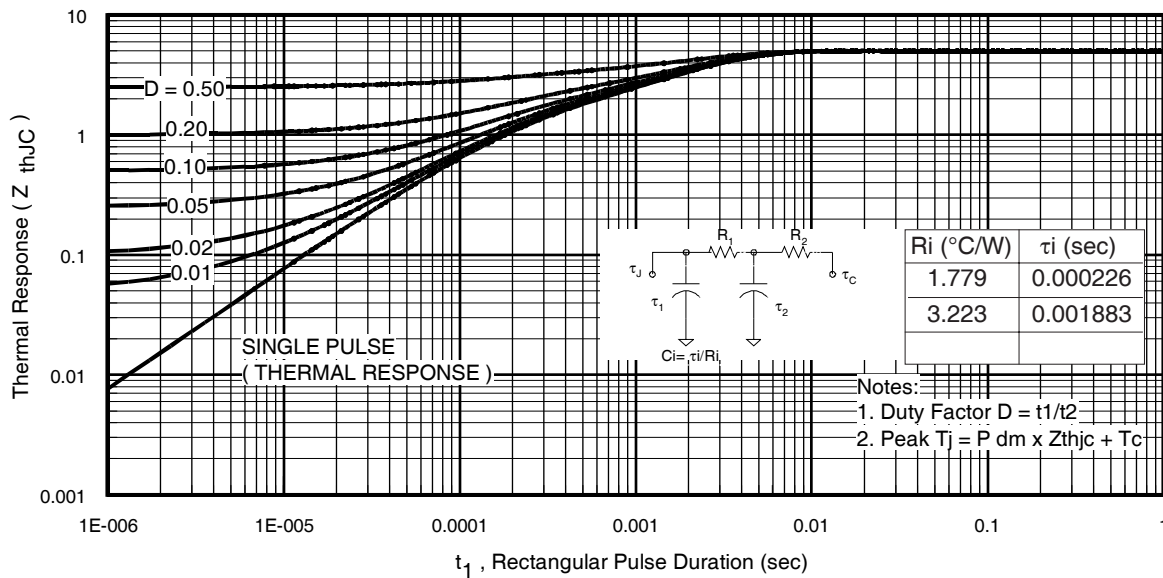

Fig. 24. Maximum Transient Thermal Impedance, Junction-to-Case (DIODE)

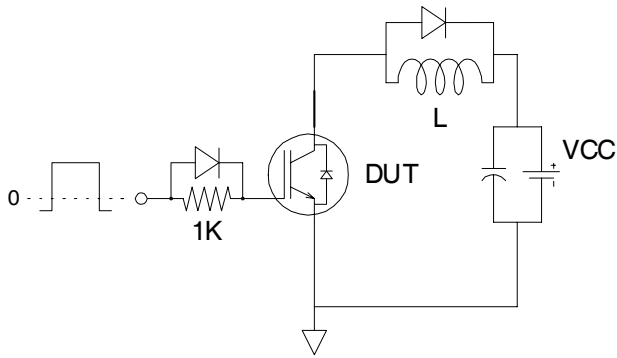

Fig.C.T.1 - Gate Charge Circuit (turn-off)

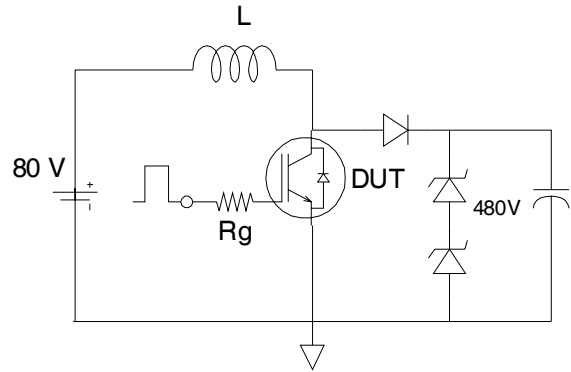

Fig.C.T.2 - RBSOA Circuit

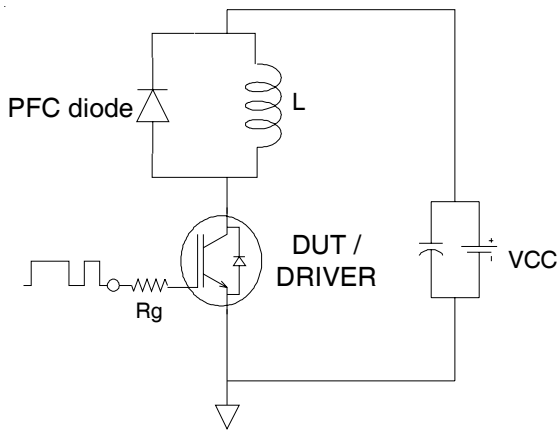

Fig.C.T.3 - Switching Loss Circuit

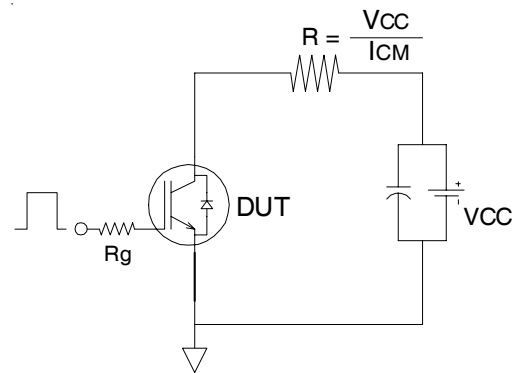

Fig.C.T.4 - Resistive Load Circuit

REVERSE RECOVERY CIRCUIT

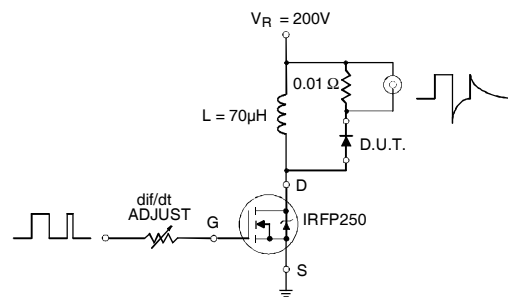

Fig. C.T.5 - Reverse Recovery Parameter Test Circuit

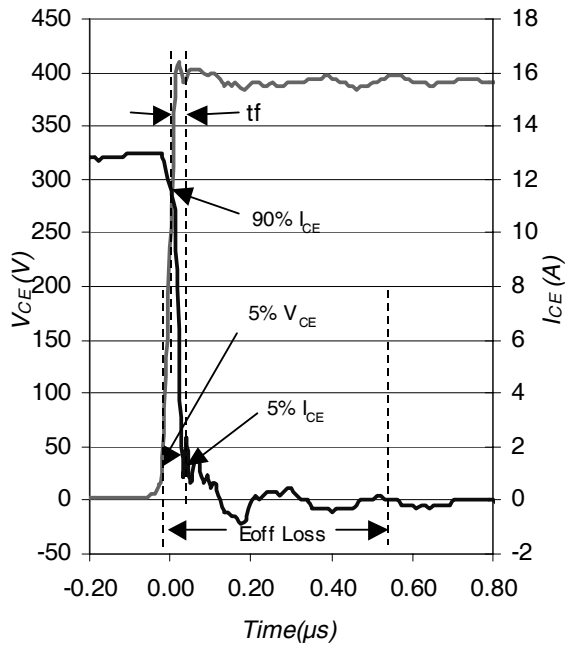

Fig. WF1 - Typ. Turn-off Loss Waveform
@ $T_J = 125^\circ\text{C}$ using Fig. CT.3

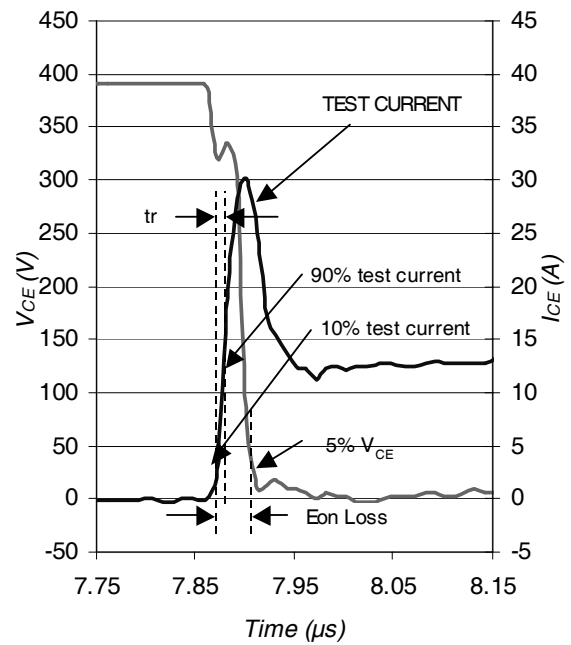

Fig. WF2 - Typ. Turn-on Loss Waveform
@ $T_J = 125^\circ\text{C}$ using Fig. CT.3

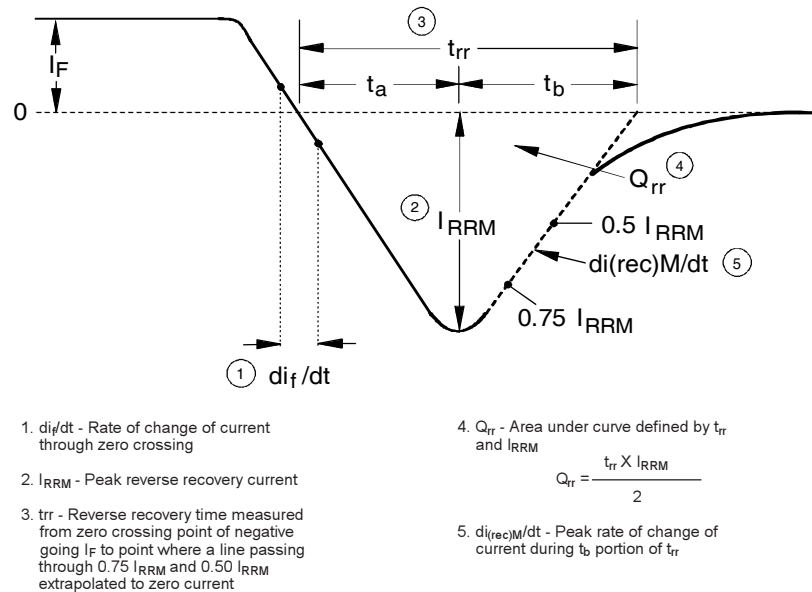
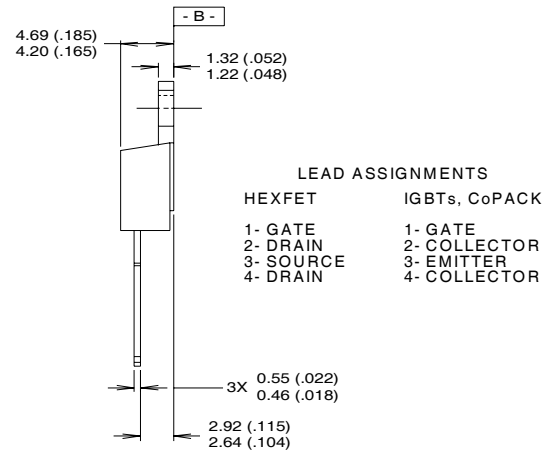
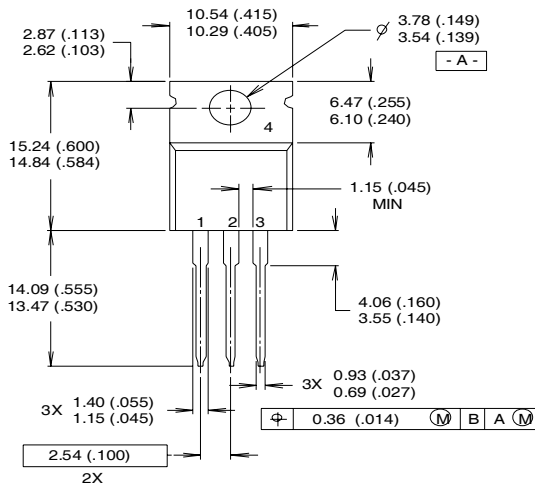

Fig. WF3 - Reverse Recovery Waveform and Definitions

TO-220AB Package Outline

Dimensions are shown in millimeters (inches)



NOTES:

- 1 DIMENSIONING & TOLERANCING PER ANSI Y14.5M, 1982.
- 2 CONTROLLING DIMENSION : INCH

- 3 OUTLINE CONFORMS TO JEDEC OUTLINE TO-220AB.
- 4 HEATSINK & LEAD MEASUREMENTS DO NOT INCLUDE BURRS.

TO-220AB Part Marking Information

EXAMPLE: THIS IS AN IRF1010
 LOT CODE 1789
 ASSEMBLED ON WW 19, 1997
 IN THE ASSEMBLY LINE "C"
Note: "P" in assembly line
 position indicates "Lead-Free"

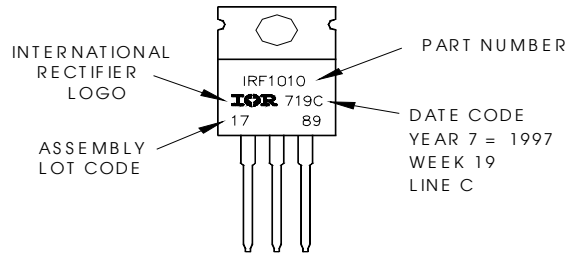

TO-220AB package is not recommended for Surface Mount Application.

Data and specifications subject to change without notice.
 This product has been designed and qualified for Industrial market.
 Qualification Standards can be found on IR's Web site.

Note: For the most current drawings please refer to the IR website at:
<http://www.irf.com/package/>

Mouser Electronics

Authorized Distributor

Click to View Pricing, Inventory, Delivery & Lifecycle Information:

[International Rectifier:](#)

[IRGB20B60PD1PBF](#)