

# Thyristor

$V_{RRM} = 1600\text{ V}$   
 $I_{TAV} = 30\text{ A}$   
 $V_T = 1,4\text{ V}$

Three Quadrants operation: QI - QIII  
 1~ Triac

Part number

**CMA60MT1600NHR**

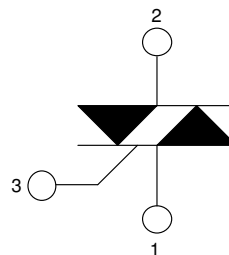
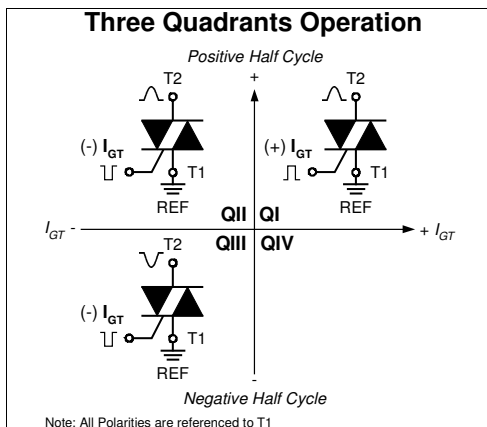
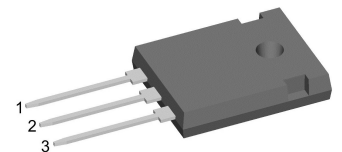

Backside: isolated



### Features / Advantages:

- Triac for line frequency
- Three Quadrants Operation - QI - QIII
- Planar passivated chip
- Long-term stability of blocking currents and voltages

### Applications:

- Line rectifying 50/60 Hz
- Softstart AC motor control
- DC Motor control
- Power converter
- AC power control
- Lighting and temperature control

### Package: ISO247

- Isolation Voltage: 3600 V~
- Industry standard outline
- RoHS compliant
- Epoxy meets UL 94V-0
- Soldering pins for PCB mounting
- Backside: DCB ceramic
- Reduced weight
- Advanced power cycling

### Terms Conditions of usage:

The data contained in this product data sheet is exclusively intended for technically trained staff. The user will have to evaluate the suitability of the product for the intended application and the completeness of the product data with respect to his application. The specifications of our components may not be considered as an assurance of component characteristics. The information in the valid application- and assembly notes must be considered. Should you require product information in excess of the data given in this product data sheet or which concerns the specific application of your product, please contact the sales office, which is responsible for you.

Due to technical requirements our product may contain dangerous substances. For information on the types in question please contact the sales office, which is responsible for you.

Should you intend to use the product in aviation, in health or live endangering or life support applications, please notify. For any such application we urgently recommend

- to perform joint risk and quality assessments;

- the conclusion of quality agreements;

- to establish joint measures of an ongoing product survey, and that we may make delivery dependent on the realization of any such measures.

Rectifier				Ratings			
Symbol	Definition	Conditions	min.	typ.	max.	Unit	
$V_{RSM/DSM}$	max. non-repetitive reverse/forward blocking voltage	$T_{VJ} = 25^{\circ}C$			1700	V	
$V_{RRM/DRM}$	max. repetitive reverse/forward blocking voltage	$T_{VJ} = 25^{\circ}C$			1600	V	
$I_{RD}$	reverse current, drain current	$V_{R/D} = 1600 V$	$T_{VJ} = 25^{\circ}C$		10	$\mu A$	
		$V_{R/D} = 1600 V$	$T_{VJ} = 125^{\circ}C$		2	mA	
$V_T$	forward voltage drop	$I_T = 30 A$	$T_{VJ} = 25^{\circ}C$		1,40	V	
		$I_T = 60 A$			1,77	V	
		$I_T = 30 A$	$T_{VJ} = 125^{\circ}C$		1,40	V	
		$I_T = 60 A$			1,88	V	
$I_{TAV}$	average forward current	$T_C = 90^{\circ}C$	$T_{VJ} = 150^{\circ}C$		30	A	
$I_{RMS}$	RMS forward current per phase	180° sine			66	A	
$V_{T0}$	threshold voltage	} for power loss calculation only	$T_{VJ} = 150^{\circ}C$		0,90	V	
$r_T$	slope resistance				16,6	m $\Omega$	
$R_{thJC}$	thermal resistance junction to case				0,9	K/W	
$R_{thCH}$	thermal resistance case to heatsink			0,25		K/W	
$P_{tot}$	total power dissipation		$T_C = 25^{\circ}C$		140	W	
$I_{TSM}$	max. forward surge current	$t = 10 ms; (50 Hz), sine$	$T_{VJ} = 45^{\circ}C$		260	A	
		$t = 8,3 ms; (60 Hz), sine$	$V_R = 0 V$		280	A	
		$t = 10 ms; (50 Hz), sine$	$T_{VJ} = 150^{\circ}C$		220	A	
		$t = 8,3 ms; (60 Hz), sine$	$V_R = 0 V$		240	A	
$I^2t$	value for fusing	$t = 10 ms; (50 Hz), sine$	$T_{VJ} = 45^{\circ}C$		340	A <sup>2</sup> s	
		$t = 8,3 ms; (60 Hz), sine$	$V_R = 0 V$		325	A <sup>2</sup> s	
		$t = 10 ms; (50 Hz), sine$	$T_{VJ} = 150^{\circ}C$		240	A <sup>2</sup> s	
		$t = 8,3 ms; (60 Hz), sine$	$V_R = 0 V$		240	A <sup>2</sup> s	
$C_J$	junction capacitance	$V_R = 400 V \quad f = 1 MHz$	$T_{VJ} = 25^{\circ}C$		9	pF	
$P_{GM}$	max. gate power dissipation	$t_p = 30 \mu s$	$T_C = 150^{\circ}C$		10	W	
		$t_p = 300 \mu s$			5	W	
$P_{GAV}$	average gate power dissipation				0,5	W	
$(di/dt)_{cr}$	critical rate of rise of current	$T_{VJ} = 125^{\circ}C; f = 50 Hz$ repetitive, $I_T = 90 A$			150	A/ $\mu s$	
		$t_p = 200 \mu s; di_G/dt = 0,2 A/\mu s;$ $I_G = 0,2 A; V = \frac{2}{3} V_{DRM}$ non-repet., $I_T = 30 A$			500	A/ $\mu s$	
$(dv/dt)_{cr}$	critical rate of rise of voltage	$V = \frac{2}{3} V_{DRM}$	$T_{VJ} = 125^{\circ}C$		500	V/ $\mu s$	
		$R_{GK} = \infty$ ; method 1 (linear voltage rise)					
$V_{GT}$	gate trigger voltage	$V_D = 6 V$	$T_{VJ} = 25^{\circ}C$		1,3	V	
			$T_{VJ} = -40^{\circ}C$		1,6	V	
$I_{GT}$	gate trigger current	$V_D = 6 V$	$T_{VJ} = 25^{\circ}C$		$\pm 60$	mA	
			$T_{VJ} = -40^{\circ}C$		$\pm 80$	mA	
$V_{GD}$	gate non-trigger voltage	$V_D = \frac{2}{3} V_{DRM}$	$T_{VJ} = 125^{\circ}C$		0,2	V	
$I_{GD}$	gate non-trigger current				$\pm 1$	mA	
$I_L$	latching current	$t_p = 10 \mu s$	$T_{VJ} = 25^{\circ}C$		90	mA	
		$I_G = 0,2 A; di_G/dt = 0,2 A/\mu s$					
$I_H$	holding current	$V_D = 6 V \quad R_{GK} = \infty$	$T_{VJ} = 25^{\circ}C$		60	mA	
$t_{gd}$	gate controlled delay time	$V_D = \frac{1}{2} V_{DRM}$	$T_{VJ} = 25^{\circ}C$		2	$\mu s$	
		$I_G = 0,5 A; di_G/dt = 0,5 A/\mu s$					
$t_q$	turn-off time	$V_R = 100 V; I_T = 30 A; V = \frac{2}{3} V_{DRM}$ $di/dt = 10 A/\mu s \quad dv/dt = 20 V/\mu s \quad t_p = 200 \mu s$	$T_{VJ} = 125^{\circ}C$		150	$\mu s$	

Package ISO247		Ratings				
Symbol	Definition	Conditions	min.	typ.	max.	Unit
$I_{RMS}$	RMS current	per terminal			70	A
$T_{VJ}$	virtual junction temperature		-55		150	°C
$T_{op}$	operation temperature		-55		125	°C
$T_{stg}$	storage temperature		-55		150	°C
<b>Weight</b>				6		g
$M_D$	mounting torque		0,8		1,2	Nm
$F_C$	mounting force with clip		20		120	N
$d_{Spp/ App}$	creepage distance on surface   striking distance through air	terminal to terminal	2,7			mm
$d_{Spb/ Apb}$		terminal to backside	4,1			mm
$V_{ISOL}$	isolation voltage	t = 1 second	3600			V
		t = 1 minute	3000			V

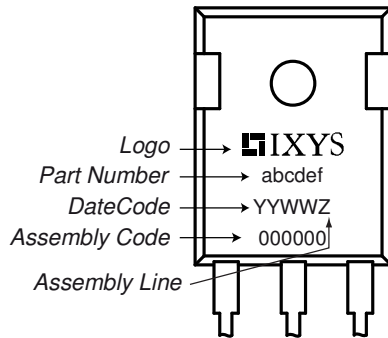
**Product Marking**

**Part description**

- C = Thyristor (SCR)
- M = Thyristor
- A = (up to 1800V)
- 60 = Current Rating [A]
- MT = 1~ Triac
- 1600 = Reverse Voltage [V]
- N = Three Quadrants operation: QI - QIII
- HR = ISO247 (3)

Ordering	Ordering Number	Marking on Product	Delivery Mode	Quantity	Code No.
Standard	CMA60MT1600NHR	CMA60MT1600NHR	Tube	30	517853

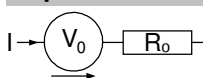
Similar Part	Package	Voltage class
CMA60MT1600NHB	TO-247AD (3)	1600

**Equivalent Circuits for Simulation**
*\* on die level*
 $T_{VJ} = 150\text{ °C}$ 

**Thyristor**

$V_{0\ max}$	threshold voltage	0,9	V
$R_{0\ max}$	slope resistance *	14,1	mΩ

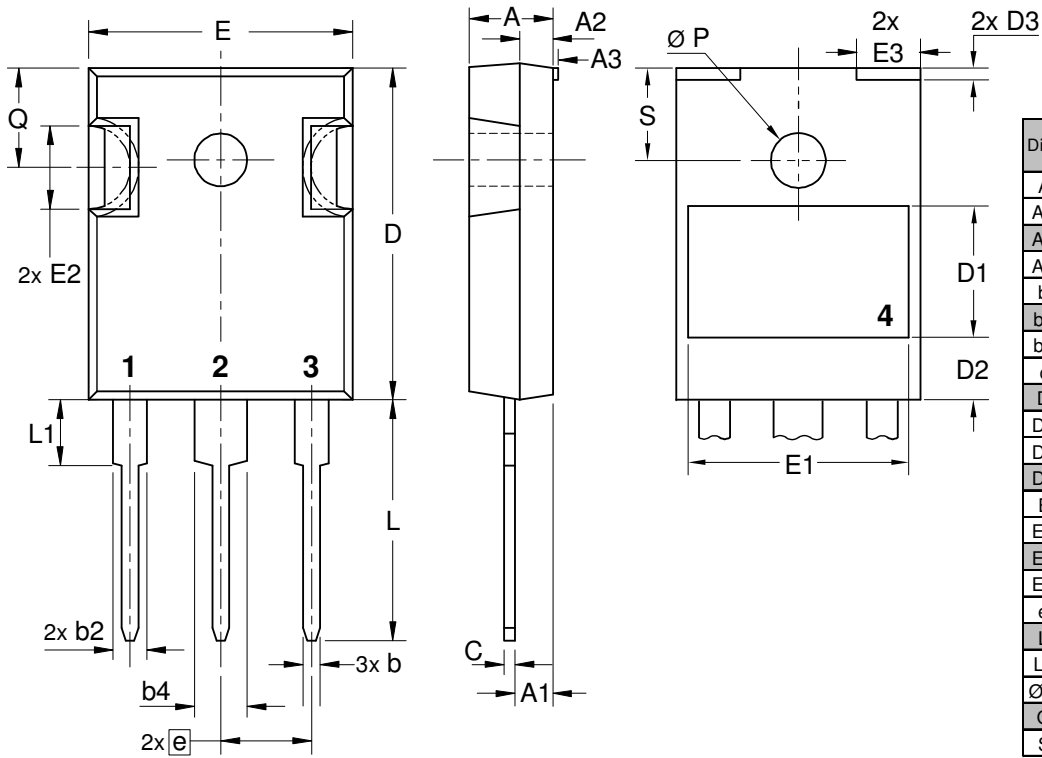
## Outlines ISO247

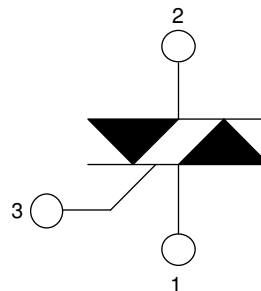

Dim.	Millimeter		Inches	
	min	max	min	max
A	4.70	5.30	0.185	0.209
A1	2.21	2.59	0.087	0.102
A2	1.50	2.49	0.059	0.098
A3	typ. 0.05		typ. 0.002	
b	0.99	1.40	0.039	0.055
b2	1.65	2.39	0.065	0.094
b4	2.59	3.43	0.102	0.135
c	0.38	0.89	0.015	0.035
D	20.79	21.45	0.819	0.844
D1	typ. 8.90		typ. 0.350	
D2	typ. 2.90		typ. 0.114	
D3	typ. 1.00		typ. 0.039	
E	15.49	16.24	0.610	0.639
E1	typ. 13.45		typ. 0.530	
E2	4.31	5.48	0.170	0.216
E3	typ. 4.00		typ. 0.157	
e	5.46 BSC		0.215 BSC	
L	19.80	20.30	0.780	0.799
L1	-	4.49	-	0.177
Ø P	3.55	3.65	0.140	0.144
Q	5.38	6.19	0.212	0.244
S	6.14 BSC		0.242 BSC	



## Thyristor

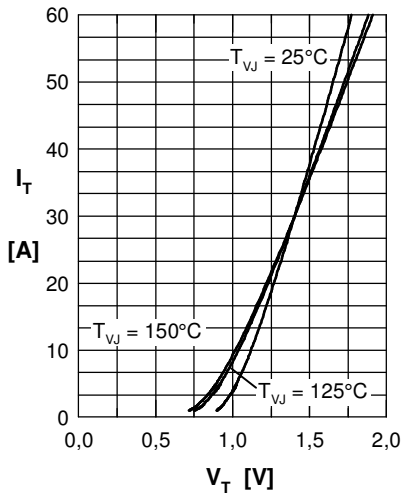

Fig. 1 Forward characteristics

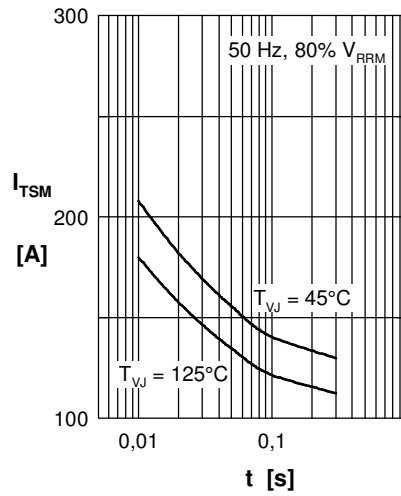

Fig. 2 Surge overload current  
 $I_{TSM}$ : crest value,  $t$ : duration

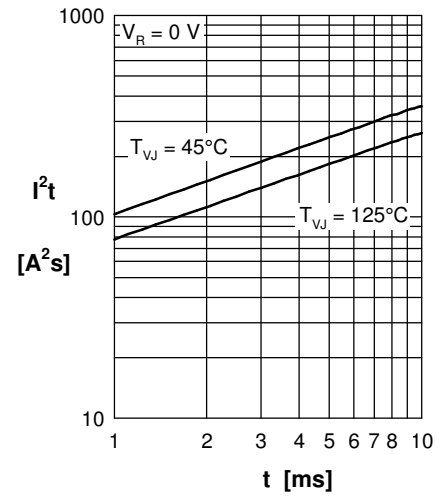

Fig. 3  $I^2t$  versus time (1-10 s)

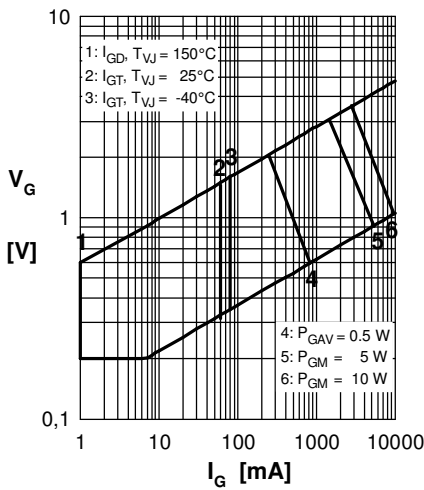

Fig. 4 Gate voltage & gate current

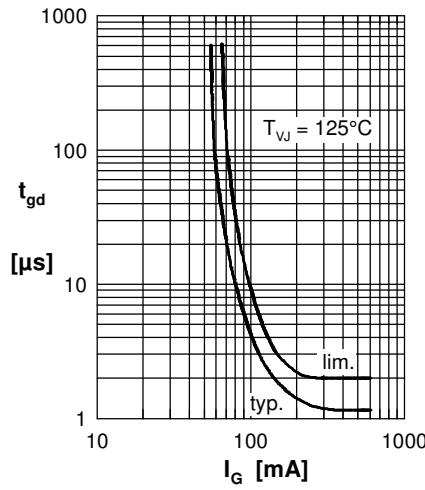

Fig. 5 Gate controlled delay time  $t_{gd}$

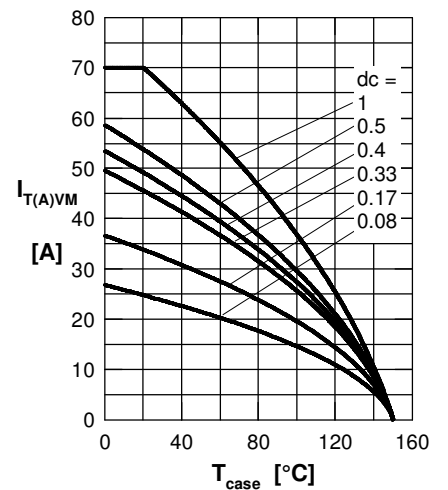

Fig. 6 Max. forward current at case temperature

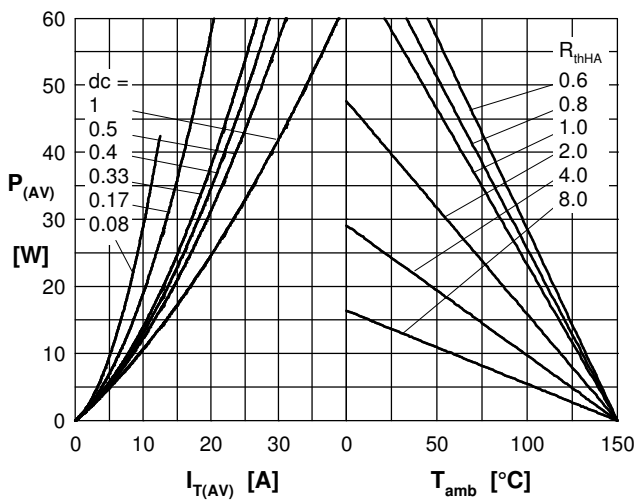

Fig. 7a Power dissipation versus direct output current  
Fig. 7b and ambient temperature

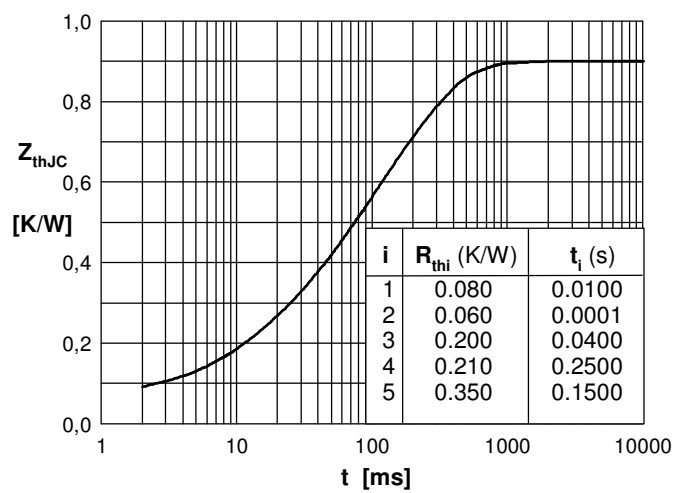

Fig. 7 Transient thermal impedance junction to case

# Mouser Electronics

Authorized Distributor

Click to View Pricing, Inventory, Delivery & Lifecycle Information:

[IXYS:](#)

[CMA60MT1600NHR](#)