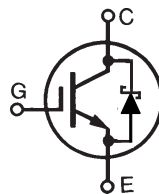


# GenX3™ 600V IGBT w/ SiC Anti-Parallel Diode

## IXGH48N60C3C1

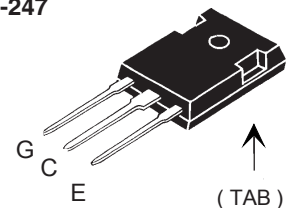


$$\begin{aligned}
 V_{CES} &= 600V \\
 I_{C110} &= 48A \\
 V_{CE(sat)} &\leq 2.5V \\
 t_{fi(typ)} &= 38ns
 \end{aligned}$$

High Speed PT IGBT for  
40 - 100kHz Switching

Symbol	Test Conditions	Maximum Ratings	
$V_{CES}$	$T_J = 25^\circ\text{C}$ to $150^\circ\text{C}$	600	V
$V_{CGR}$	$T_J = 25^\circ\text{C}$ to $150^\circ\text{C}$ , $R_{GE} = 1M\Omega$	600	V
$V_{GES}$	Continuous	$\pm 20$	V
$V_{GEM}$	Transient	$\pm 30$	V
$I_{C25}$	$T_C = 25^\circ\text{C}$ (Limited by Leads)	75	A
$I_{C110}$	$T_C = 110^\circ\text{C}$	48	A
$I_{F110}$	$T_C = 110^\circ\text{C}$	20	A
$I_{CM}$	$T_C = 25^\circ\text{C}$ , 1ms	250	A
$I_A$	$T_C = 25^\circ\text{C}$	30	A
$E_{AS}$	$T_C = 25^\circ\text{C}$	300	mJ
<b>SSOA</b>	$V_{GE} = 15V$ , $T_{VJ} = 125^\circ\text{C}$ , $R_G = 3\Omega$	$I_{CM} = 100$	A
<b>(RBSOA)</b>	Clamped Inductive Load	@ $\leq V_{CES}$	
$P_C$	$T_C = 25^\circ\text{C}$	300	W
$T_J$		-55 ... +150	$^\circ\text{C}$
$T_{JM}$		150	$^\circ\text{C}$
$T_{stg}$		-55 ... +150	$^\circ\text{C}$
$T_L$	1.6mm (0.062 in.) from Case for 10s	300	$^\circ\text{C}$
$T_{SOLD}$	Plastic Body for 10 Seconds	260	$^\circ\text{C}$
$F_C$	Mounting Torque	1.13/10	Nm/lb.in
<b>Weight</b>		6	g

TO-247



G = Gate      C = Collector  
E = Emitter    TAB = Collector

### Features

- Optimized for Low Switching Losses
- Square RBSOA
- Anti-Parallel Schottky Diode
- Fast Switching
- Avalanche Rated
- International Standard Package

### Advantages

- High Power Density
- Low Gate Drive Requirement

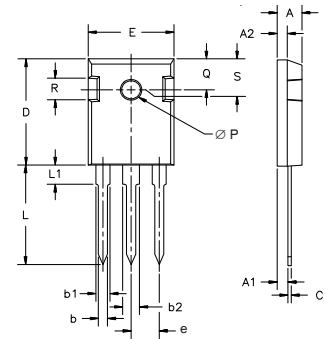
### Applications

- High Frequency Power Inverters
- UPS
- Motor Drives
- SMPS
- PFC Circuits
- Battery Chargers
- Welding Machines
- Lamp Ballasts

Symbol	Test Conditions ( $T_J = 25^\circ\text{C}$ , Unless Otherwise Specified)	Characteristic Values		
		Min.	Typ.	Max.
$V_{GE(th)}$	$I_C = 250\mu\text{A}$ , $V_{CE} = V_{GE}$	3.0		5.5 V
$I_{CES}$	$V_{CE} = V_{CES}$ , $V_{GE} = 0V$ $T_J = 125^\circ\text{C}$			50 $\mu\text{A}$ 1.75 mA
$I_{GES}$	$V_{CE} = 0V$ , $V_{GE} = \pm 20V$			$\pm 100$ nA
$V_{CE(sat)}$	$I_C = 30A$ , $V_{GE} = 15V$ , Note 1 $T_J = 125^\circ\text{C}$		2.3 1.8	2.5 V V

Symbol	Test Conditions ( $T_J = 25^\circ\text{C}$ , Unless Otherwise Specified)	Characteristic Values			
		Min.	Typ.	Max.	
$g_{fs}$	$I_C = 30\text{A}$ , $V_{CE} = 10\text{V}$ , Note 1	20	30	S	
$C_{ies}$	$V_{CE} = 25\text{V}$ , $V_{GE} = 0\text{V}$ , $f = 1\text{MHz}$		2120	pF	
$C_{oes}$			420	pF	
$C_{res}$			50	pF	
$Q_g$	$I_C = 30\text{A}$ , $V_{GE} = 15\text{V}$ , $V_{CE} = 0.5 \cdot V_{CES}$		77	nC	
$Q_{ge}$			16	nC	
$Q_{gc}$			32	nC	
$t_{d(on)}$	<b>Inductive Load, <math>T_J = 25^\circ\text{C}</math></b> $I_C = 30\text{A}$ , $V_{GE} = 15\text{V}$ $V_{CE} = 400\text{V}$ , $R_G = 3\Omega$ Note 2		19	ns	
$t_{ri}$			25	ns	
$E_{on}$			0.33	mJ	
$t_{d(off)}$			60	100	ns
$t_{fi}$			38	ns	
$E_{off}$			0.23	0.42	mJ
$t_{d(on)}$	<b>Inductive Load, <math>T_J = 125^\circ\text{C}</math></b> $I_C = 30\text{A}$ , $V_{GE} = 15\text{V}$ $V_{CE} = 400\text{V}$ , $R_G = 3\Omega$ Note 2		19	ns	
$t_{ri}$			28	ns	
$E_{on}$			0.37	mJ	
$t_{d(off)}$			92	ns	
$t_{fi}$			95	ns	
$E_{off}$			0.57	mJ	
$R_{thJC}$			0.42	$^\circ\text{C/W}$	
$R_{thCS}$		0.21		$^\circ\text{C/W}$	

TO-247 AD Outline



Dim.	Millimeter		Inches	
	Min.	Max.	Min.	Max.
A	4.7	5.3	.185	.209
A <sub>1</sub>	2.2	2.54	.087	.102
A <sub>2</sub>	2.2	2.6	.059	.098
b	1.0	1.4	.040	.055
b <sub>1</sub>	1.65	2.13	.065	.084
b <sub>2</sub>	2.87	3.12	.113	.123
C	.4	.8	.016	.031
D	20.80	21.46	.819	.845
E	15.75	16.26	.610	.640
e	5.20	5.72	0.205	0.225
L	19.81	20.32	.780	.800
L1		4.50		.177
∅P	3.55	3.65	.140	.144
Q	5.89	6.40	0.232	0.252
R	4.32	5.49	.170	.216

### Reverse Diode (SiC)

Symbol	Test Conditions ( $T_J = 25^\circ\text{C}$ , Unless Otherwise Specified)	Characteristic Values		
		Min.	Typ.	Max.
$V_F$	$I_F = 20\text{A}$ , $V_{GE} = 0\text{V}$ , Note 1 $T_J = 125^\circ\text{C}$		1.65 1.80	V V
$R_{thJC}$				0.90 $^\circ\text{C/W}$

### Notes

1. Pulse test,  $t \leq 300\mu\text{s}$ , duty cycle,  $d \leq 2\%$ .
2. Switching times & energy losses may increase for higher  $V_{CE}$  (Clamp),  $T_J$  or  $R_G$ .

### PRELIMINARY TECHNICAL INFORMATION

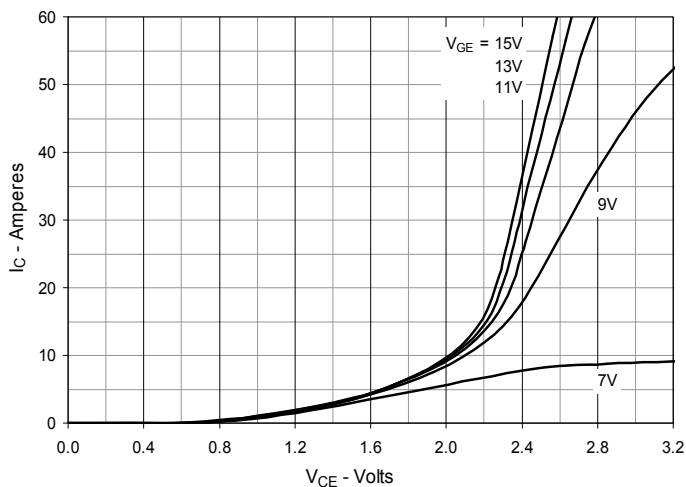
The product presented herein is under development. The Technical Specifications offered are derived from data gathered during objective characterizations of preliminary engineering lots; but also may yet contain some information supplied during a pre-production design evaluation. IXYS reserves the right to change limits, test conditions, and dimensions without notice.

IXYS Reserves the Right to Change Limits, Test Conditions, and Dimensions.

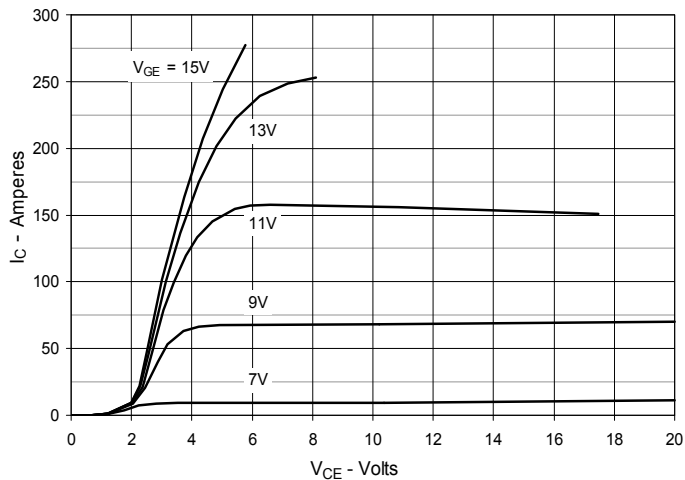
IXYS MOSFETs and IGBTs are covered by one or more of the following U.S. patents:

4,835,592	4,931,844	5,049,961	5,237,481	6,162,665	6,404,065 B1	6,683,344	6,727,585	7,005,734 B2	7,157,338 B2
4,850,072	5,017,508	5,063,307	5,381,025	6,259,123 B1	6,534,343	6,710,405 B2	6,759,692	7,063,975 B2	
4,881,106	5,034,796	5,187,117	5,486,715	6,306,728 B1	6,583,505	6,710,463	6,771,478 B2	7,071,537	

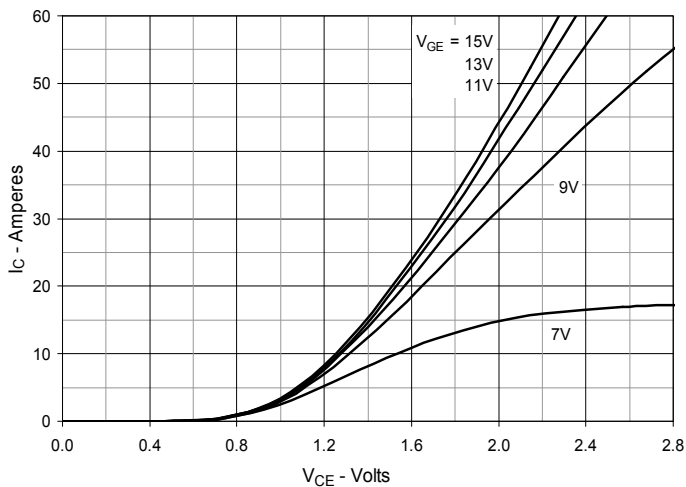
**Fig. 1. Output Characteristics @ 25°C**



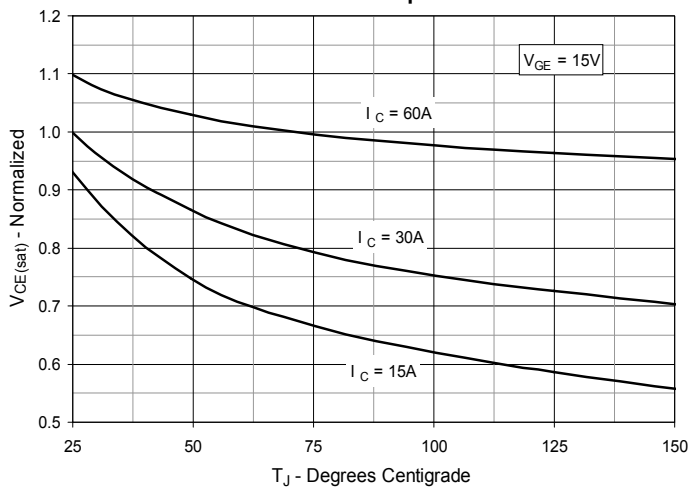
**Fig. 2. Extended Output Characteristics @ 25°C**



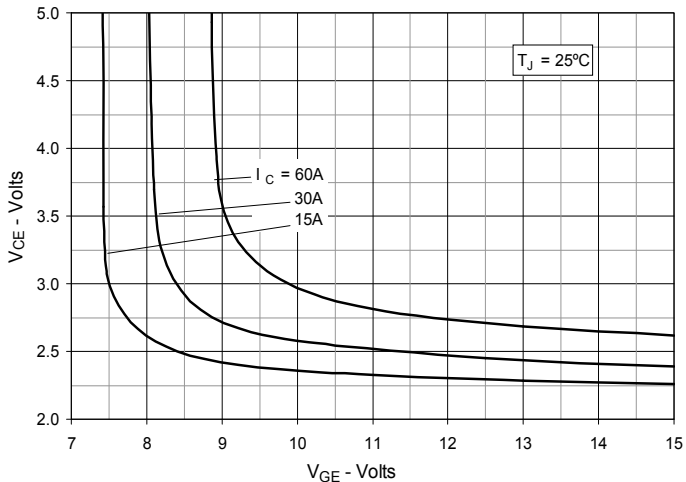
**Fig. 3. Output Characteristics @ 125°C**



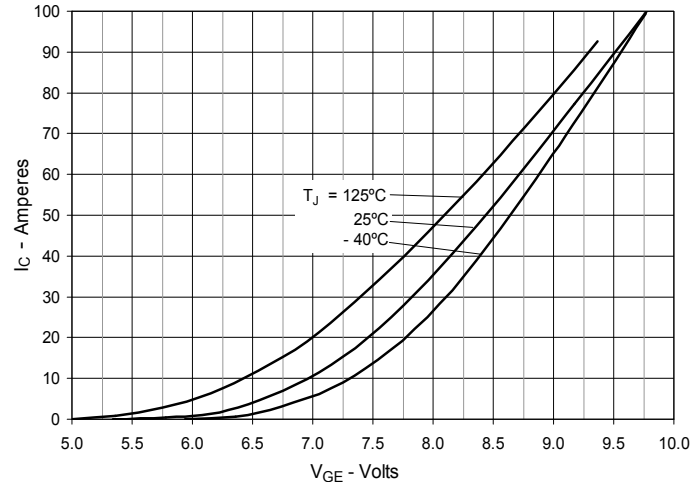
**Fig. 4. Dependence of  $V_{CE(sat)}$  on Junction Temperature**



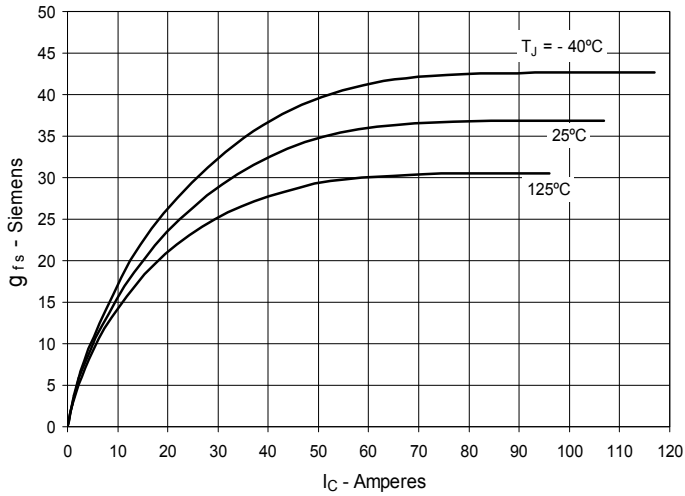
**Fig. 5. Collector-to-Emitter Voltage vs. Gate-to-Emitter Voltage**



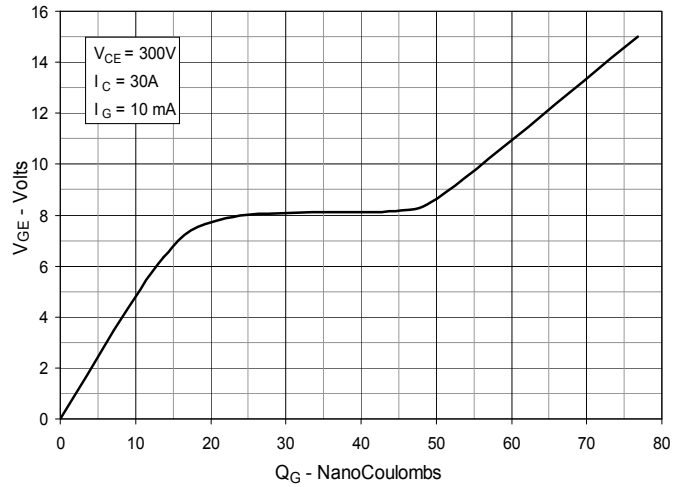
**Fig. 6. Input Admittance**



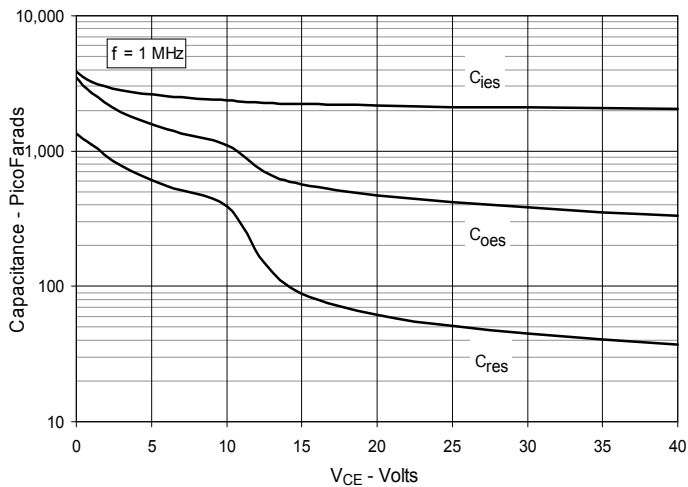
**Fig. 7. Transconductance**



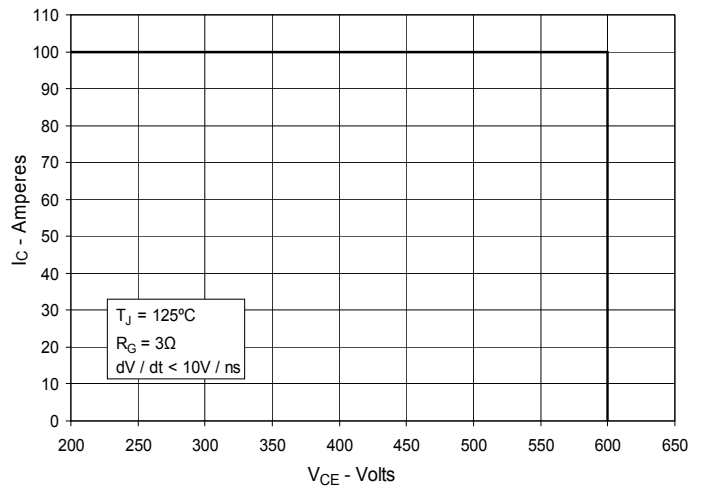
**Fig. 8. Gate Charge**



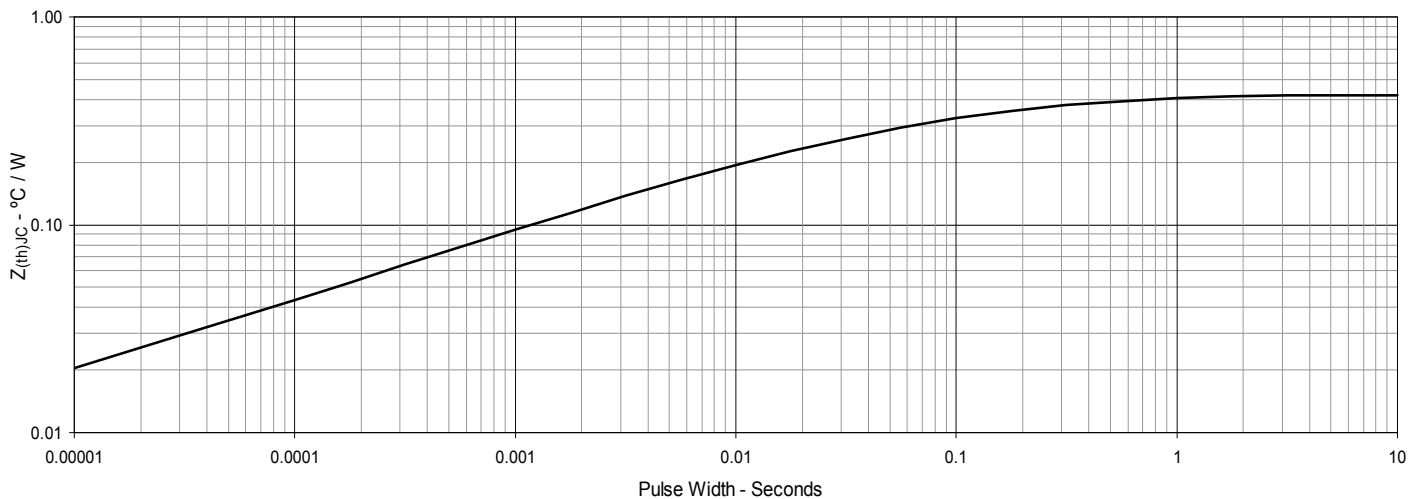
**Fig. 9. Capacitance**

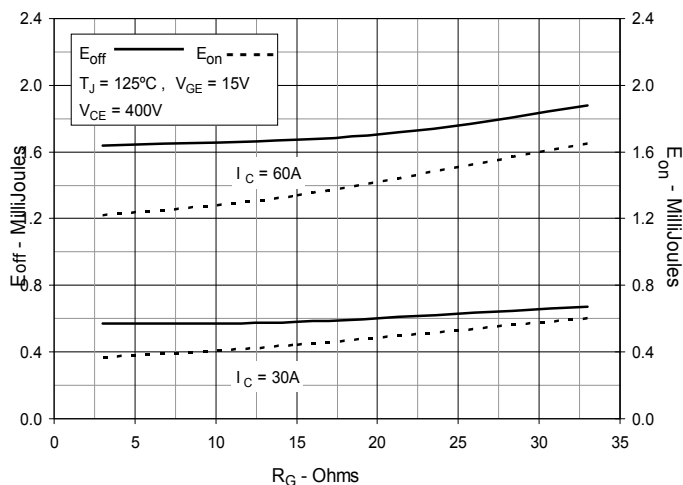
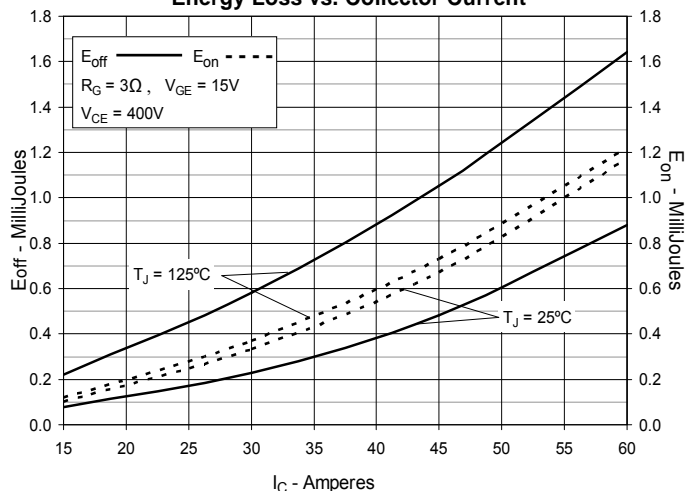
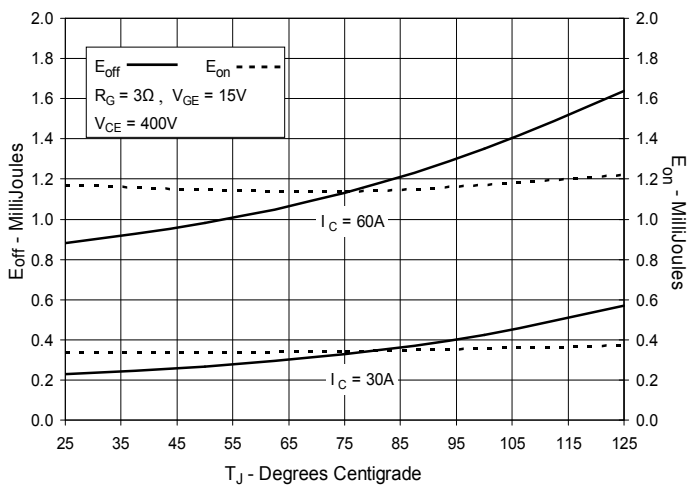
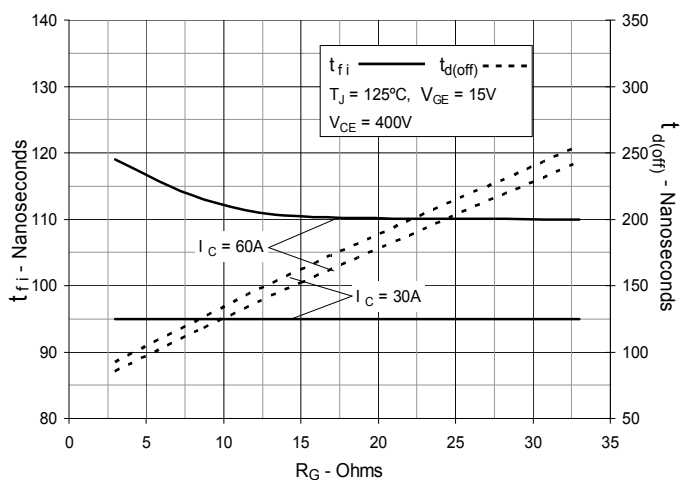
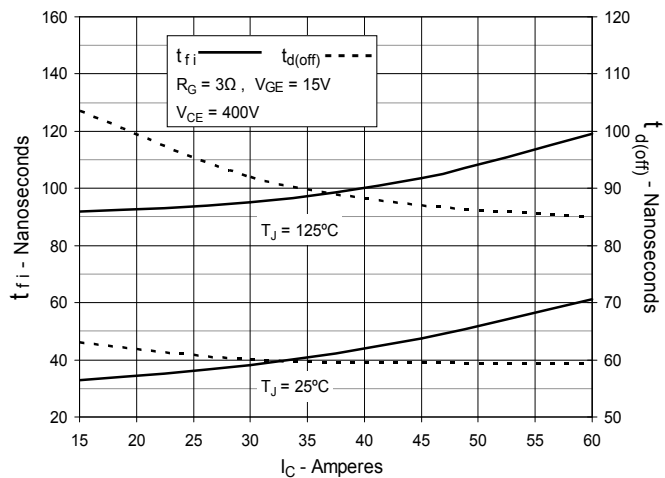
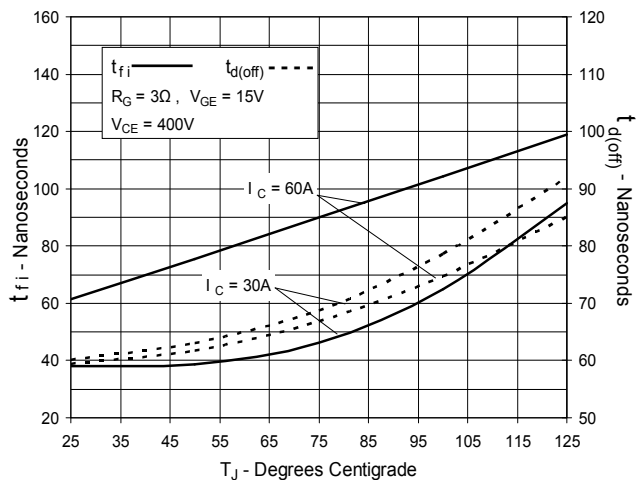


**Fig. 10. Reverse-Bias Safe Operating Area**

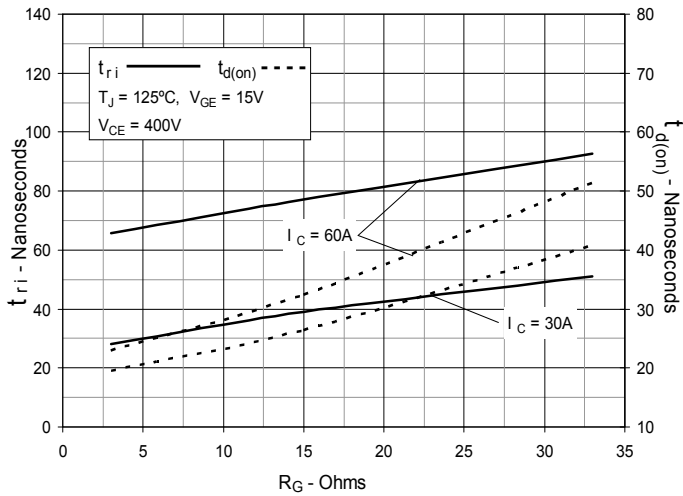


**Fig. 11. Maximum Transient Thermal Impedance**

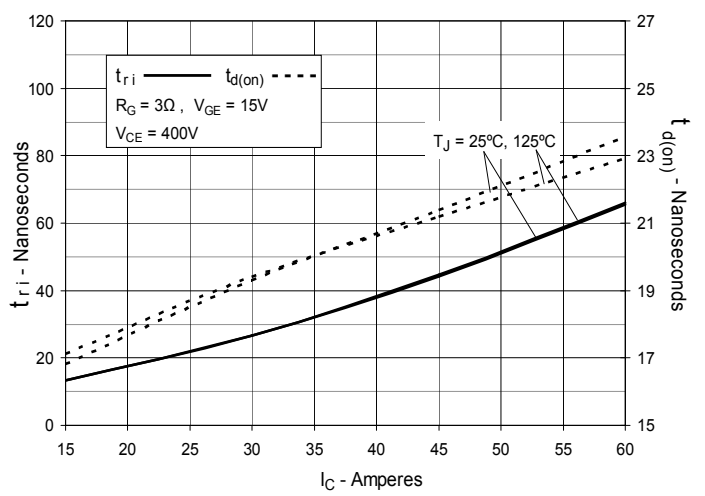


**Fig. 12. Inductive Switching  
Energy Loss vs. Gate Resistance**

**Fig. 13. Inductive Switching  
Energy Loss vs. Collector Current**

**Fig. 14. Inductive Switching  
Energy Loss vs. Junction Temperature**

**Fig. 15. Inductive Turn-off  
Switching Times vs. Gate Resistance**

**Fig. 16. Inductive Turn-off  
Switching Times vs. Collector Current**

**Fig. 17. Inductive Turn-off  
Switching Times vs. Junction Temperature**


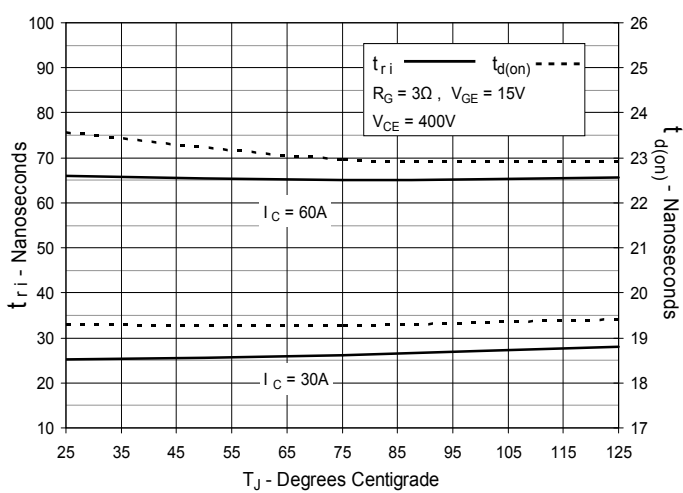
**Fig. 18. Inductive Turn-on  
Switching Times vs. Gate Resistance**



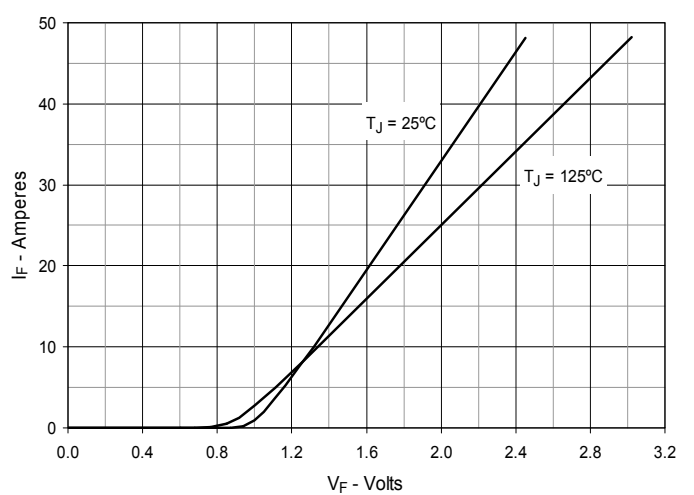
**Fig. 19. Inductive Turn-on  
Switching Times vs. Collector Current**



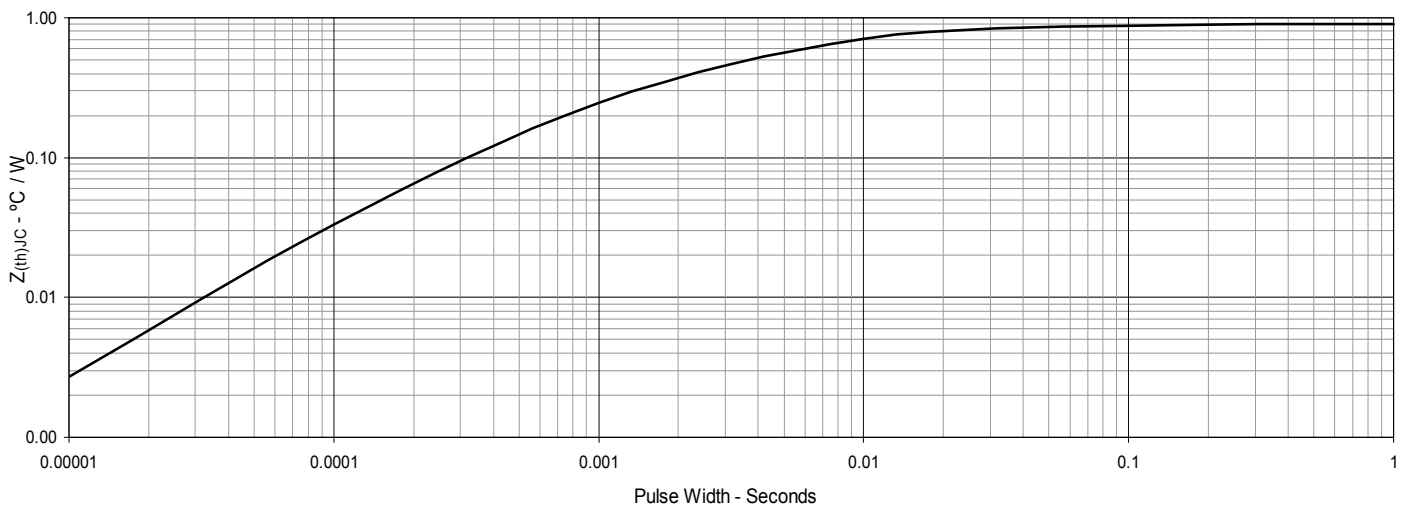
**Fig. 20. Inductive Turn-on  
Switching Times vs. Junction Temperature**



**Fig. 21. Forward Current vs. Forward Voltage**



**Fig. 22. Maximum Transient Thermal Impedance for Diode**



# Mouser Electronics

Authorized Distributor

Click to View Pricing, Inventory, Delivery & Lifecycle Information:

[IXYS:](#)

[IXGH48N60C3C1](#)