

**XPT™ 600V IGBTs**  
**GenX3™**
**IXXK300N60C3**  
**IXXX300N60C3**

$$V_{CES} = 600V$$

$$I_{C110} = 300A$$

$$V_{CE(sat)} \leq 2.0V$$

$$t_{fi(typ)} = 82ns$$

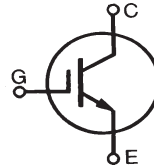
 Extreme Light Punch Through  
 IGBT for 20-60kHz Switching

| Symbol                        | Test Conditions   | Maximum Ratings                           |            |
|-------------------------------|---|---|------------|
| $V_{CES}$                     | $T_J = 25^\circ C$ to $175^\circ C$   | 600                                       | V          |
| $V_{CGR}$                     | $T_J = 25^\circ C$ to $175^\circ C$ , $R_{GE} = 1M\Omega$                                   | 600                                       | V          |
| $V_{GES}$                     | Continuous  | $\pm 20$                                  | V          |
| $V_{GEM}$                     | Transient   | $\pm 30$                                  | V          |
| $I_{C25}$                     | $T_C = 25^\circ C$ (Chip Capability)  | 510                                       | A          |
| $I_{LRMS}$                    | Terminal Current Limit  | 160                                       | A          |
| $I_{C110}$                    | $T_C = 110^\circ C$ (Chip Capability)   | 300                                       | A          |
| $I_{CM}$                      | $T_C = 25^\circ C$ , 1ms  | 1075                                      | A          |
| $I_A$                         | $T_C = 25^\circ C$  | 100                                       | A          |
| $E_{AS}$                      | $T_C = 25^\circ C$  | 500                                       | mJ         |
| <b>SSOA</b><br><b>(RBSOA)</b> | $V_{GE} = 15V$ , $T_{VJ} = 150^\circ C$ , $R_G = 1\Omega$<br>Clamped Inductive Load         | $I_{CM} = 600$<br>@ $V_{CE} \leq V_{CES}$ | A          |
| $t_{sc}$<br><b>(SCSOA)</b>    | $V_{GE} = 15V$ , $V_{CE} = 360V$ , $T_J = 150^\circ C$<br>$R_G = 10\Omega$ , Non Repetitive | 10  | $\mu s$    |
| $P_C$                         | $T_C = 25^\circ C$  | 2300                                      | W          |
| $T_J$                         |   | -55 ... +175                              | $^\circ C$ |
| $T_{JM}$                      |   | 175                                       | $^\circ C$ |
| $T_{stg}$                     |   | -55 ... +175                              | $^\circ C$ |
| $T_L$                         | Maximum Lead Temperature for Soldering  | 300                                       | $^\circ C$ |
| $T_{SOLD}$                    | 1.6 mm (0.062in.) from Case for 10s   | 260                                       | $^\circ C$ |
| $M_d$                         | Mounting Torque (TO-264)  | 1.13/10                                   | Nm/lb.in.  |
| $F_C$                         | Mounting Force (PLUS247)  | 20..120 /4.5..27                          | N/lb.      |
| <b>Weight</b>                 | TO-264  | 10  | g          |
|                               | PLUS247   | 6   | g          |

TO-264 (IXXK)

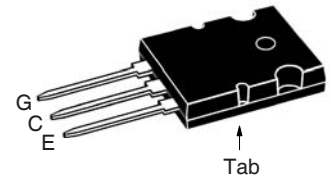

PLUS247 (IXXX)

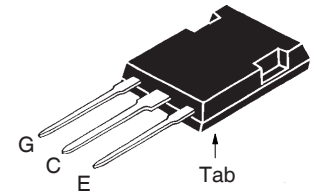
 G = Gate  
 C = Collector

 E = Emitter  
 Tab = Collector

**Features**

- Optimized for 20-60kHz Switching
- Square RBSOA
- International Standard Packages
- Avalanche Rated
- Short Circuit Capability
- High Current Handling Capability

**Advantages**

- High Power Density
- Low Gate Drive Requirement

**Applications**

- Power Inverters
- UPS
- Motor Drives
- SMPS
- PFC Circuits
- Battery Chargers
- Welding Machines
- Lamp Ballasts

| Symbol        | Test Conditions<br>( $T_J = 25^\circ C$ , Unless Otherwise Specified) | Characteristic Values |            |                    |
|---------------|---|-----------------------|------------|--------------------|
|               |   | Min.                  | Typ.       | Max.               |
| $BV_{CES}$    | $I_C = 250\mu A$ , $V_{GE} = 0V$                                      | 600                   |            | V                  |
| $V_{GE(th)}$  | $I_C = 250\mu A$ , $V_{CE} = V_{GE}$                                  | 3.0                   |            | 5.5 V              |
| $I_{CES}$     | $V_{CE} = V_{CES}$ , $V_{GE} = 0V$<br>$T_J = 150^\circ C$             |                       |            | 25 $\mu A$<br>2 mA |
| $I_{GES}$     | $V_{CE} = 0V$ , $V_{GE} = \pm 20V$                                    |                       |            | $\pm 200$ nA       |
| $V_{CE(sat)}$ | $I_C = 100A$ , $V_{GE} = 15V$ , Note 1<br>$T_J = 150^\circ C$         |                       | 1.5<br>1.7 | V<br>V             |

**Symbol Test Conditions**

( $T_J = 25^\circ\text{C}$  Unless Otherwise Specified)

**Characteristic Values**

|              |  | Min. | Typ. | Max.  |                    |
|--------------|--|------|------|-------|--------------------|
| $g_{fs}$     | $I_C = 60\text{A}, V_{CE} = 10\text{V}$ , Note 1   | 30   | 52   |       | S                  |
| $C_{ies}$    | $V_{CE} = 25\text{V}, V_{GE} = 0\text{V}, f = 1\text{MHz}$   |      | 13.5 |       | nF                 |
| $C_{oes}$    |  |      | 743  |       | pF                 |
| $C_{res}$    |  |      | 237  |       | pF                 |
| $Q_g$        | $I_C = 300\text{A}, V_{GE} = 15\text{V}, V_{CE} = 0.5 \cdot V_{CES}$   |      | 438  |       | nC                 |
| $Q_{ge}$     |  |      | 124  |       | nC                 |
| $Q_{gc}$     |  |      | 208  |       | nC                 |
| $t_{d(on)}$  | <b>Inductive load, <math>T_J = 25^\circ\text{C}</math></b><br>$I_C = 100\text{A}, V_{GE} = 15\text{V}$<br>$V_{CE} = 400\text{V}, R_G = 1\Omega$<br>Note 2  |      | 50   |       | ns                 |
| $t_{ri}$     |  |      | 85   |       | ns                 |
| $E_{on}$     |  |      | 3.35 |       | mJ                 |
| $t_{d(off)}$ |  |      | 160  |       | ns                 |
| $t_{fi}$     |  |      | 82   |       | ns                 |
| $E_{off}$    |  | 1.90 | 2.80 |       | mJ                 |
| $t_{d(on)}$  | <b>Inductive load, <math>T_J = 150^\circ\text{C}</math></b><br>$I_C = 100\text{A}, V_{GE} = 15\text{V}$<br>$V_{CE} = 400\text{V}, R_G = 1\Omega$<br>Note 2 |      | 48   |       | ns                 |
| $t_{ri}$     |  |      | 80   |       | ns                 |
| $E_{on}$     |  |      | 4.25 |       | mJ                 |
| $t_{d(off)}$ |  |      | 188  |       | ns                 |
| $t_{fi}$     |  |      | 90   |       | ns                 |
| $E_{off}$    |  | 2.35 |      | mJ    |                    |
| $R_{thJC}$   |  |      |      | 0.065 | $^\circ\text{C/W}$ |
| $R_{thCS}$   |  | 0.15 |      |       | $^\circ\text{C/W}$ |

**Notes:**

1. Pulse test,  $t \leq 300\mu\text{s}$ , duty cycle,  $d \leq 2\%$ .
2. Switching times & energy losses may increase for higher  $V_{CE}$  (clamp),  $T_J$  or  $R_G$ .

**ADVANCE TECHNICAL INFORMATION**

The product presented herein is under development. The Technical Specifications offered are derived from a subjective evaluation of the design, based upon prior knowledge and experience, and constitute a "considered reflection" of the anticipated result. IXYS reserves the right to change limits, test conditions, and dimensions without notice.

**TO-264 Outline**

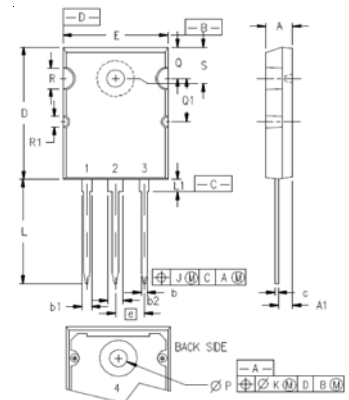

Terminals: 1 = Gate  
2,4 = Collector  
3 = Emitter

| SYM | INCHES   |       | MILLIMETERS |       |
|-----|----------|-------|-------------|-------|
|     | MIN      | MAX   | MIN         | MAX   |
| A   | .185     | .209  | 4.70        | 5.31  |
| A1  | .102     | .118  | 2.59        | 3.00  |
| b   | .037     | .055  | 0.94        | 1.40  |
| b1  | .087     | .102  | 2.21        | 2.59  |
| b2  | .110     | .126  | 2.79        | 3.20  |
| c   | .017     | .029  | 0.43        | 0.74  |
| D   | 1.007    | 1.047 | 25.58       | 26.59 |
| E   | .760     | .799  | 19.30       | 20.29 |
| e   | .215 BSC |       | 5.46 BSC    |       |
| J   | .000     | .010  | 0.00        | 0.25  |
| K   | .000     | .010  | 0.00        | 0.25  |
| L   | .779     | .842  | 19.79       | 21.39 |
| L1  | .087     | .102  | 2.21        | 2.59  |
| ØP  | .122     | .138  | 3.10        | 3.51  |
| Q   | .240     | .256  | 6.10        | 6.50  |
| Q1  | .330     | .346  | 8.38        | 8.79  |
| ØR  | .155     | .187  | 3.94        | 4.75  |
| ØR1 | .085     | .093  | 2.16        | 2.36  |
| S   | .243     | .253  | 6.17        | 6.43  |

**PLUS247™ Outline**

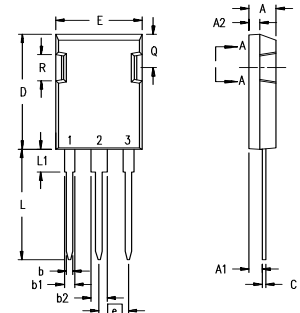

Terminals: 1 - Gate  
2 - Collector  
3 - Emitter

| Dim.           | Millimeter |       | Inches   |       |
|----------------|------------|-------|----------|-------|
|                | Min.       | Max.  | Min.     | Max.  |
| A              | 4.83       | 5.21  | .190     | .205  |
| A <sub>1</sub> | 2.29       | 2.54  | .090     | .100  |
| A <sub>2</sub> | 1.91       | 2.16  | .075     | .085  |
| b              | 1.14       | 1.40  | .045     | .055  |
| b <sub>1</sub> | 1.91       | 2.13  | .075     | .084  |
| b <sub>2</sub> | 2.92       | 3.12  | .115     | .123  |
| C              | 0.61       | 0.80  | .024     | .031  |
| D              | 20.80      | 21.34 | .819     | .840  |
| E              | 15.75      | 16.13 | .620     | .635  |
| e              | 5.45 BSC   |       | .215 BSC |       |
| L              | 19.81      | 20.32 | .780     | .800  |
| L1             | 3.81       | 4.32  | .150     | .170  |
| Q              | 5.59       | 6.20  | .220     | 0.244 |
| R              | 4.32       | 4.83  | .170     | .190  |

IXYS Reserves the Right to Change Limits, Test Conditions, and Dimensions.

|  |           |           |           |           |              |              |              |              |              |             |
|--|-----------|-----------|-----------|-----------|--------------|--------------|--------------|--------------|--------------|-------------|
| IXYS MOSFETs and IGBTs are covered by one or more of the following U.S. patents: | 4,835,592 | 4,931,844 | 5,049,961 | 5,237,481 | 6,162,665    | 6,404,065 B1 | 6,683,344    | 6,727,585    | 7,005,734 B2 | 7,157,338B2 |
|  | 4,860,072 | 5,017,508 | 5,063,307 | 5,381,025 | 6,259,123 B1 | 6,534,343    | 6,710,405 B2 | 6,759,692    | 7,063,975 B2 |             |
|  | 4,881,106 | 5,034,796 | 5,187,117 | 5,486,715 | 6,306,728 B1 | 6,583,505    | 6,710,463    | 6,771,478 B2 | 7,071,537    |             |

**Fig. 1. Output Characteristics @  $T_J = 25^\circ\text{C}$**

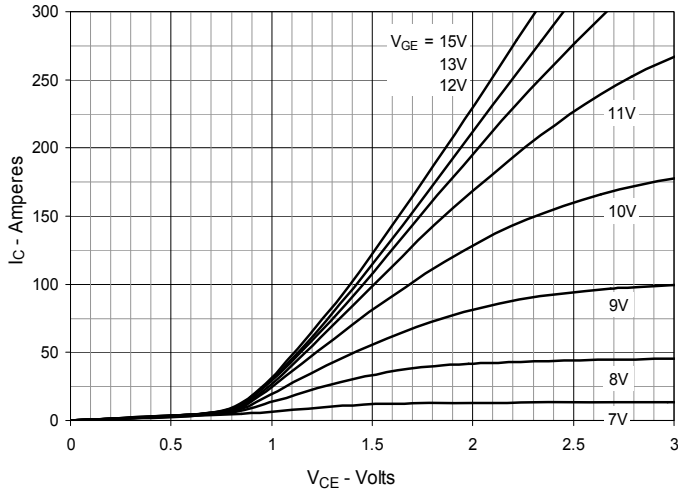

**Fig. 2. Extended Output Characteristics @  $T_J = 25^\circ\text{C}$**

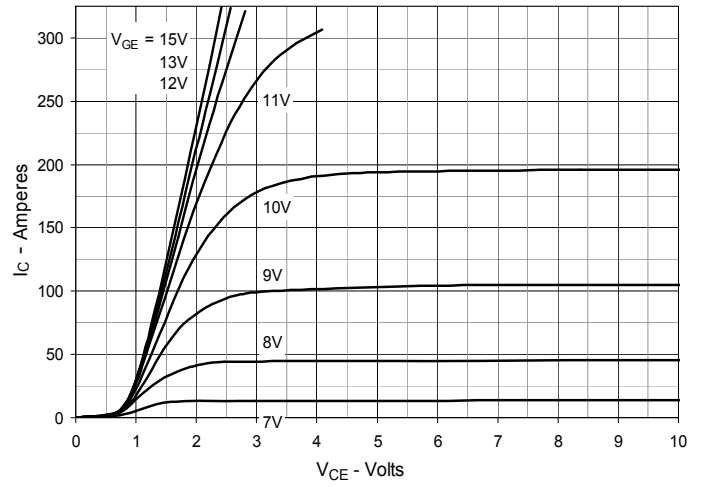

**Fig. 3. Output Characteristics @  $T_J = 150^\circ\text{C}$**

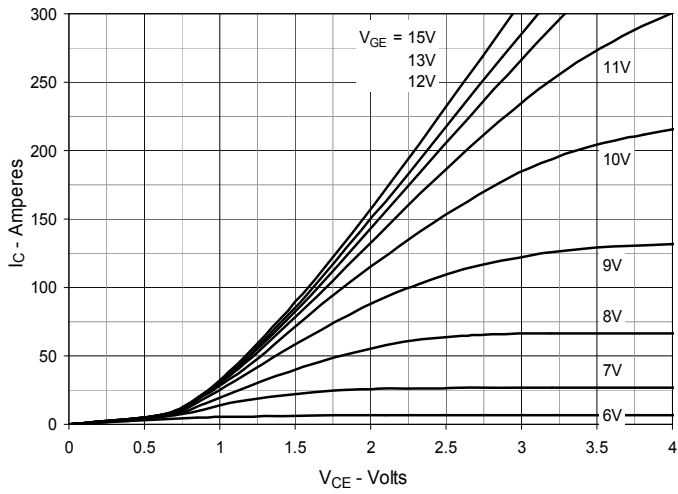

**Fig. 4. Dependence of  $V_{CE(sat)}$  on Junction Temperature**

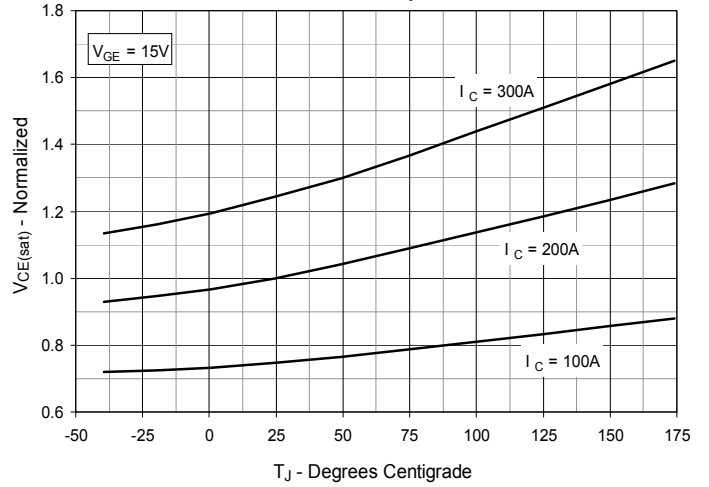

**Fig. 5. Collector-to-Emitter Voltage vs. Gate-to-Emitter Voltage**

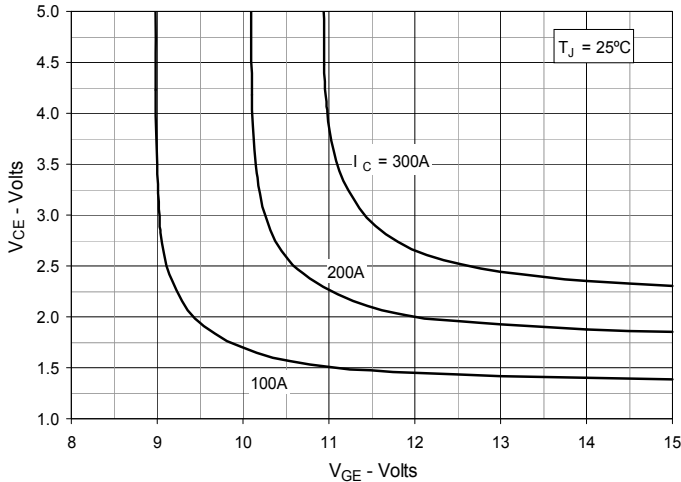

**Fig. 6. Input Admittance**

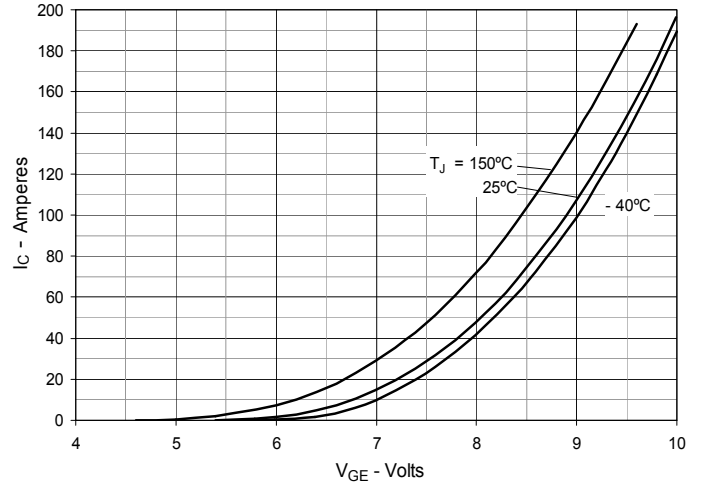

**Fig. 7. Transconductance**

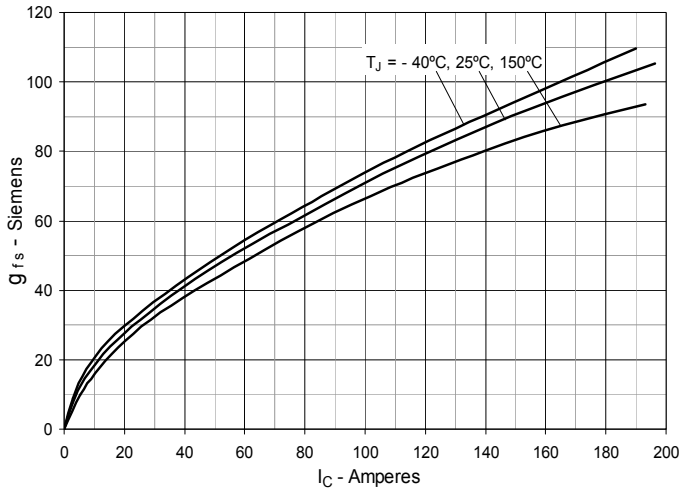

**Fig. 8. Gate Charge**

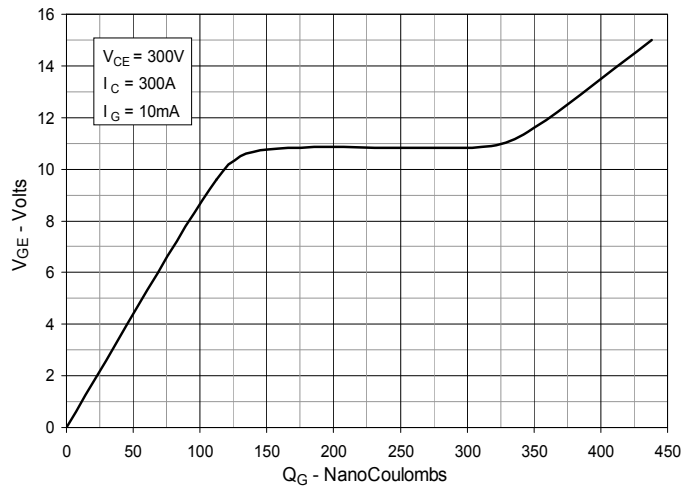

**Fig. 9. Capacitance**

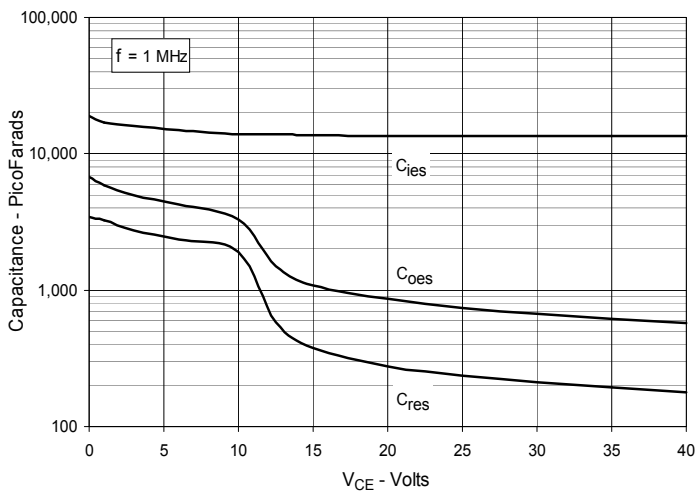

**Fig. 10. Reverse-Bias Safe Operating Area**

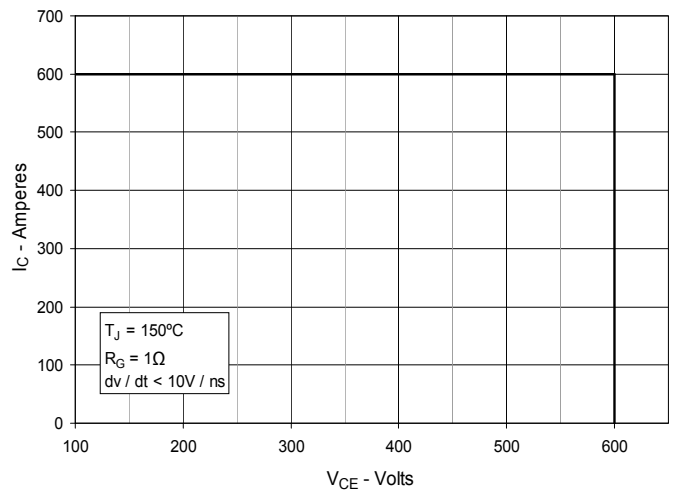

**Fig. 11. Maximum Transient Thermal Impedance**

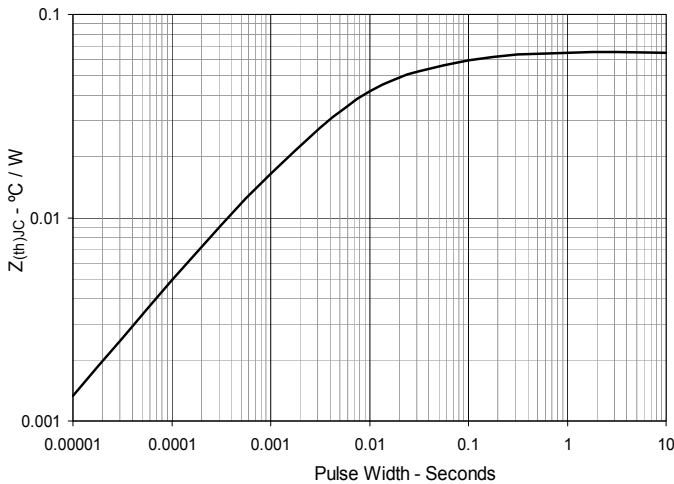

**Fig. 12. Forward-Bias Safe Operating Area**

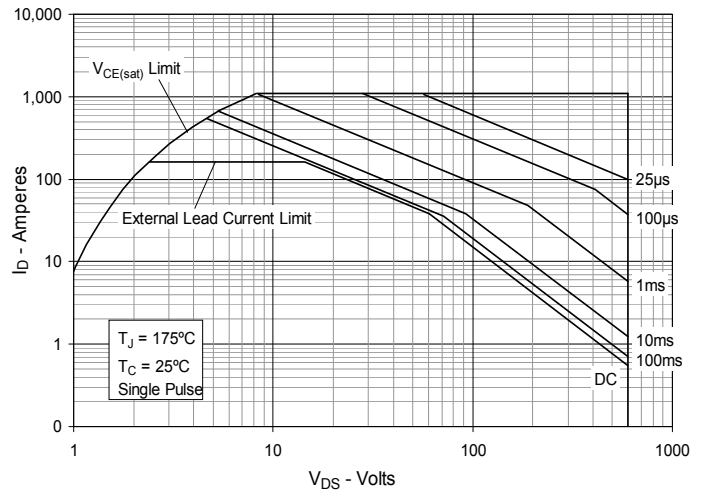

**Fig. 13. Inductive Switching Energy Loss vs. Gate Resistance**

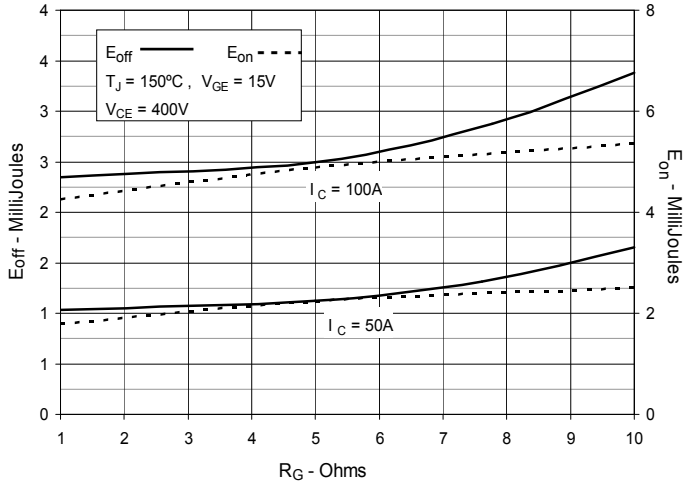

**Fig. 14. Inductive Switching Energy Loss vs. Collector Current**

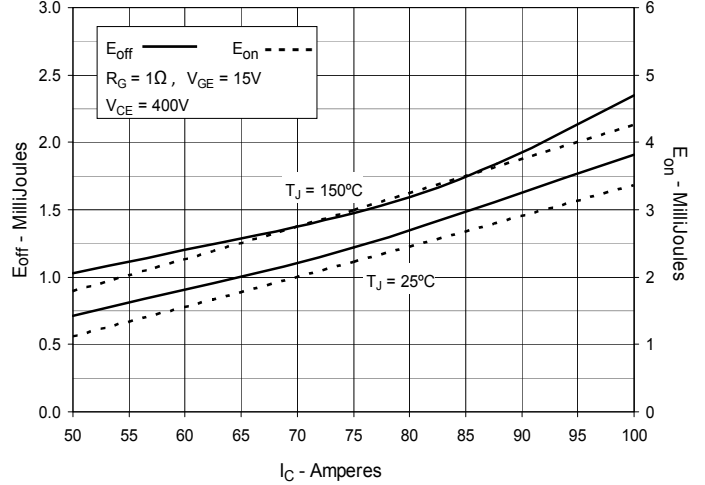

**Fig. 15. Inductive Switching Energy Loss vs. Junction Temperature**

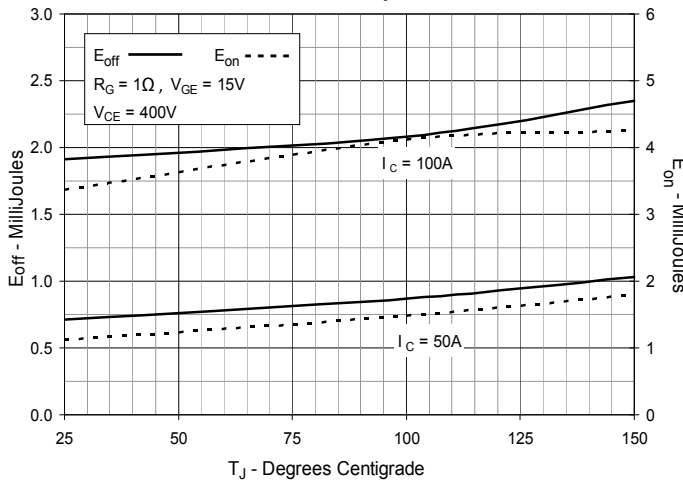

**Fig. 16. Inductive Turn-off Switching Times vs. Gate Resistance**

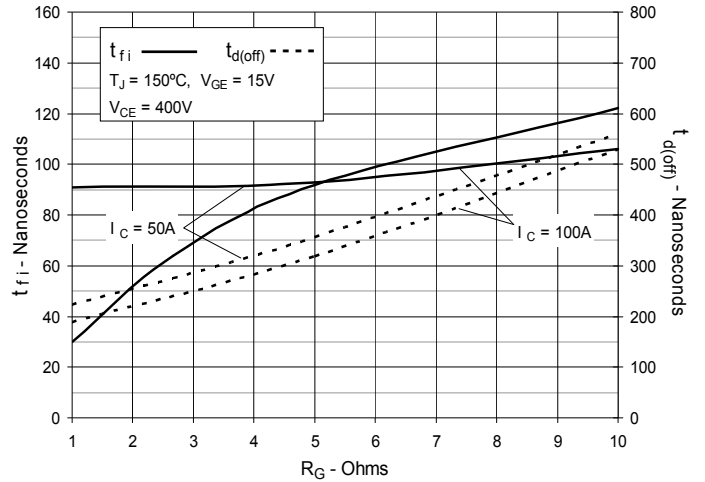

**Fig. 17. Inductive Turn-off Switching Times vs. Collector Current**

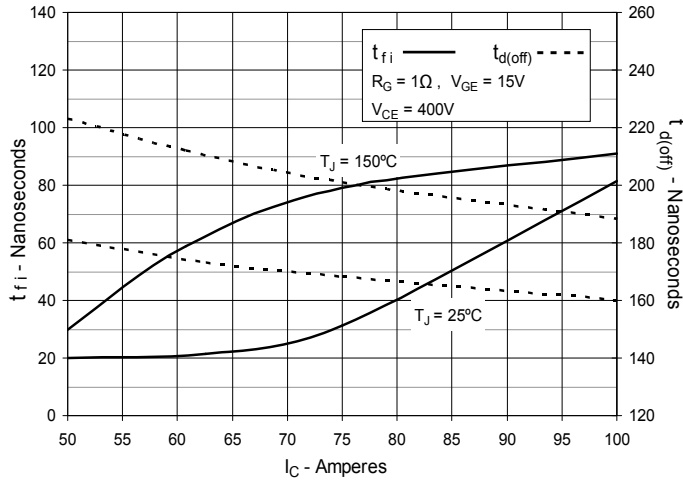

**Fig. 18. Inductive Turn-off Switching Times vs. Junction Temperature**

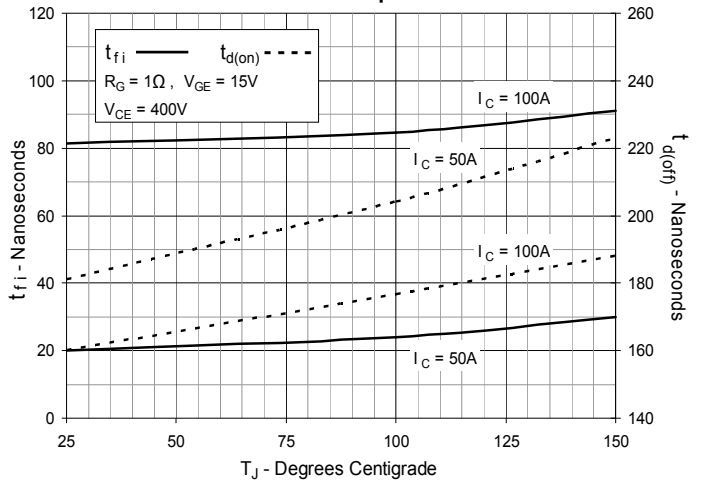

**Fig. 19. Inductive Turn-on Switching Times vs. Gate Resistance**

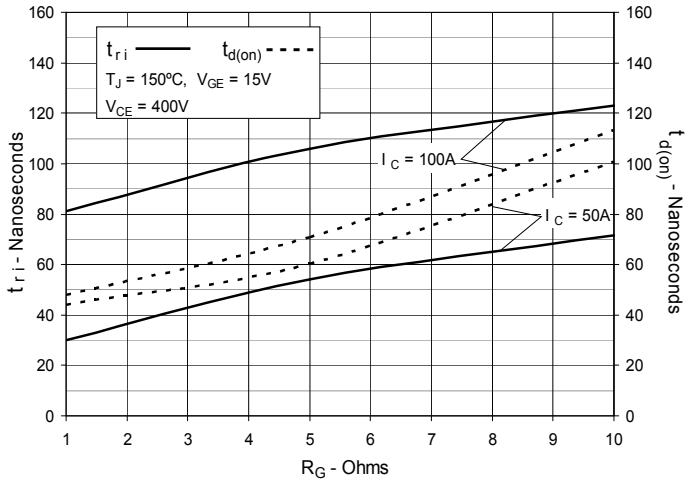

**Fig. 20. Inductive Turn-on Switching Times vs. Collector Current**

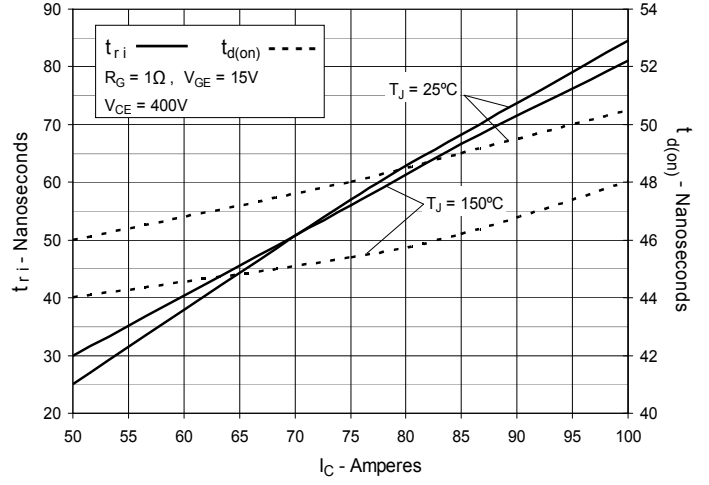

**Fig. 21. Inductive Turn-on Switching Times vs. Junction Temperature**

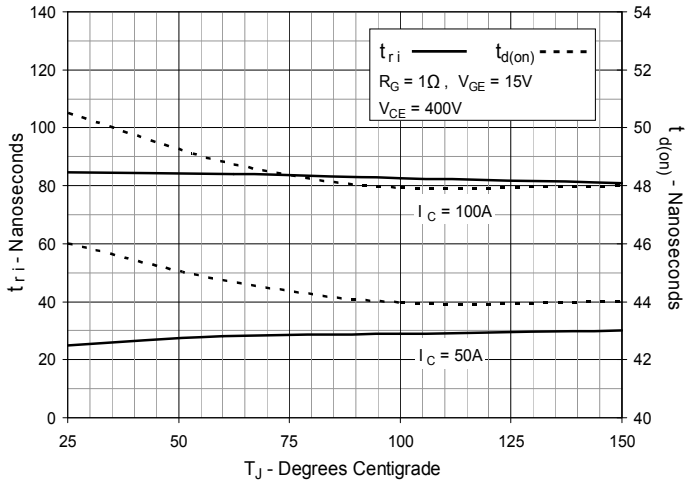

# Mouser Electronics

Authorized Distributor

Click to View Pricing, Inventory, Delivery & Lifecycle Information:

[IXYS:](#)

[IXXK300N60C3](#) [IXXX300N60C3](#)