

# Three phase full Bridge

with Trench MOSFETs  
in DCB isolated high current package

$V_{DSS} = 150\text{ V}$   
 $I_{D25} = 50\text{ A}$   
 $R_{DSon\ typ.} = 19\text{ m}\Omega$

Preliminary Data

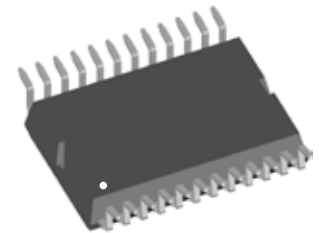
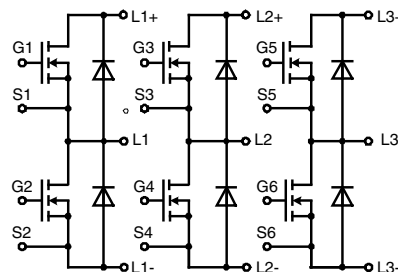

MOSFETs			
Symbol	Conditions	Maximum Ratings	
$V_{DSS}$	$T_{VJ} = 25^{\circ}\text{C to } 150^{\circ}\text{C}$	150	V
$V_{GS}$	continous	$\pm 15$	V
	transient	$\pm 20$	V
$I_{D25}$	$T_C = 25^{\circ}\text{C}$	50	A
$I_{D90}$	$T_C = 90^{\circ}\text{C}$	38	A
$I_{D110}$	$T_C = 110^{\circ}\text{C}$	33	A
$I_{F25}$	$T_C = 25^{\circ}\text{C}$ (diode)	150	A
$I_{F90}$	$T_C = 90^{\circ}\text{C}$ (diode)	85	A
$I_{F110}$	$T_C = 110^{\circ}\text{C}$ (diode)	65	A

## Applications

AC drives

- in automobiles
  - electric power steering
  - starter generator
- in industrial vehicles
  - propulsion drives
  - fork lift drives
- in battery supplied equipment

## Features

- MOSFETs in trench technology:
  - low  $R_{DSon}$
  - optimized intrinsic reverse diode
- package:
  - high level of integration
  - high current capability
  - aux. terminals for MOSFET control
  - terminals for soldering or welding connections
  - isolated DCB ceramic base plate with optimized heat transfer
- Space and weight savings

Symbol	Conditions	Characteristic Values				
		$(T_{VJ} = 25^{\circ}\text{C}, \text{ unless otherwise specified})$				
		min.	typ.	max.		
$R_{DSon}^{1)}$	on chip level at $V_{GS} = 10\text{ V}; I_D = 38\text{ A}$	$T_{VJ} = 25^{\circ}\text{C}$		19	24	$\text{m}\Omega$
		$T_{VJ} = 125^{\circ}\text{C}$		38		$\text{m}\Omega$
$V_{GS(th)}$	$V_{DS} = 20\text{ V}; I_D = 1\text{ mA}$	2.5		4.5	V	
$I_{DSS}$	$V_{DS} = V_{DSS}; V_{GS} = 0\text{ V}$		0.5	5	$\mu\text{A}$ mA	
$I_{GSS}$	$V_{GS} = \pm 20\text{ V}; V_{DS} = 0\text{ V}$			0.2	$\mu\text{A}$	
$Q_g$	$V_{GS} = 10\text{ V}; V_{DS} = 75\text{ V}; I_D = 38\text{ A}$		97		nC	
$Q_{gs}$			29		nC	
$Q_{gd}$			30		nC	
$C_{iss}$	$V_{GS} = 10\text{ V}; V_{DS} = 25\text{ V}; f = 1\text{ MHz}$		5800		pF	
$C_{oss}$			490		pF	
$C_{rss}$			85		pF	
$t_{d(on)}$	inductive load $V_{GS} = 10\text{ V}; V_{DS} = 75\text{ V}$ $I_D = 38\text{ A}; R_{G(on)} = 39\ \Omega; R_{G(off)} = 4.7\ \Omega$ $T_J = 125^{\circ}\text{C}$		120		ns	
$t_r$			50		ns	
$t_{d(off)}$			100		ns	
$t_f$			25		ns	
$E_{on}$			0.25		mJ	
$E_{off}$			0.05		mJ	
$E_{recoff}$		0.02		mJ		
$R_{thJC}$			1.0		K/W	
$R_{thJH}$	with heat transfer paste (IXYS test setup)		1.3	1.6	K/W	

 $^{1)} V_{DS} = I_D \cdot (R_{DS(on)} + 2R_{Pin\ to\ Chip})$ 

IXYS reserves the right to change limits, test conditions and dimensions.

20160610b

**Source-Drain Diode**

Symbol	Conditions	Characteristic Values		
		min.	typ.	max.
( $T_J = 25^\circ\text{C}$ , unless otherwise specified)				
$V_{SD}$	(diode) $I_F = 38\text{ A}$ ; $V_{GS} = 0\text{ V}$	0.85	1.0	V
$t_{rr}$	$I_F = 38\text{ A}$ ; $-di_F/dt = 900\text{ A}/\mu\text{s}$ ; $R_{G(on)} = 39\ \Omega$ ; $V_R = 75\text{ V}$ ; $T_{VJ} = 125^\circ\text{C}$		65	ns
$Q_{RM}$			1.6	$\mu\text{C}$
$I_{RM}$			40	A

**Component**

Symbol	Conditions	Maximum Ratings	
$I_{RMS}$	per pin in main current paths (L+, L-, N-, L1, L2, L3) may be additionally limited by external connections 2 pins for output L1, L2, L3	75	A
$T_J$		-55...+175	$^\circ\text{C}$
$T_{stg}$		-55...+125	$^\circ\text{C}$
$V_{ISOL}$	$I_{ISOL} \leq 1\text{ mA}$ , 50/60 Hz, $f = 1\text{ minute}$	1000	V~
$F_c$	mounting force with clip	50 - 250	N

Symbol	Conditions	Characteristic Values		
		min.	typ.	max.
$R_{pin\ to\ chip}^{1)}$	L+ to L1/L2/L3 or L- to L1/L2/L3		0.9	$\text{m}\Omega$
$C_P$	coupling capacity between shorted pins and back side metallization		160	pF
<b>Weight</b>			25	g

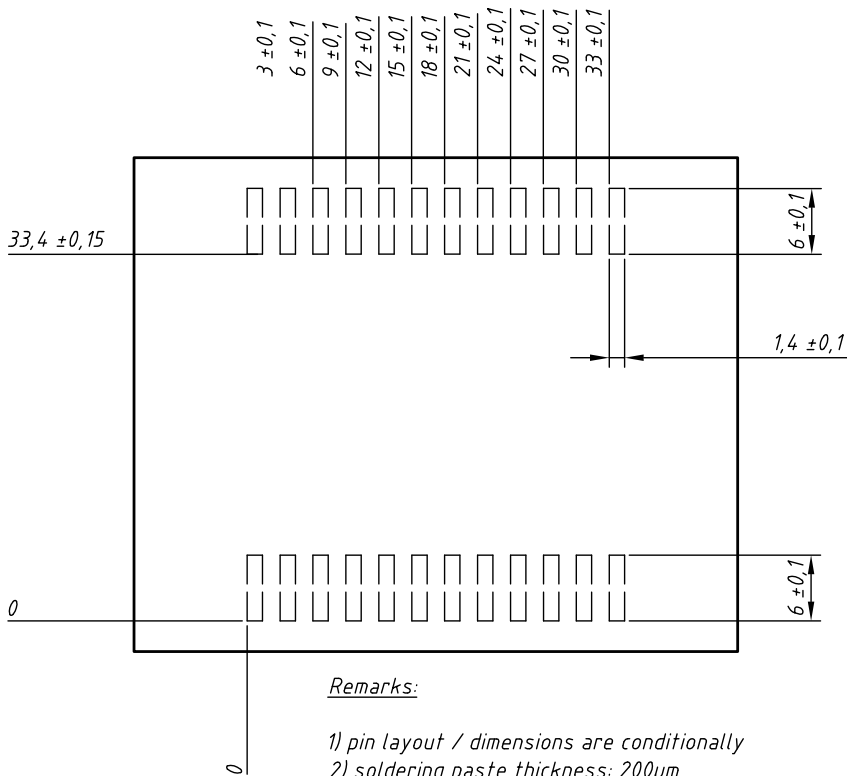
<sup>1)</sup>  $V_{DS} = I_D \cdot (R_{DS(on)} + 2R_{Pin\ to\ Chip})$ 
**Recommended printed circuit board lay-out**

IXYS reserves the right to change limits, test conditions and dimensions.

20160610b

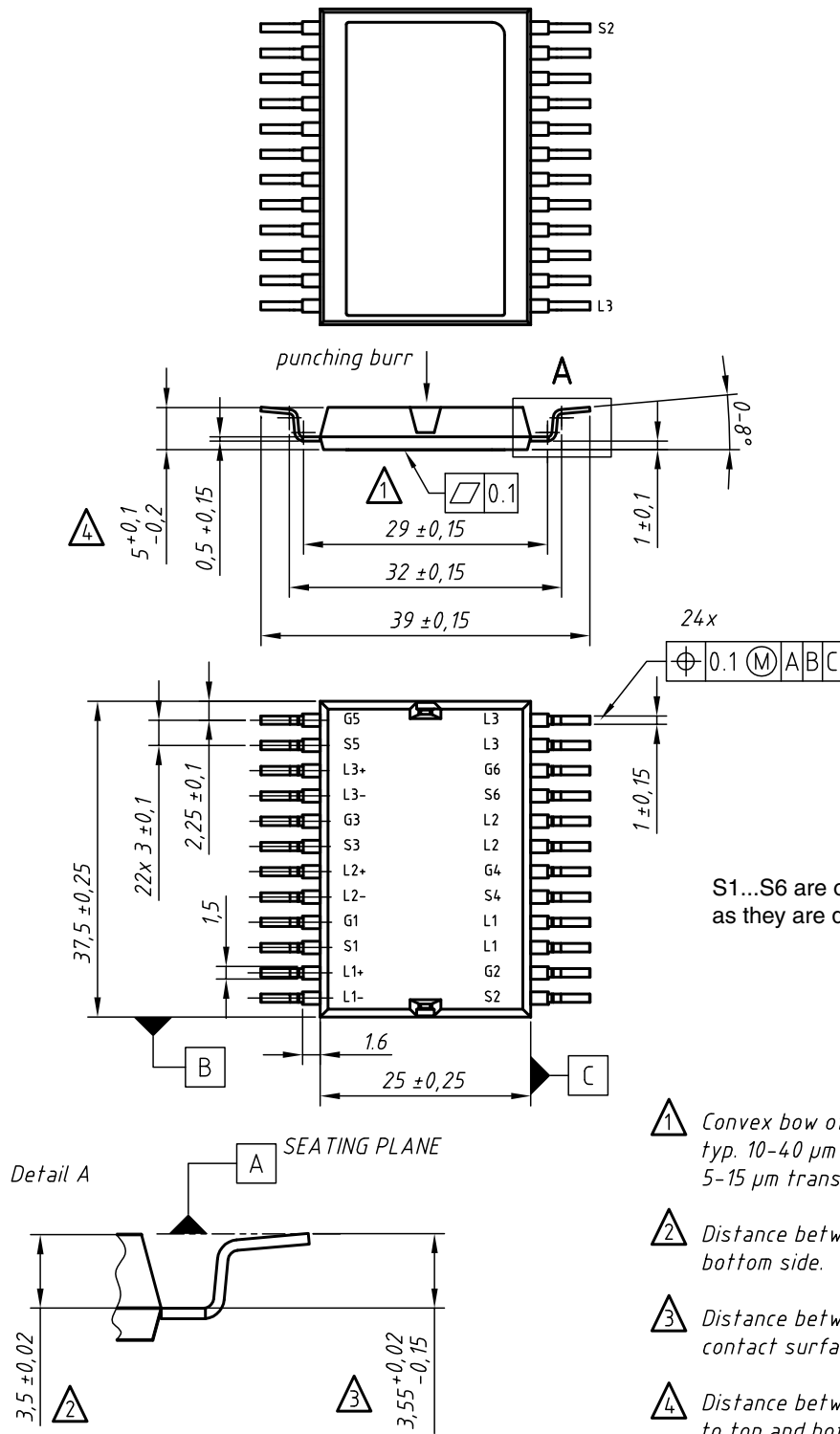

S1...S6 are only for the use of the gate drive as they are designed as Kelvin contacts

- $\triangle 1$  Convex bow of substrate, typ. 10-40  $\mu$ m longitudinal and 5-15  $\mu$ m transversal
- $\triangle 2$  Distance between pin and case bottom side.
- $\triangle 3$  Distance between pin and contact surface.
- $\triangle 4$  Distance between parallel planes aligned to top and bottom sides of the package

**contact pin:**

- galv. tin plating, per pin side: Sn 10...25  $\mu$ m, undercoating Ni 0,2...1  $\mu$ m
- stamping edges may be free of tin
- punching burr:  $\leq 0,05$ mm

Leads	Ordering	Part Name & Packing Unit Marking	Part Marking	Delivering Mode	Base Qty.	Ordering Code
SMD	Standard	GMM 3x60-015X2 - SMD	GMM 3x60-015X2	Blister	28	510635

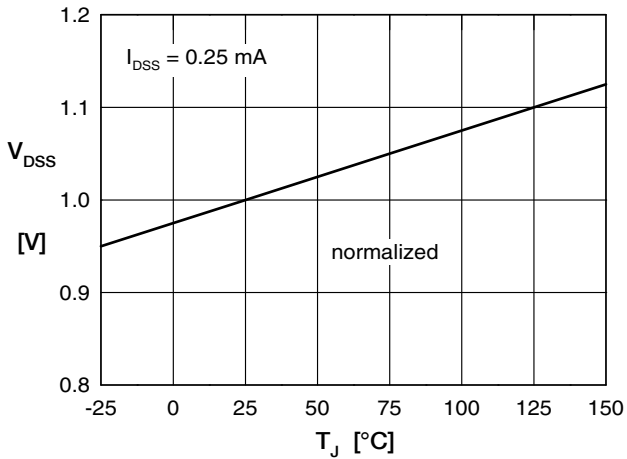

Fig. 1 Drain source breakdown voltage  $V_{DS(sat)}$  vs. junction temperature  $T_{J}$

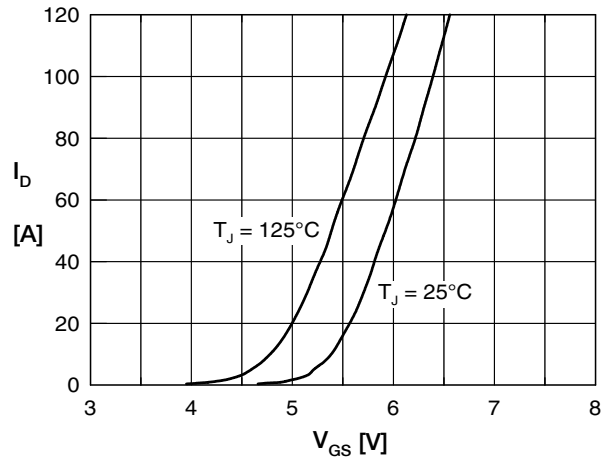

Fig. 2 Typ. transfer characteristics

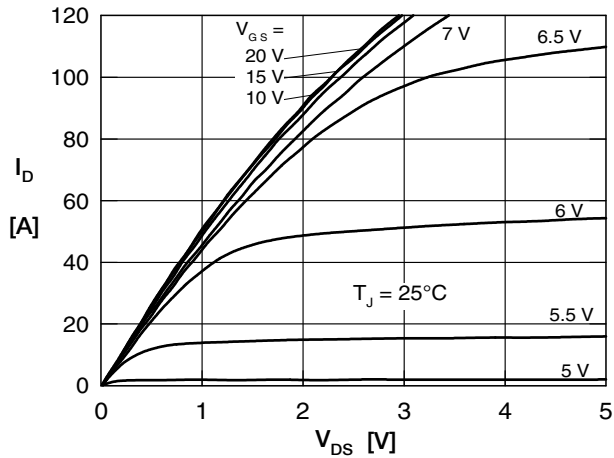

Fig. 3 Typ. output characteristics

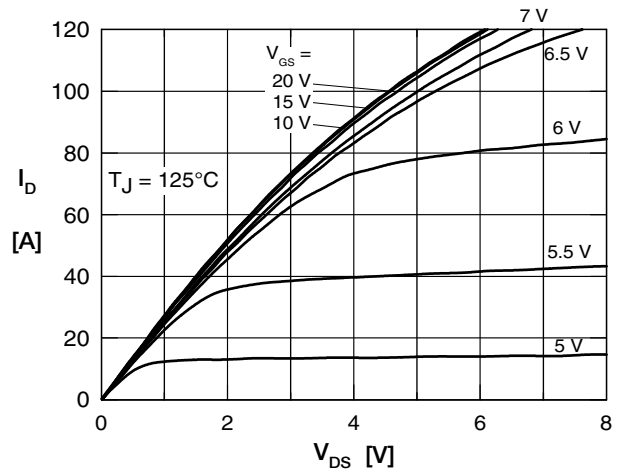

Fig. 4 Typ. output characteristics

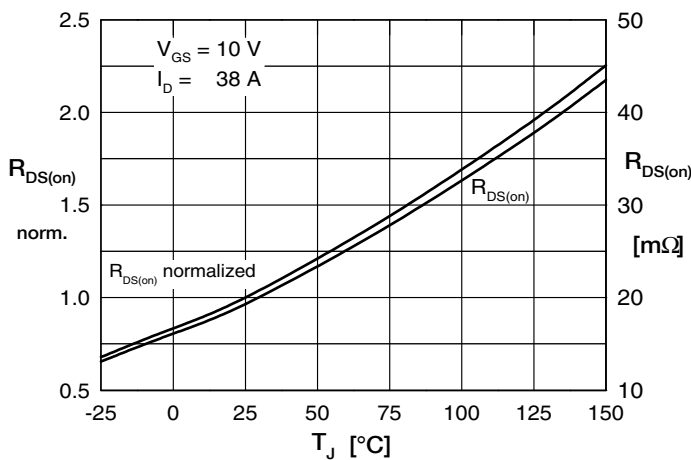

Fig. 5 Drain source on-state resistance  $R_{DS(on)}$  versus junction temperature  $T_{J}$

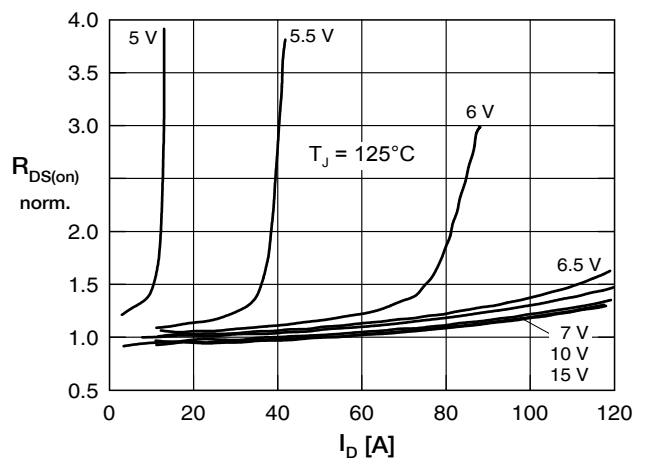

Fig. 6 Drain source on-state resistance  $R_{DS(on)}$  versus  $I_D$

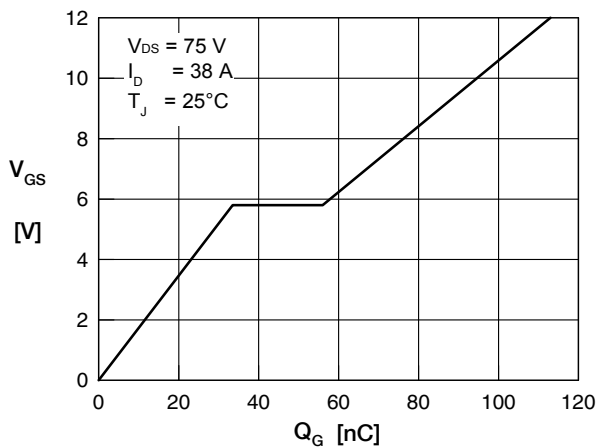

Fig. 7 Typical turn on gate charge

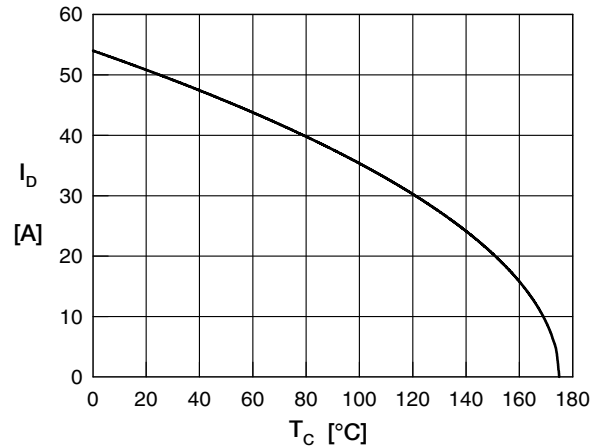
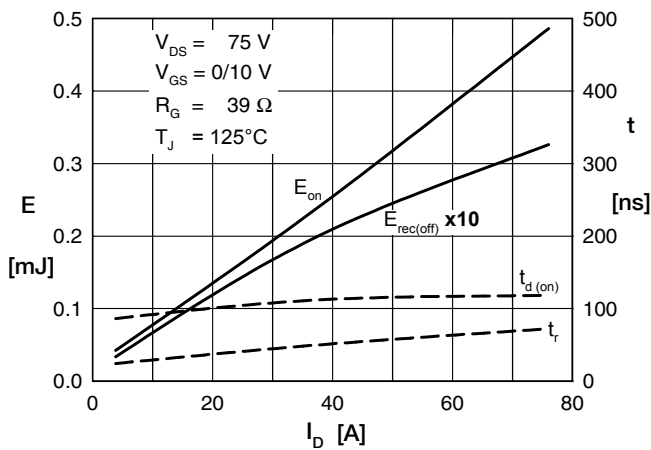

 Fig. 8 Drain current  $I_D$  vs. case temperature  $T_C$ 

Fig. 9 Typ. turn-on energy and switching times versus drain current, inductive switching

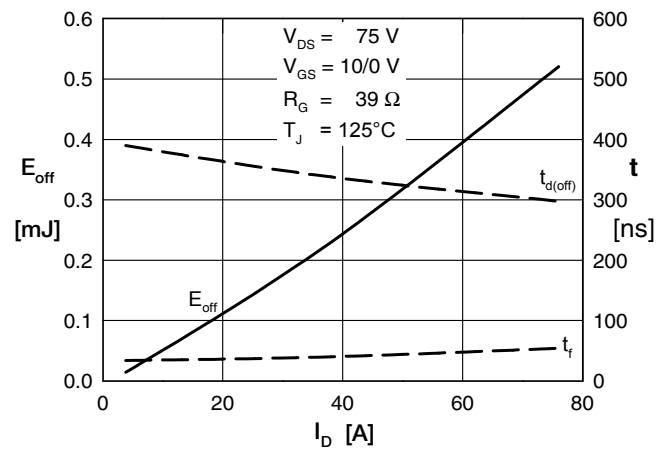

Fig. 10 Typ. turn-off energy and switching times versus drain-current, inductive switching

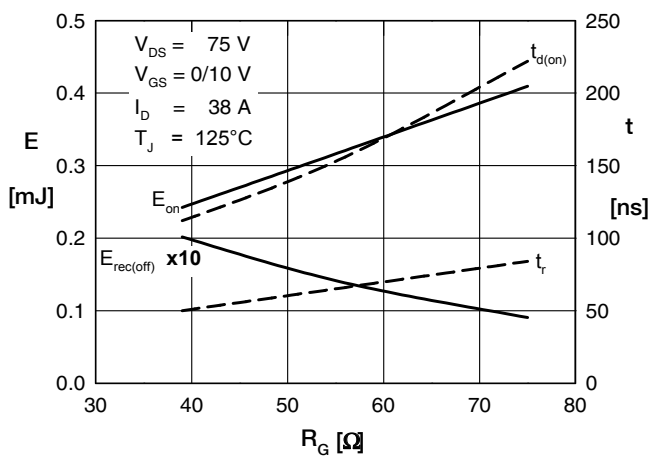

Fig. 11 Typ. turn-on energy and switching times versus gate resistor, inductive switching

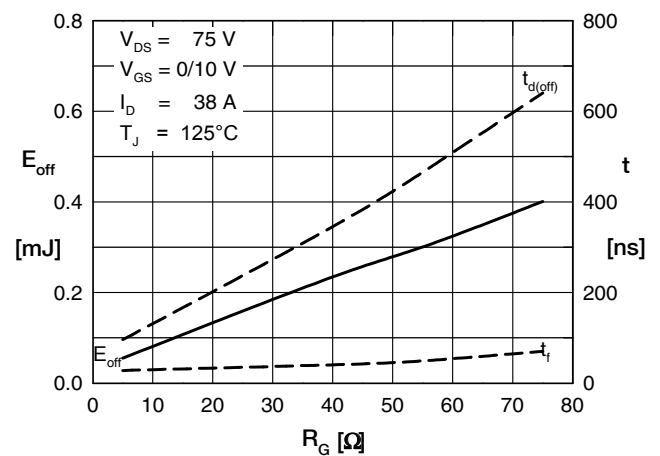

Fig. 12 Typ. turn-off energy and switching times versus gate resistor, inductive switching

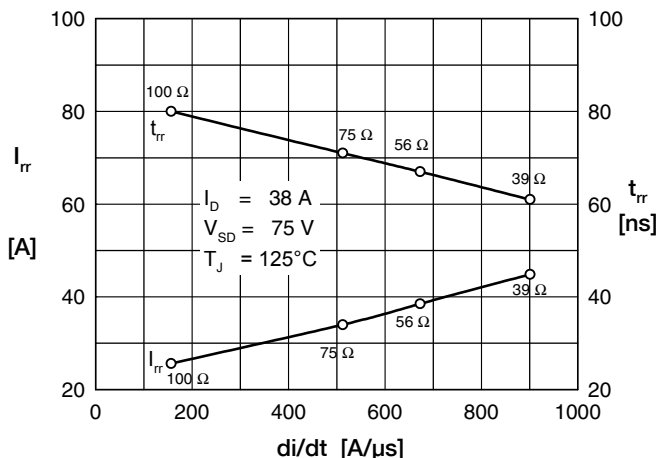

Fig. 13 Typ. reverse recovery characteristics

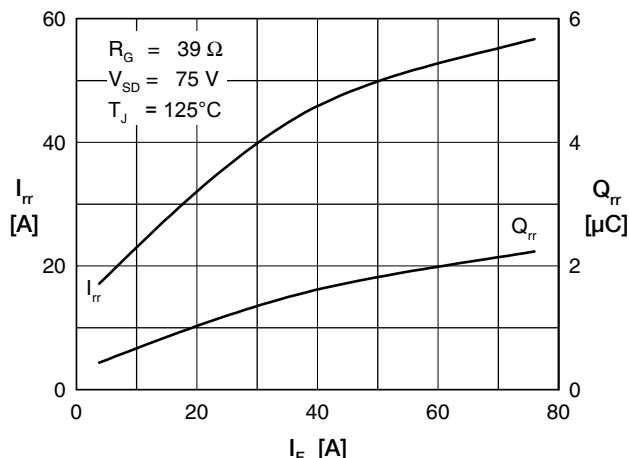

Fig. 14 Typ. reverse recovery characteristics

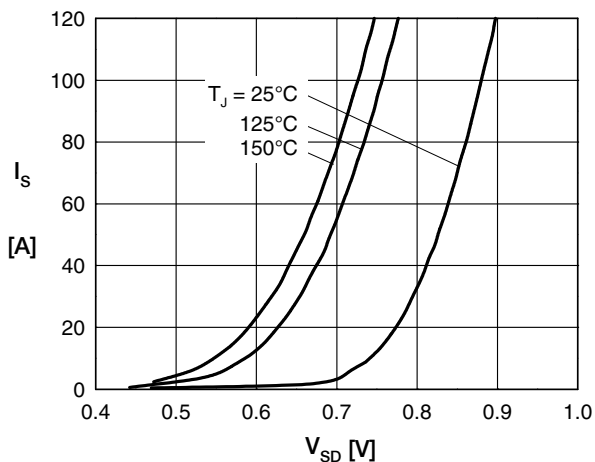

Fig. 15 Source current  $I_S$  versus source drain voltage  $V_{SD}$  (body diode)

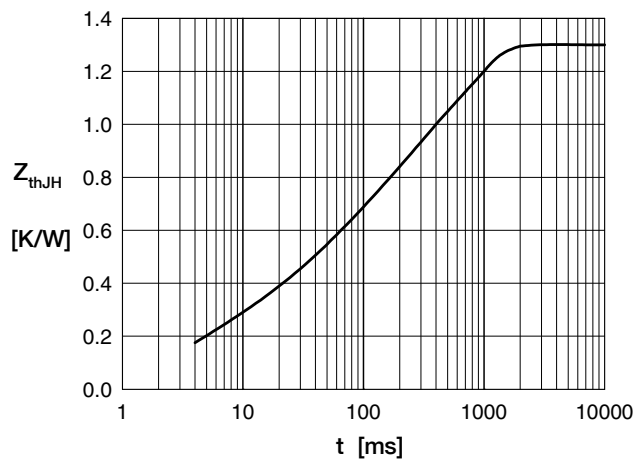

Fig. 16 Typ. thermal impedance junction to heatsink  $Z_{thJH}$  with heat transfer paste (IXYS test setup)

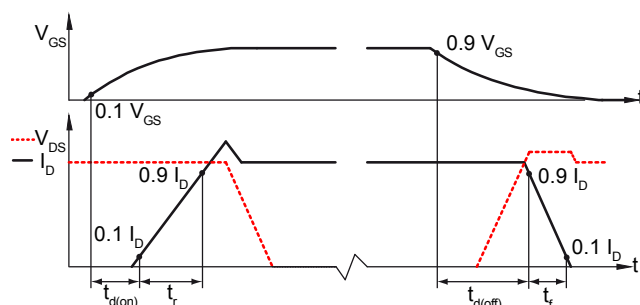

Fig. 17 Definition of switching times

# Mouser Electronics

Authorized Distributor

Click to View Pricing, Inventory, Delivery & Lifecycle Information:

[IXYS:](#)

[GMM3x60-015X2-SMDSAM](#) [GMM3x60-015X2-SMD](#)