

XPT IGBT

$$V_{CES} = 1200V$$

$$I_{C25} = 88A$$

$$V_{CE(sat)} = 1.8V$$

Copack

Part number

IXA60IF1200NA



Backside: isolated

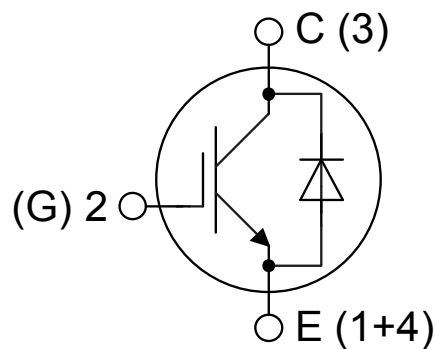

Features / Advantages:

- Easy paralleling due to the positive temperature coefficient of the on-state voltage
- Rugged XPT design (Xtreme light Punch Through) results in:
 - short circuit rated for 10 μ sec.
 - very low gate charge
 - low EMI
 - square RBSOA @ 3x I_c
- Thin wafer technology combined with the XPT design results in a competitive low $V_{CE(sat)}$
- SONIC™ diode
 - fast and soft reverse recovery
 - low operating forward voltage

Applications:

- AC motor drives
- Solar inverter
- Medical equipment
- Uninterruptible power supply
- Air-conditioning systems
- Welding equipment
- Switched-mode and resonant-mode power supplies
- Inductive heating, cookers
- Pumps, Fans

Package: SOT-227B (minibloc)

- Isolation Voltage: 3000 V~
- Industry standard outline
- RoHS compliant
- Epoxy meets UL 94V-0
- Base plate: Copper internally DCB isolated
- Advanced power cycling
- Either emitter terminal can be used as main or Kelvin emitter

IGBT				Ratings			
Symbol	Definition	Conditions	min.	typ.	max.	Unit	
V_{CES}	collector emitter voltage	$T_{VJ} = 25^{\circ}C$			1200	V	
V_{GES}	max. DC gate voltage				± 20	V	
V_{GEM}	max. transient gate emitter voltage				± 30	V	
I_{C25}	collector current	$T_C = 25^{\circ}C$			88	A	
I_{C80}		$T_C = 80^{\circ}C$			56	A	
P_{tot}	total power dissipation	$T_C = 25^{\circ}C$			290	W	
$V_{CE(sat)}$	collector emitter saturation voltage	$I_C = 50A; V_{GE} = 15V$		1.8	2.1	V	
				2.1		V	
$V_{GE(th)}$	gate emitter threshold voltage	$I_C = 2mA; V_{CE} = V_{CE}$	5.4	5.9	6.5	V	
I_{CES}	collector emitter leakage current	$V_{CE} = V_{CES}; V_{GE} = 0V$			0.1	mA	
				0.1		mA	
I_{GES}	gate emitter leakage current	$V_{GE} = \pm 20V$			500	nA	
$Q_{G(on)}$	total gate charge	$V_{CE} = 600V; V_{GE} = 15V; I_C = 50A$		190		nC	
$t_{d(on)}$	turn-on delay time	inductive load $V_{CE} = 600V; I_C = 50A$ $V_{GE} = \pm 15V; R_G = 15\Omega$	$T_{VJ} = 125^{\circ}C$		70	ns	
t_r	current rise time				40	ns	
$t_{d(off)}$	turn-off delay time				250	ns	
t_f	current fall time				100	ns	
E_{on}	turn-on energy per pulse				4.5	mJ	
E_{off}	turn-off energy per pulse				5.5	mJ	
RBSOA	reverse bias safe operating area	$V_{GE} = \pm 15V; R_G = 15\Omega$					
I_{CM}		$V_{CEmax} = 1200V$			150	A	
SCSOA	short circuit safe operating area	$V_{CEmax} = 1200V$					
t_{sc}	short circuit duration	$V_{CE} = 900V; V_{GE} = \pm 15V$			10	μs	
I_{sc}	short circuit current	$R_G = 15\Omega; \text{non-repetitive}$		200		A	
R_{thJC}	thermal resistance junction to case				0.43	K/W	
R_{thCH}	thermal resistance case to heatsink			0.10		K/W	
Diode							
V_{RRM}	max. repetitive reverse voltage				1200	V	
I_{F25}	forward current				85	A	
I_{F80}					51	A	
V_F	forward voltage	$I_F = 60A$			2.20	V	
				1.95		V	
I_R	reverse current	$V_R = V_{RRM}$			*	mA	
	* not applicable, see Ices at IGBT				*	mA	
Q_{rr}	reverse recovery charge	$V_R = 600V$ $-di_F/dt = E+03 A/\mu s$ $I_F = 60A; V_{GE} = 0V$	$T_{VJ} = 125^{\circ}C$		8	μC	
I_{RM}	max. reverse recovery current				60	A	
t_{rr}	reverse recovery time				350	ns	
E_{rec}	reverse recovery energy				2.5	mJ	
R_{thJC}	thermal resistance junction to case				0.6	K/W	
R_{thCH}	thermal resistance case to heatsink			0.10		K/W	

Package SOT-227B (minibloc)		Ratings				
Symbol	Definition	Conditions	min.	typ.	max.	Unit
I_{RMS}	RMS current	per terminal ¹⁾			150	A
T_{VJ}	virtual junction temperature		-40		150	°C
T_{op}	operation temperature		-40		125	°C
T_{stg}	storage temperature		-40		150	°C
Weight				30		g
M_D	mounting torque		1.1		1.5	Nm
M_T	terminal torque		1.1		1.5	Nm
$d_{Spp/App}$	creepage distance on surface striking distance through air	terminal to terminal	10.5	3.2		mm
$d_{Spb/Apb}$		terminal to backside	8.6	6.8		mm
V_{ISOL}	isolation voltage	t = 1 second			3000	V
		t = 1 minute	50/60 Hz, RMS; $I_{ISOL} \leq 1$ mA		2500	V

¹⁾ I_{RMS} is typically limited by the pin-to-chip resistance (1); or by the current capability of the chip (2). In case of (1) and a product with multiple pins for one chip-potential, the current capability can be increased by connecting the pins as one contact.

Product Marking

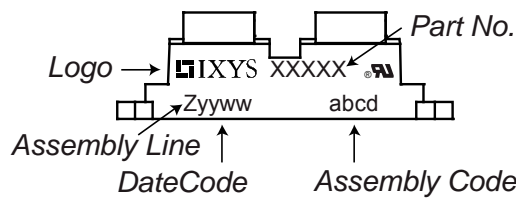

Part description

- I = IGBT
- X = XPT IGBT
- A = Gen 1 / std
- 60 = Current Rating [A]
- IF = Copack
- 1200 = Reverse Voltage [V]
- NA = SOT-227B (minibloc)

Ordering	Ordering Number	Marking on Product	Delivery Mode	Quantity	Code No.
Standard	IXA60IF1200NA	IXA60IF1200NA	Tube	10	508765

Similar Part	Package	Voltage class
IXA70I1200NA	SOT-227B (minibloc)	1200

Equivalent Circuits for Simulation

* on die level

$T_{VJ} = 150$ °C

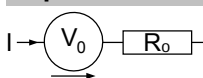

$V_{0\ max}$ threshold voltage

$R_{0\ max}$ slope resistance *

	IGBT	Diode	
$V_{0\ max}$	1.1	1.25	V
$R_{0\ max}$	28	14.2	mΩ

Outlines SOT-227B (minibloc)

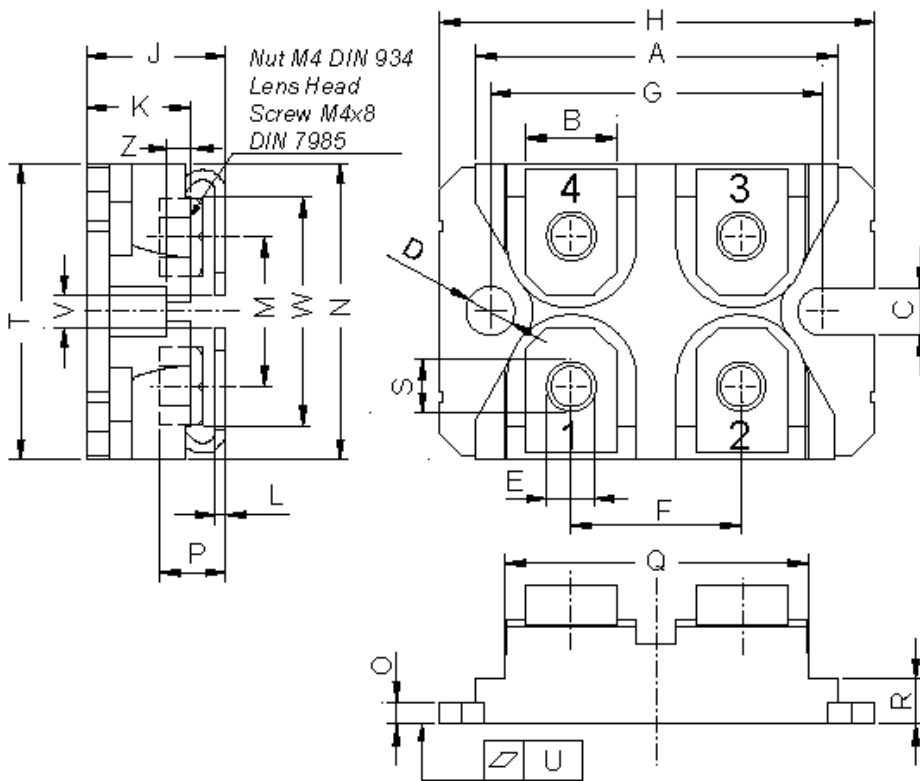

Dim.	Millimeter		Inches	
	min	max	min	max
A	31.50	31.88	1.240	1.255
B	7.80	8.20	0.307	0.323
C	4.09	4.29	0.161	0.169
D	4.09	4.29	0.161	0.169
E	4.09	4.29	0.161	0.169
F	14.91	15.11	0.587	0.595
G	30.12	30.30	1.186	1.193
H	37.80	38.23	1.488	1.505
J	11.68	12.22	0.460	0.481
K	8.92	9.60	0.351	0.378
L	0.74	0.84	0.029	0.033
M	12.50	13.10	0.492	0.516
N	25.15	25.42	0.990	1.001
O	1.95	2.13	0.077	0.084
P	4.95	6.20	0.195	0.244
Q	26.54	26.90	1.045	1.059
R	3.94	4.42	0.155	0.167
S	4.55	4.85	0.179	0.191
T	24.59	25.25	0.968	0.994
U	-0.05	0.10	-0.002	0.004
V	3.20	5.50	0.126	0.217
W	19.81	21.08	0.780	0.830
Z	2.50	2.70	0.098	0.106

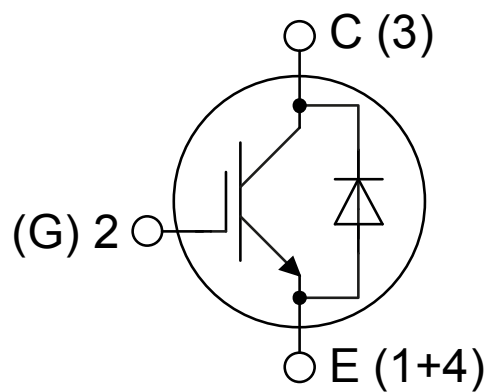

IGBT

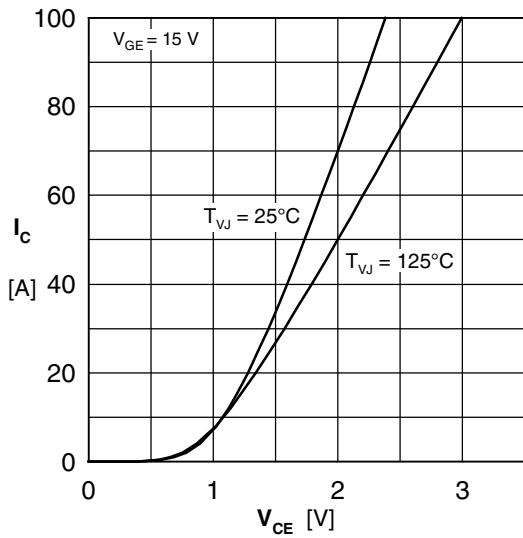

Fig. 1 Typ. output characteristics

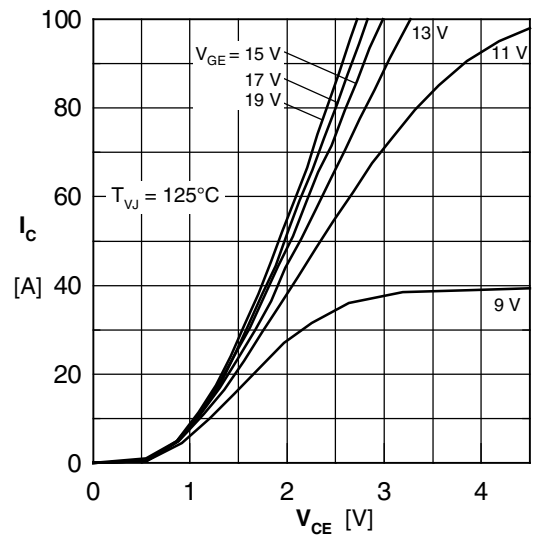

Fig. 2 Typ. output characteristics

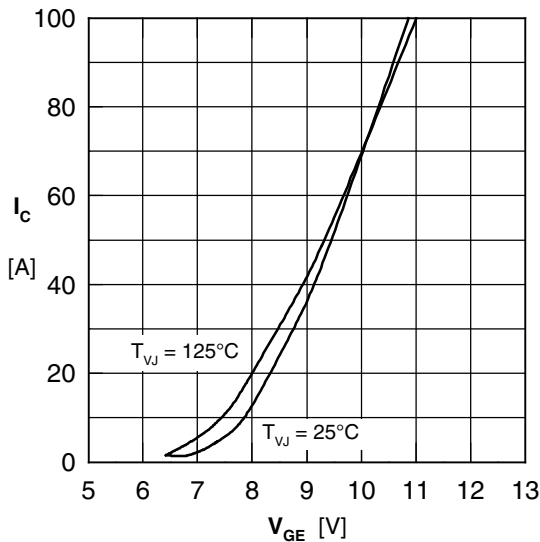

Fig. 3 Typ. transfer characteristics

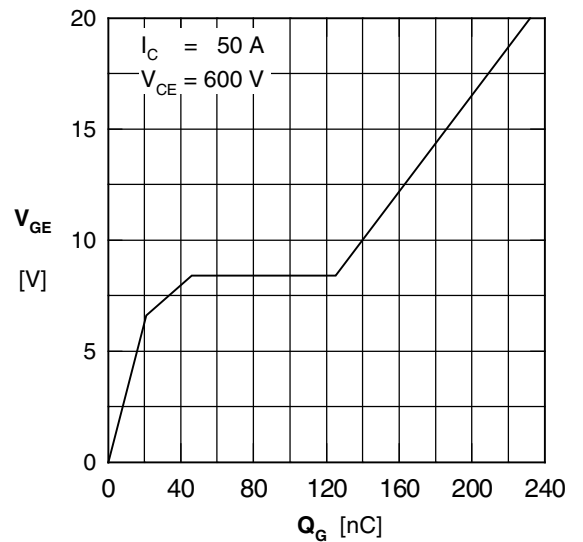

Fig. 4 Typ. turn-on gate charge

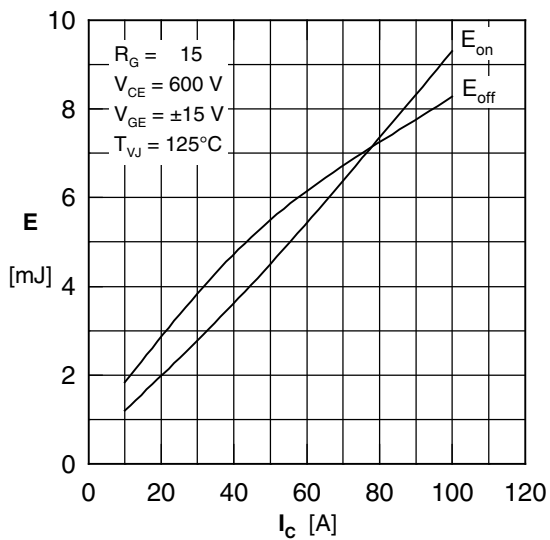

Fig. 5 Typ. switching energy vs. collector current

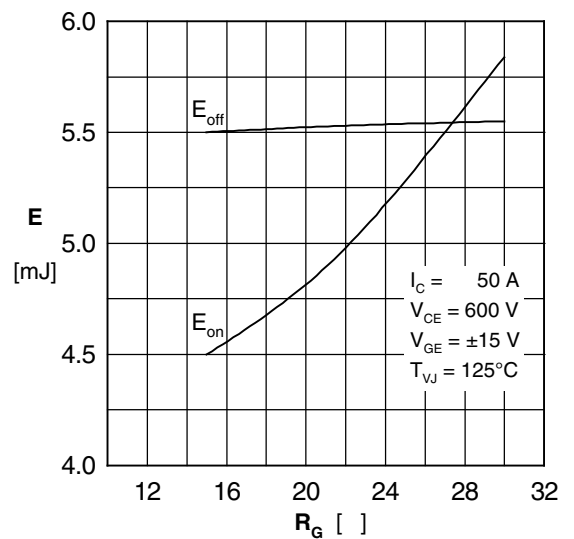

Fig. 6 Typ. switching energy vs. gate resistance

Diode

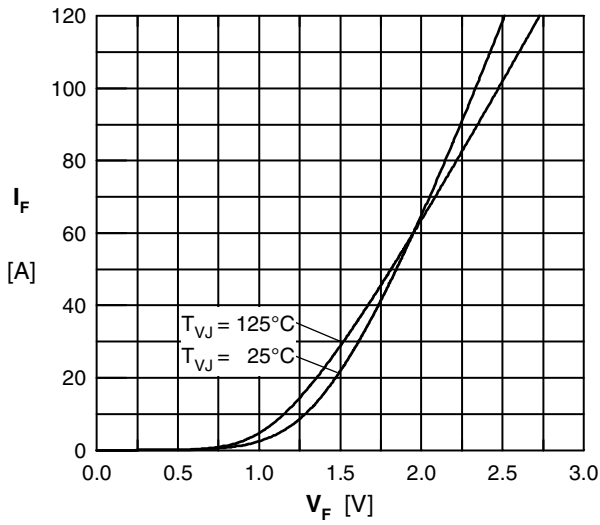

Fig. 7 Typ. Forward current versus V_F

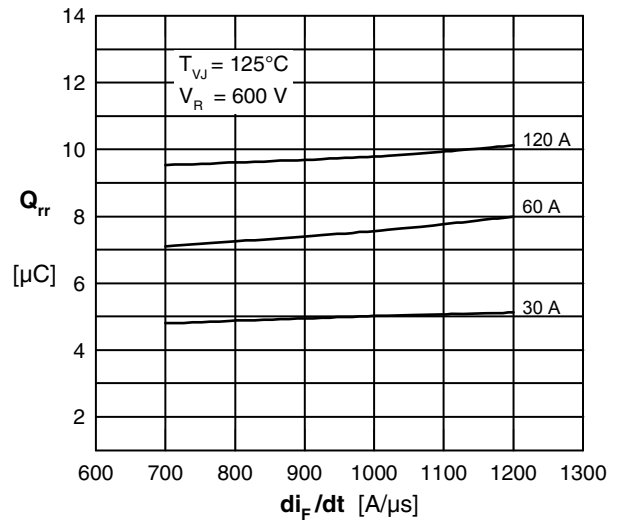

Fig. 8 Typ. reverse recov.charge Q_{rr} vs. di/dt

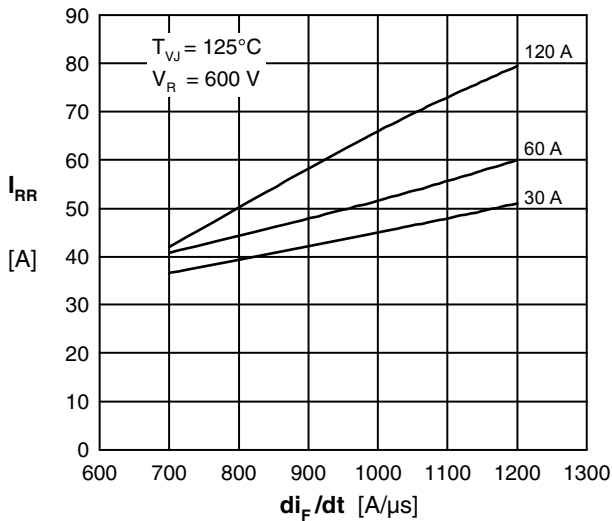

Fig. 9 Typ. peak reverse current I_{RM} vs. di/dt

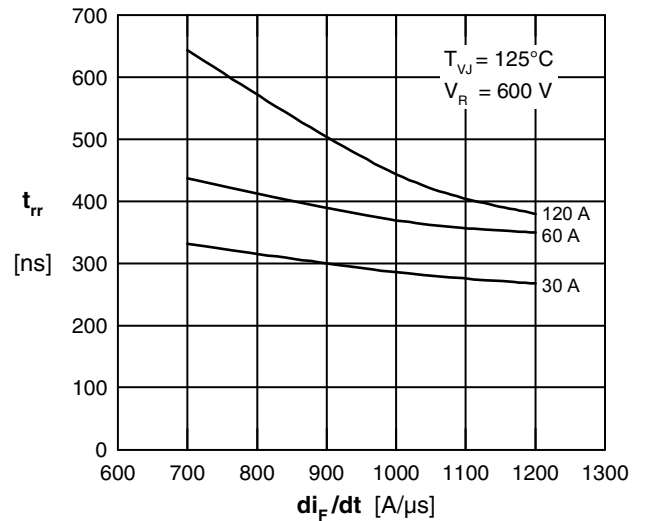

Fig. 10 Typ. recovery time t_{rr} versus di/dt

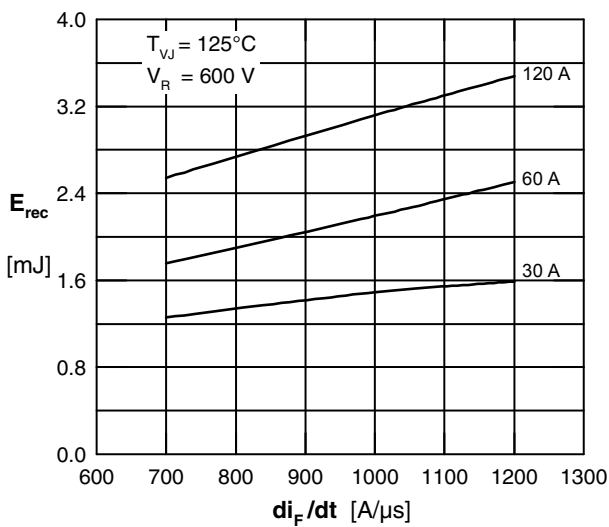

Fig. 11 Typ. recovery energy E_{rec} versus di/dt

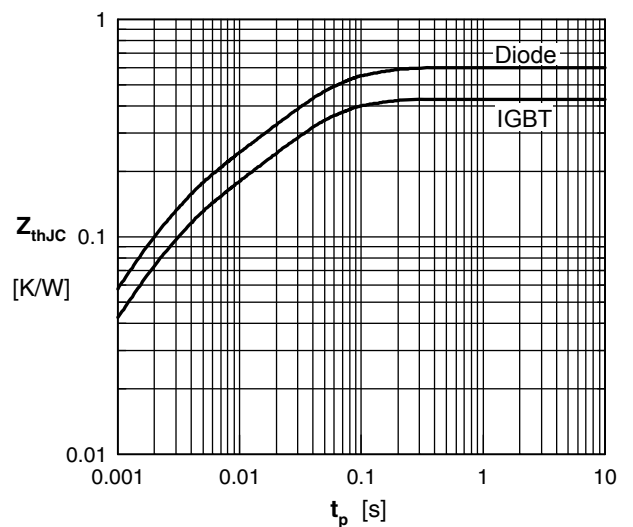

Fig. 12 Typ. transient thermal impedance

Mouser Electronics

Authorized Distributor

Click to View Pricing, Inventory, Delivery & Lifecycle Information:

[IXYS:](#)

[IXA60IF1200NA](#)