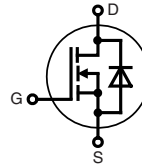
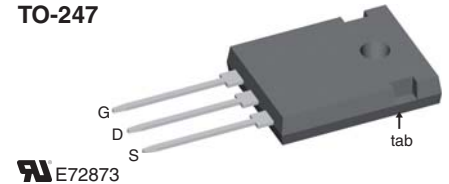

CoolMOS™ 1) Power MOSFET

Low $R_{DS(on)}$, high V_{DSS}
Superjunction MOSFET

$V_{DSS} = 600\text{ V}$
 $I_{D25} = 47\text{ A}$
 $R_{DS(on) \text{ max}} = 70\text{ m}\Omega$

TO-247

MOSFET			
Symbol	Conditions	Maximum Ratings	
V_{DSS}	$T_{VJ} = 25^\circ\text{C}$	600	V
V_{GS}		± 20	V
I_{D25}	$T_C = 25^\circ\text{C}$	47	A
I_{D100}	$T_C = 100^\circ\text{C}$	30	A
E_{AS}	single pulse $I_D = 10\text{ A}; T_C = 25^\circ\text{C}$	1800	mJ
E_{AR}	repetitive $I_D = 20\text{ A}; T_C = 25^\circ\text{C}$	tbd	mJ
dV/dt	MOSFET dV/dt ruggedness $V_{DS} = 0 \dots 480\text{ V}$	tbd	V/ns

Features

- 3rd generation Superjunction power MOSFET
- high blocking capability
- lowest resistance
- avalanche rated for unclamped inductive switching (UIS)
- low thermal resistance due to reduced chip thickness

Applications

- Switched mode power supplies (SMPS)
- Uninterruptible power supplies (UPS)
- Power factor correction (PFC)
- Welding
- Inductive heating

Symbol	Conditions	Characteristic Values			
		$(T_{VJ} = 25^\circ\text{C}, \text{ unless otherwise specified})$			
		min.	typ.	max.	
$R_{DS(on)}$	$V_{GS} = 10\text{ V}; I_D = I_{D100} \text{ }^\ominus$		60	70	m Ω
$V_{GS(th)}$	$V_{DS} = V_{GS}; I_D = 2\text{ mA}$	2		4	V
I_{DSS}	$V_{DS} = V_{DSS}; V_{GS} = 0\text{ V}$			25	μA
				250	μA
I_{GSS}	$V_{GS} = \pm 20\text{ V}; V_{DS} = 0\text{ V}$			± 100	nA
C_{iss}	} $V_{GS} = 0\text{ V}; V_{DS} = 100\text{ V}$ $f = 1\text{ MHz}$		tbd		pF
C_{oss}				tbd	
Q_g	} $V_{GS} = 0\text{ to }10\text{ V}; V_{DS} = 350\text{ V}; I_D = 40\text{ A}$		255	650	nC
Q_{gs}			30		nC
Q_{gd}			110		nC
$t_{d(on)}$	} $V_{GS} = 10\text{ V}; V_{DS} = 380\text{ V}$ $I_D = 47\text{ A}; R_G = 4.7\ \Omega$		20		ns
t_r			27		ns
$t_{d(off)}$			111		ns
t_f			10		ns
R_{thJC}				0.3	K/W

[⊖] Pulse test, $t \leq 300\ \mu\text{s}$, duty cycle $d \leq 2\%$

¹⁾ CoolMOS™ is a trademark of Infineon Technologies AG.

Source-Drain Diode

Symbol	Conditions	Characteristic Values		
		min.	typ.	max.
I_S	$V_{GS} = 0 V$			A
V_{SD}	$I_F = 40 A; V_{GS} = 0 V$			V
t_{rr} Q_{RM} I_{RM}	} $I_F = 40 A; -di_F/dt = 100 A/\mu s; V_R = 640 V$			ns μC A

($T_{VJ} = 25^\circ C$, unless otherwise specified)

Component

Symbol	Conditions	Maximum Ratings	
T_{VJ}	operating	-55...+150	$^\circ C$
T_{stg}		-55...+150	$^\circ C$
M_d	mounting torque	1.13	Nm

Symbol	Conditions	Characteristic Values		
		min.	typ.	max.
R_{thCH}	with heatsink compound		tdb	K/W
Weight			2.7	g

TO-247 Outline

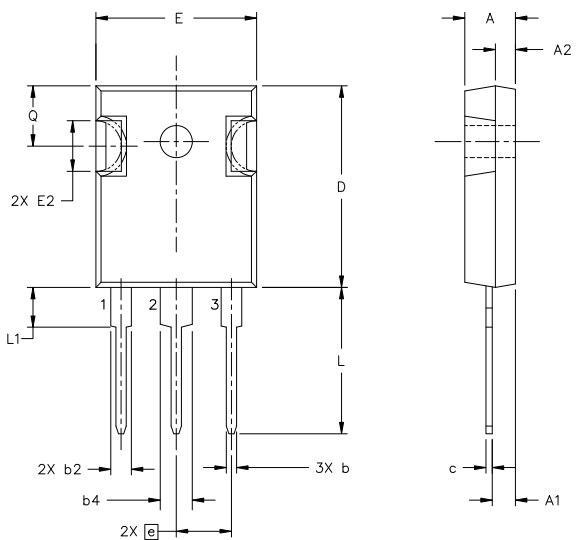

Symbol	Inches		Millimeters	
	min	max	min	max
A	0.185	0.209	4.70	5.30
A1	0.087	0.102	2.21	2.59
A2	0.059	0.098	1.50	2.49
D	0.819	0.845	20.79	21.45
E	0.610	0.640	15.48	16.24
E2	0.170	0.216	4.31	5.48
e	0.215 BSC		5.46 BSC	
L	0.780	0.800	19.80	20.30
L1	-	0.177	-	4.49
ØP	0.140	0.144	3.55	3.65
Q	0.212	0.244	5.38	6.19
S	0.242 BSC		6.14 BSC	
b	0.039	0.055	0.99	1.40
b2	0.065	0.094	1.65	2.39
b4	0.102	0.135	2.59	3.43
c	0.015	0.035	0.38	0.89
D1	0.515	-	13.07	-
D2	0.020	0.053	0.51	1.35
E1	0.530	-	13.45	-
ØP1	-	0.291	-	7.39

IXYS reserves the right to change limits, test conditions and dimensions.

20080523a

Fig. 1. Output Characteristics @ 25 Deg. C

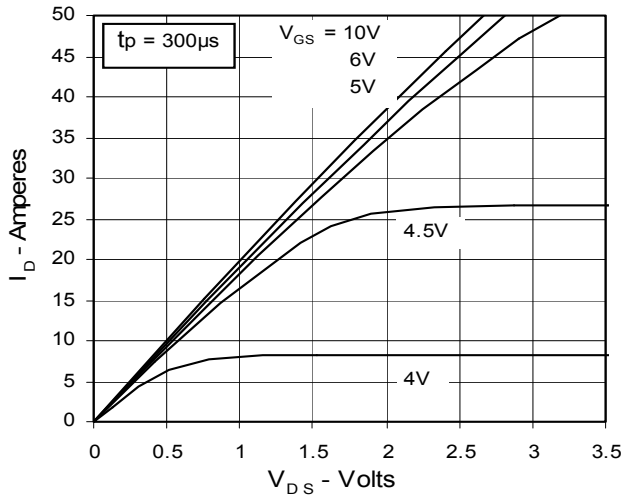

Fig. 2. Extended Output Characteristics @ 25 deg. C

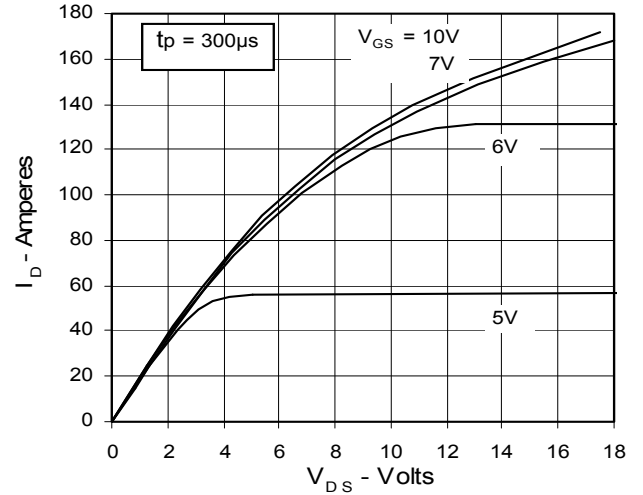

Fig. 3. Output Characteristics @ 125 Deg. C

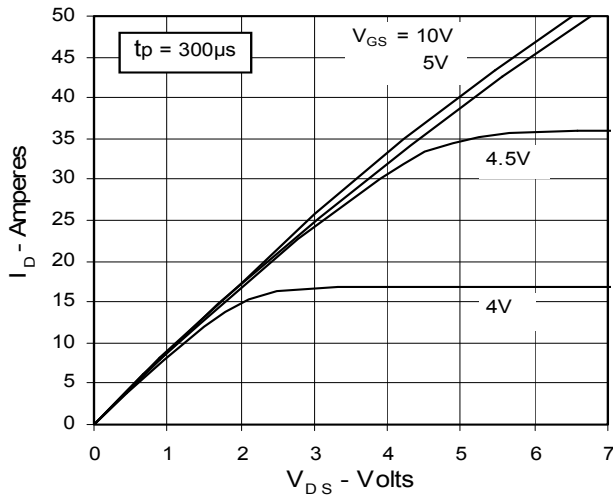

Fig. 4. R_DS(on) Normalized to I_D100 Value vs. Junction Temperature

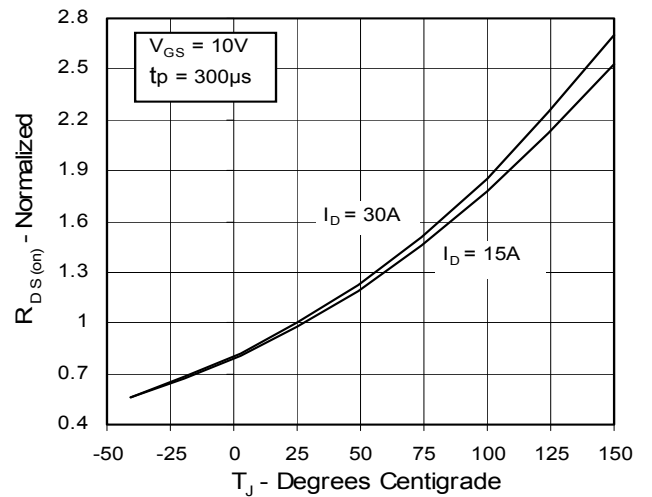

Fig. 5. R_DS(on) Normalized to I_D100 Value vs. I_D

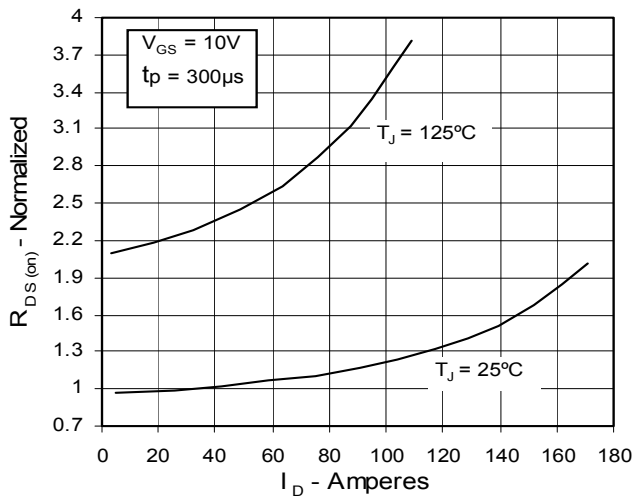

Fig. 6. Drain Current vs. Case Temperature

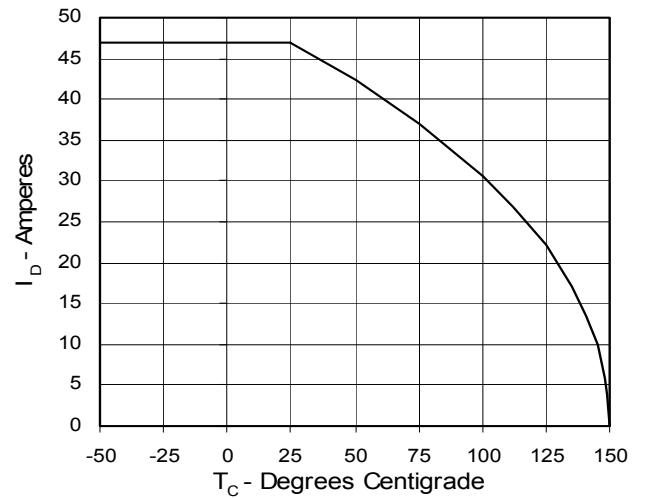

Fig. 7. Input Admittance

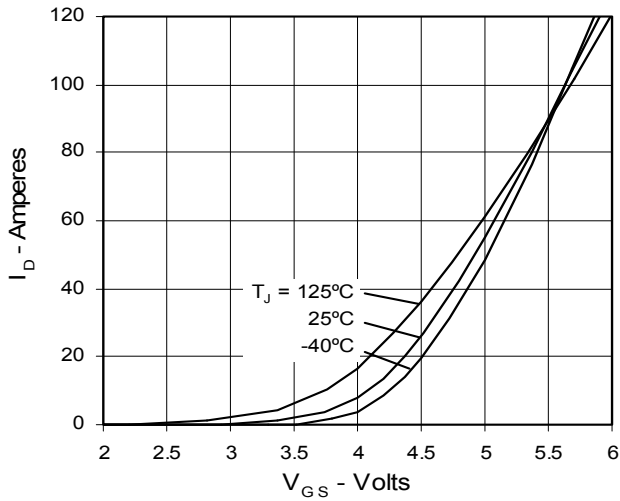

Fig. 8. Transconductance

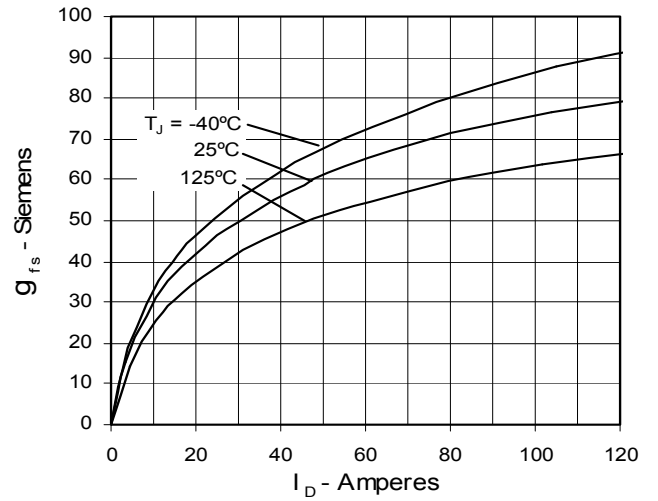

Fig. 9. Source Current vs. Source-To-Drain Voltage

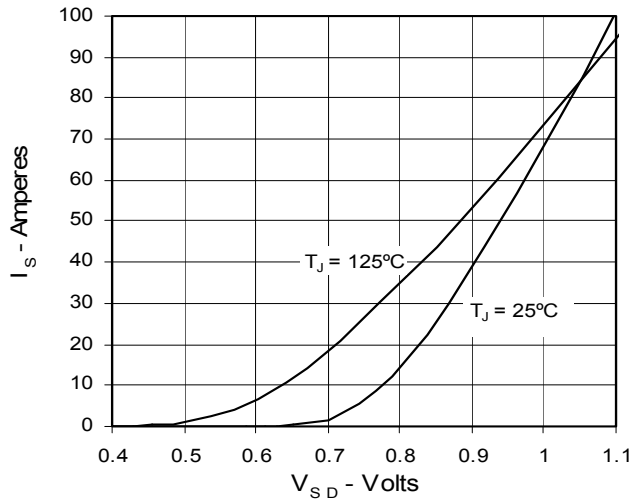

Fig. 10. Gate Charge

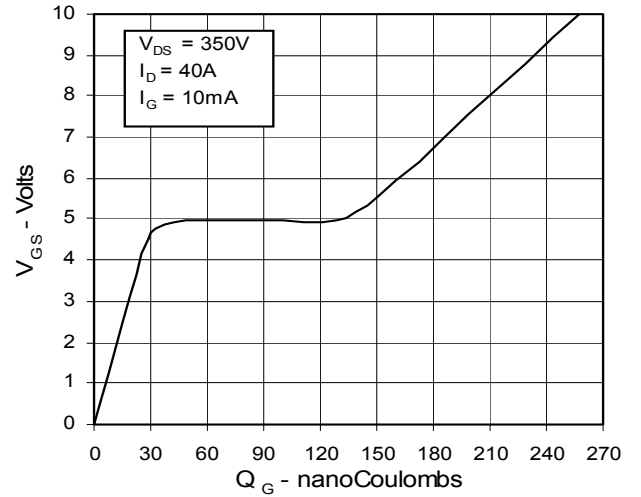

Fig. 11. Capacitance

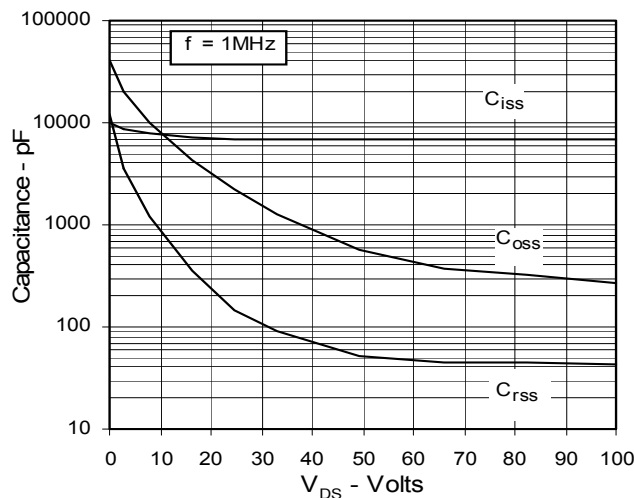
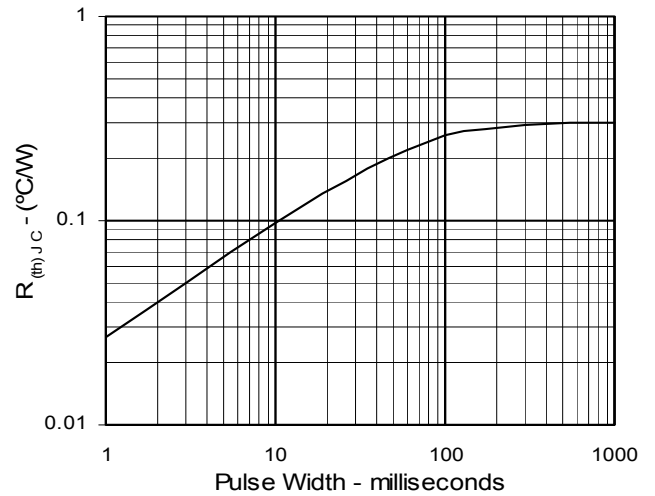

Fig. 12. Maximum Transient Thermal Resistance



Mouser Electronics

Authorized Distributor

Click to View Pricing, Inventory, Delivery & Lifecycle Information:

[IXYS:](#)

[IXKH47N60C](#)