

Standard Rectifier Module

3~ Rectifier	
V_{RRM}	= 800 V
I_{DAV}	= 125 A
I_{FSM}	= 1200 A

3~ Rectifier Bridge

Part number

VUO110-08NO7

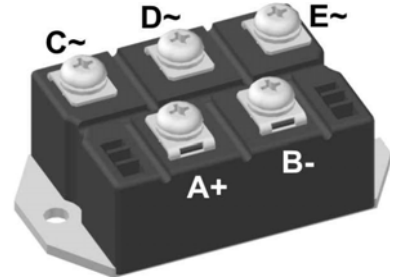

E72873

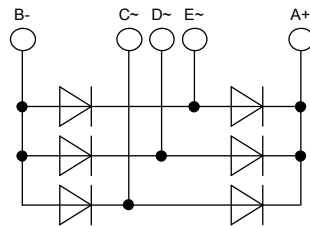

Features / Advantages:

- Package with DCB ceramic
- Improved temperature and power cycling
- Planar passivated chips
- Very low forward voltage drop
- Very low leakage current

Applications:

- Diode for main rectification
- For three phase bridge configurations
- Supplies for DC power equipment
- Input rectifiers for PWM inverter
- Battery DC power supplies
- Field supply for DC motors

Package: PWS-E

- Industry standard outline
- RoHS compliant
- Easy to mount with two screws
- Base plate: Copper internally DCB isolated
- Advanced power cycling

Rectifier				Ratings			
Symbol	Definition	Conditions		min.	typ.	max.	Unit
V_{RSM}	max. non-repetitive reverse blocking voltage					900	V
V_{RRM}	max. repetitive reverse blocking voltage					800	V
I_R	reverse current	$V_R = 800$ V	$T_{VJ} = 25^\circ\text{C}$			100	μA
		$V_R = 800$ V	$T_{VJ} = 150^\circ\text{C}$			2	mA
V_F	forward voltage drop	$I_F = 50$ A	$T_{VJ} = 25^\circ\text{C}$			1.13	V
						1.46	V
		$I_F = 150$ A	$T_{VJ} = 125^\circ\text{C}$			1.04	V
						1.47	V
I_{DAV}	bridge output current	$T_C = 110^\circ\text{C}$ rectangular $d = \frac{1}{3}$	$T_{VJ} = 150^\circ\text{C}$			125	A
V_{FO}	threshold voltage					0.79	V
r_F	slope resistance					4.5	m Ω
R_{thJC}	thermal resistance junction to case					0.7	K/W
R_{thCH}	thermal resistance case to heatsink				0.3		K/W
P_{tot}	total power dissipation			$T_C = 25^\circ\text{C}$		175	W
I_{FSM}	max. forward surge current	$t = 10$ ms; (50 Hz), sine	$T_{VJ} = 45^\circ\text{C}$			1.20	kA
						1.30	kA
		$t = 8,3$ ms; (60 Hz), sine	$V_R = 0$ V			1.02	kA
						1.10	kA
I^2t	value for fusing	$t = 10$ ms; (50 Hz), sine	$T_{VJ} = 45^\circ\text{C}$			7.20	kA ² s
						6.98	kA ² s
		$t = 8,3$ ms; (60 Hz), sine	$V_R = 0$ V			5.20	kA ² s
						5.04	kA ² s
C_J	junction capacitance	$V_R = 400$ V; $f = 1$ MHz	$T_{VJ} = 25^\circ\text{C}$		37		pF

Package PWS-E			Ratings			
Symbol	Definition	Conditions	min.	typ.	max.	Unit
I_{RMS}	RMS current	per terminal			200	A
T_{stg}	storage temperature		-40		125	°C
T_{VJ}	virtual junction temperature		-40		150	°C
Weight				284		g
M_D	mounting torque		4.25		5.75	Nm
M_T	terminal torque		4.25		5.75	Nm
$d_{Spp/App}$	creepage distance on surface striking distance through air	terminal to terminal	12.0			mm
$d_{Spb/Apb}$		terminal to backside	26.0			mm
V_{ISOL}	isolation voltage	t = 1 second	3000			V
		t = 1 minute	2500			V

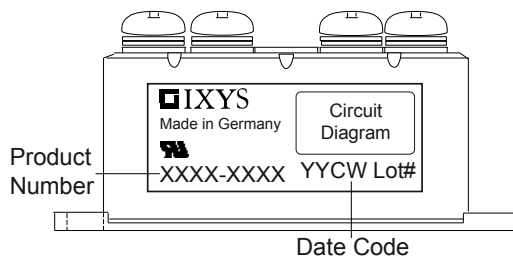

Ordering	Part Number	Marking on Product	Delivery Mode	Quantity	Code No.
Standard	VUO110-08NO7	VUO110-08NO7	Box	5	462365

Equivalent Circuits for Simulation

* on die level

$T_{VJ} = 150\text{ °C}$

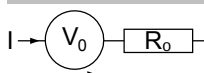

Rectifier

$V_{0\ max}$	threshold voltage	0.79	V
$R_{0\ max}$	slope resistance *	3.3	mΩ

Outlines PWS-E

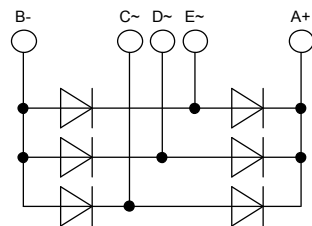
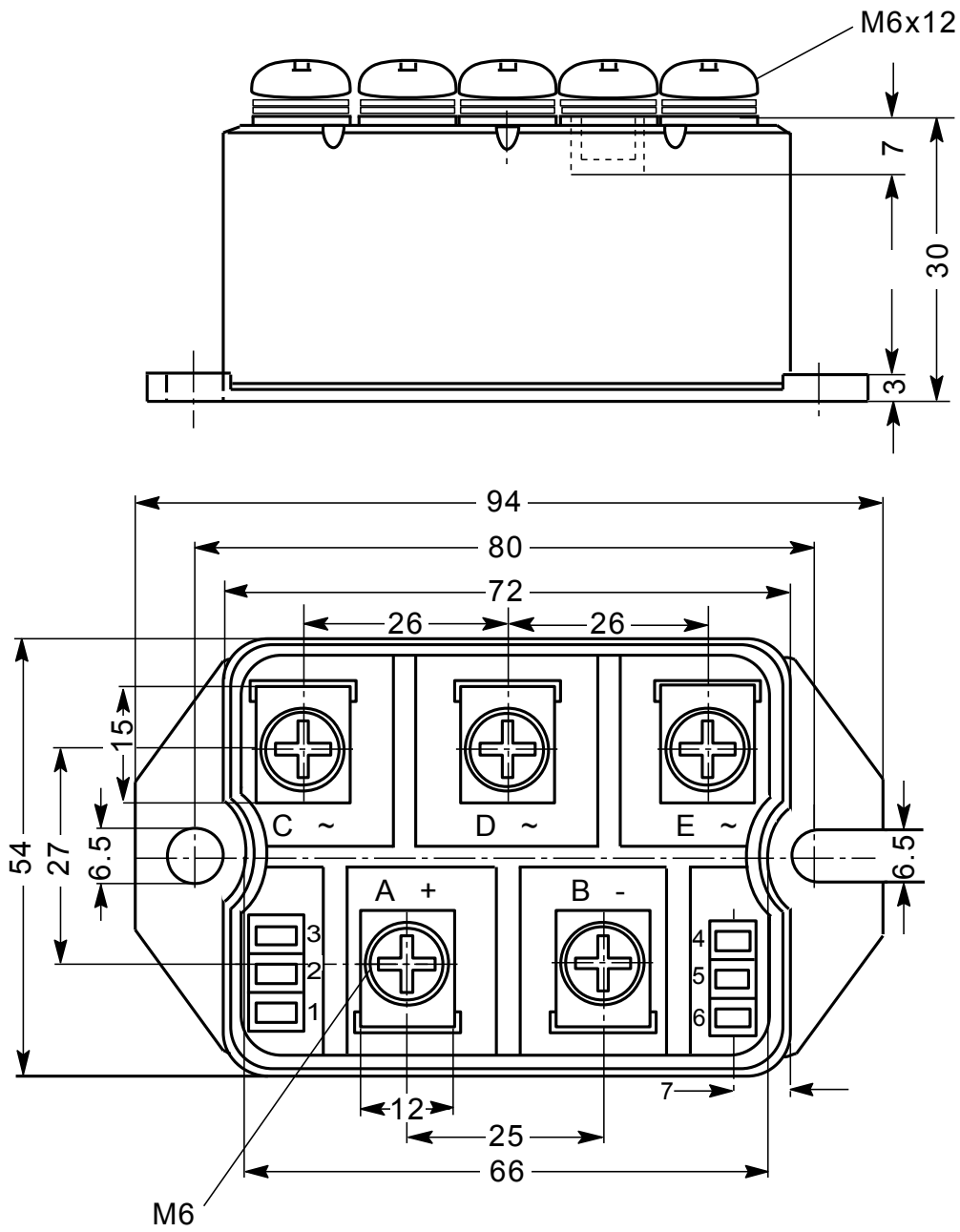

Rectifier

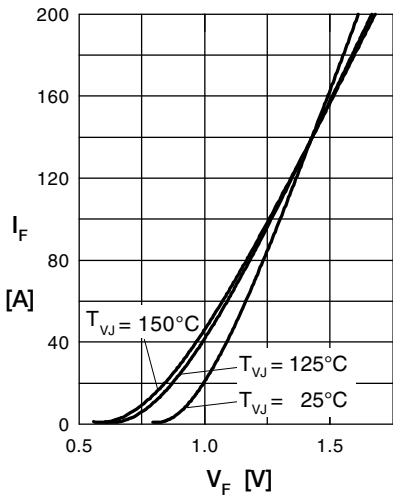

Fig. 1 Forward current vs. voltage drop per diode

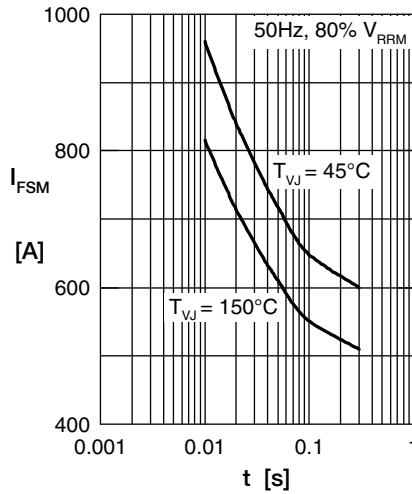

Fig. 2 Surge overload current vs. time per diode

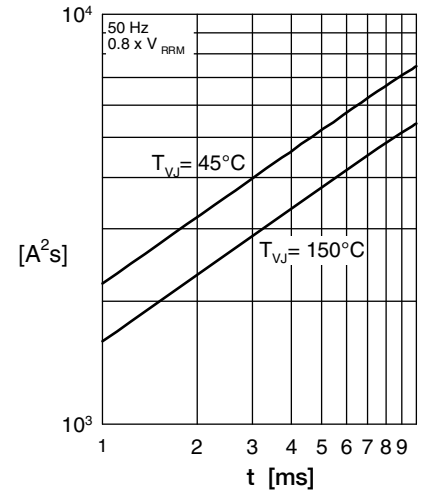

Fig. 3 I^2t vs. time per diode

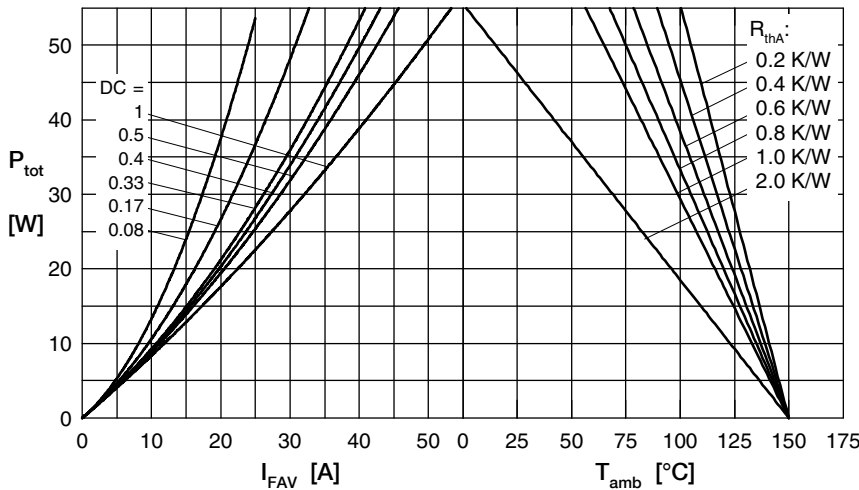

Fig. 4 Power dissipation vs. forward current and ambient temperature per diode

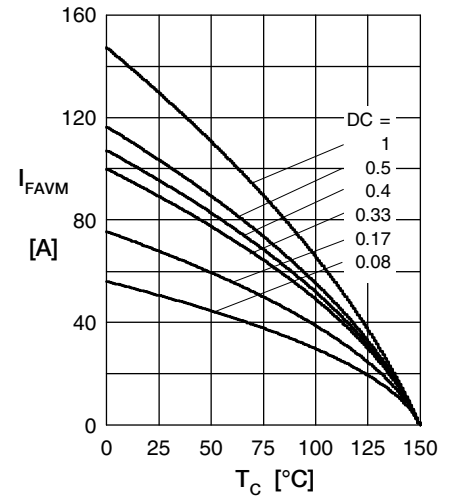

Fig. 5 Max. forward current vs. case temperature per diode

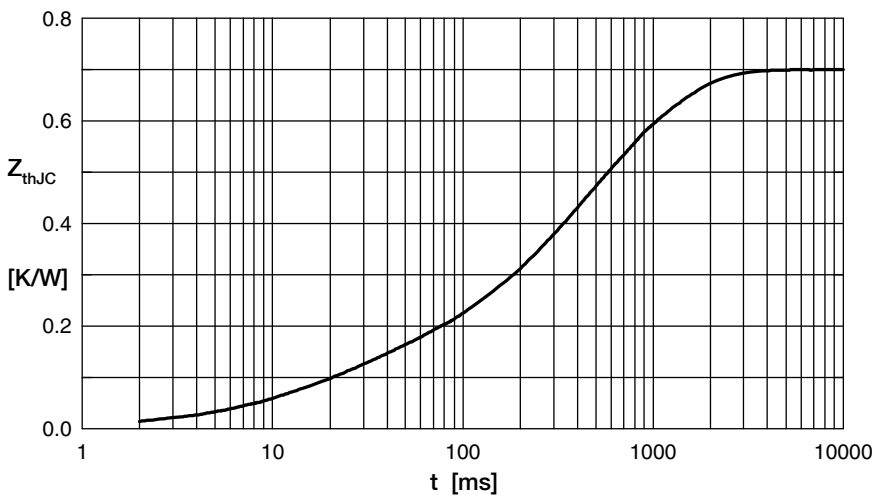

Fig. 6 Transient thermal impedance junction to case vs. time per diode

R_i	t_i
0.100	0.020
0.010	0.010
0.162	0.225
0.258	0.800
0.170	0.580

Mouser Electronics

Authorized Distributor

Click to View Pricing, Inventory, Delivery & Lifecycle Information:

[IXYS:](#)

[VUO110-08NO7](#)