

## Standard Rectifier Module

<b>3~ Rectifier</b>	
$V_{RRM}$	= 1600 V
$I_{DAV}$	= 45 A
$I_{FSM}$	= 300 A

### 3~ Rectifier Bridge

Part number

VUO30-16NO3

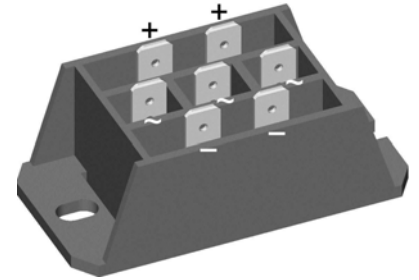

 E72873

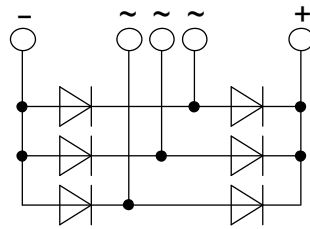

#### Features / Advantages:

- Package with DCB ceramic
- Reduced weight
- Improved temperature and power cycling
- Planar passivated chips
- Very low forward voltage drop
- Very low leakage current

#### Applications:

- Diode for main rectification
- For three phase bridge configurations
- Supplies for DC power equipment
- Input rectifiers for PWM inverter
- Battery DC power supplies
- Field supply for DC motors

#### Package: FO-F-B

- Isolation Voltage: 3600V~
- Industry standard outline
- RoHS compliant
- ¼" fast-on terminals
- Easy to mount with two screws
- Base plate: DCB ceramic
- Reduced weight
- Advanced power cycling

Rectifier				Ratings		
Symbol	Definition	Conditions	min.	typ.	max.	Unit
$V_{RSM}$	max. non-repetitive reverse blocking voltage	$T_{VJ} = 25^{\circ}C$			1700	V
$V_{RRM}$	max. repetitive reverse blocking voltage	$T_{VJ} = 25^{\circ}C$			1600	V
$I_R$	reverse current	$V_R = 1600 V$	$T_{VJ} = 25^{\circ}C$		40	$\mu A$
		$V_R = 1600 V$	$T_{VJ} = 150^{\circ}C$		1.5	mA
$V_F$	forward voltage drop	$I_F = 15 A$	$T_{VJ} = 25^{\circ}C$		1.10	V
		$I_F = 45 A$			1.38	V
		$I_F = 15 A$	$T_{VJ} = 125^{\circ}C$		1.01	V
		$I_F = 45 A$			1.38	V
$I_{DAV}$	bridge output current	$T_C = 110^{\circ}C$ rectangular $d = 1/3$	$T_{VJ} = 150^{\circ}C$		45	A
$V_{FO}$	threshold voltage	} for power loss calculation only	$T_{VJ} = 150^{\circ}C$		0.80	V
$r_F$	slope resistance				12.9	m $\Omega$
$R_{thJC}$	thermal resistance junction to case				2	K/W
$R_{thCH}$	thermal resistance case to heatsink			0.4		K/W
$P_{tot}$	total power dissipation		$T_C = 25^{\circ}C$		60	W
$I_{FSM}$	max. forward surge current	$t = 10 \text{ ms; (50 Hz), sine}$	$T_{VJ} = 45^{\circ}C$		300	A
		$t = 8,3 \text{ ms; (60 Hz), sine}$	$V_R = 0 V$		325	A
		$t = 10 \text{ ms; (50 Hz), sine}$	$T_{VJ} = 150^{\circ}C$		255	A
		$t = 8,3 \text{ ms; (60 Hz), sine}$	$V_R = 0 V$		275	A
$I^2t$	value for fusing	$t = 10 \text{ ms; (50 Hz), sine}$	$T_{VJ} = 45^{\circ}C$		450	A <sup>2</sup> s
		$t = 8,3 \text{ ms; (60 Hz), sine}$	$V_R = 0 V$		440	A <sup>2</sup> s
		$t = 10 \text{ ms; (50 Hz), sine}$	$T_{VJ} = 150^{\circ}C$		325	A <sup>2</sup> s
		$t = 8,3 \text{ ms; (60 Hz), sine}$	$V_R = 0 V$		315	A <sup>2</sup> s
$C_J$	junction capacitance	$V_R = 400 V; f = 1 \text{ MHz}$	$T_{VJ} = 25^{\circ}C$		10	pF

Package FO-F-B		Ratings				
Symbol	Definition	Conditions	min.	typ.	max.	Unit
$I_{RMS}$	RMS current	per terminal			100	A
$T_{stg}$	storage temperature		-40		125	°C
$T_{VJ}$	virtual junction temperature		-40		150	°C
<b>Weight</b>				45		g
$M_D$	mounting torque		2		2.5	Nm
$d_{Spp/App}$	creepage distance on surface   striking distance through air	terminal to terminal	18.0	6.0		mm
$d_{Spb/Apb}$		terminal to backside	26.0	20.0		mm
$V_{ISOL}$	isolation voltage	t = 1 second				V
		t = 1 minute	50/60 Hz, RMS; $I_{ISOL} \leq 1$ mA			V



Ordering	Part Number	Marking on Product	Delivery Mode	Quantity	Code No.
Standard	VUO30-16NO3	VUO30-16NO3	Box	10	426105

### Equivalent Circuits for Simulation

\* on die level

$T_{VJ} = 150^\circ\text{C}$



Rectifier

$V_{0\max}$	threshold voltage	0.8	V
$R_{0\max}$	slope resistance *	11.7	mΩ

Outlines FO-F-B

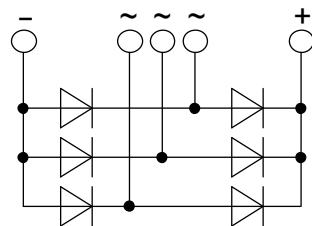
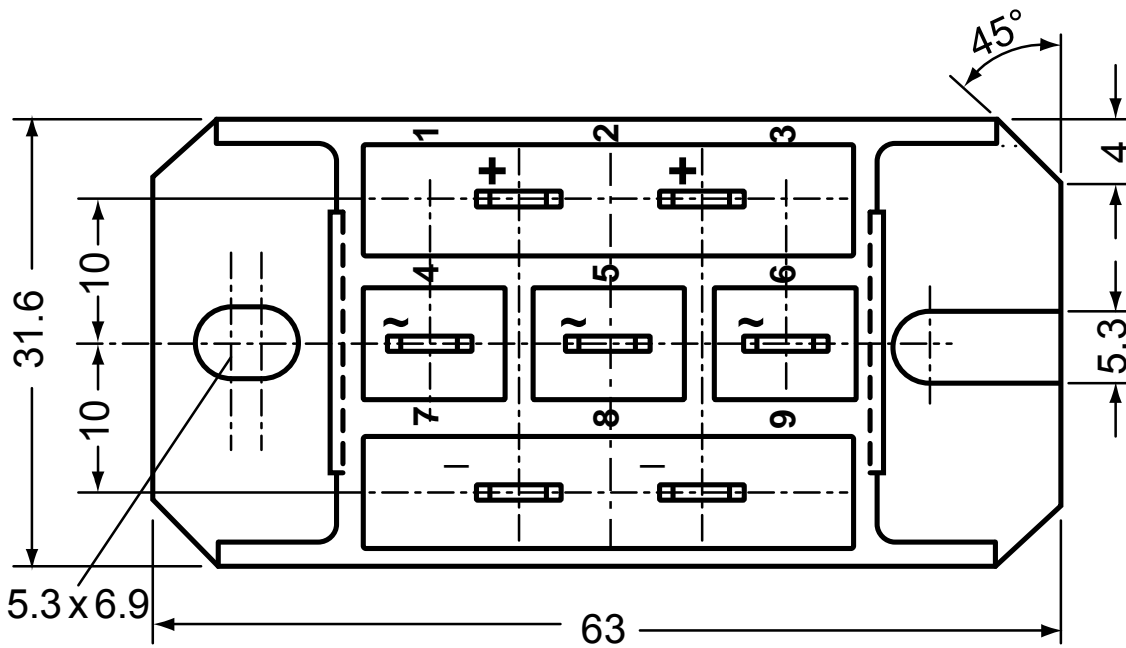
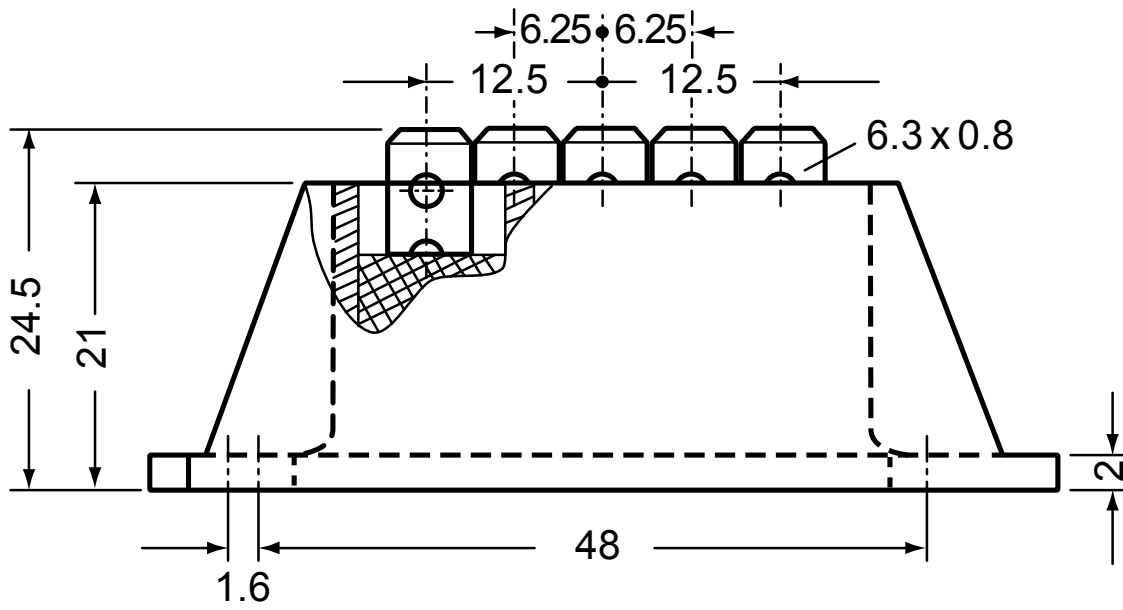

**Rectifier**

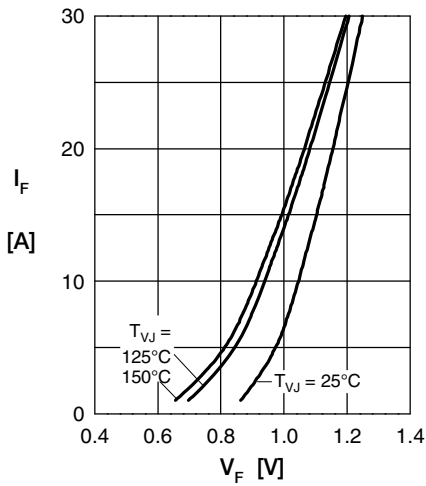

Fig. 1 Forward current vs. voltage drop per diode

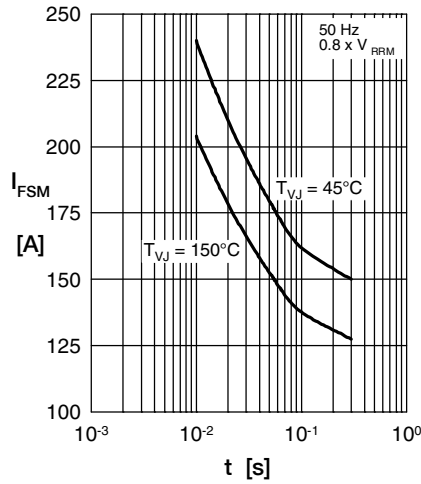

Fig. 2 Surge overload current vs. time per diode

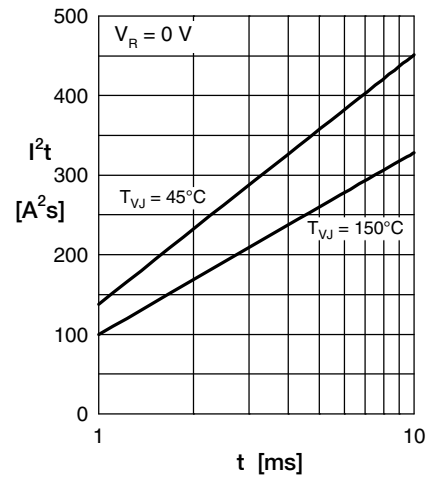

Fig. 3 I<sup>2</sup>t vs. time per diode

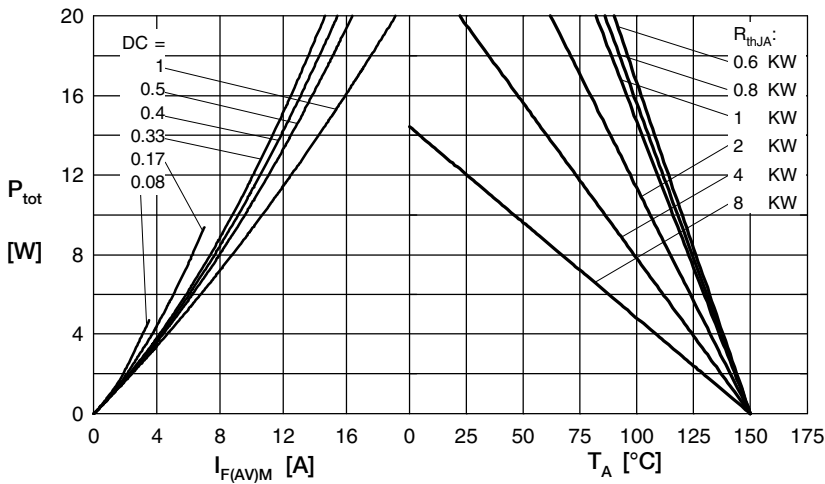

Fig. 4 Power dissipation vs. forward current and ambient temperature per diode

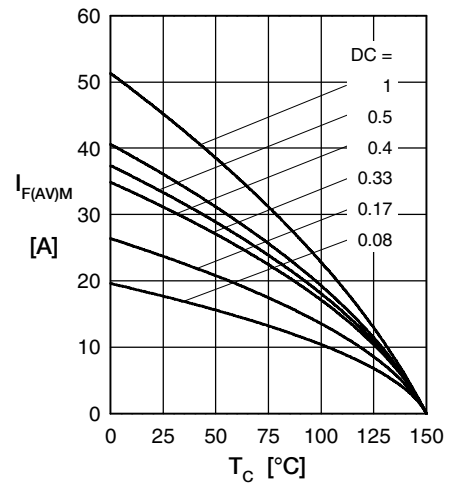

Fig. 5 Max. forward current vs. case temperature per diode

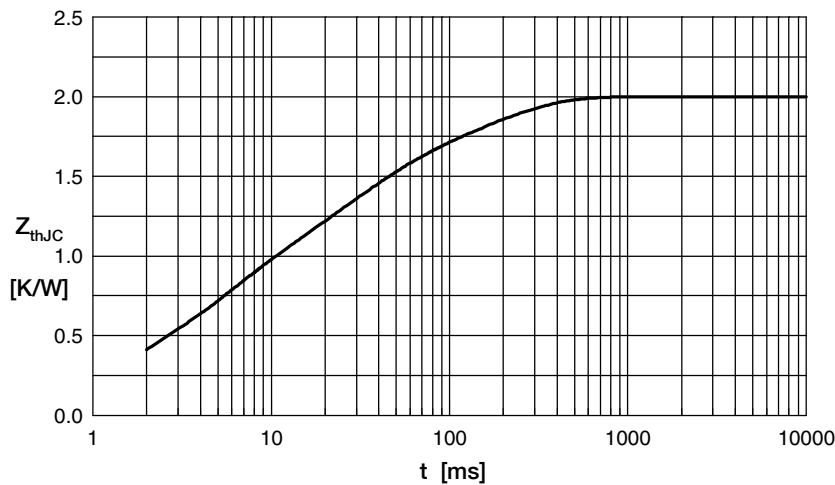

Fig. 6 Transient thermal impedance junction to case vs. time per diode

Constants for  $Z_{thJC}$  calculation:

i	$R_{th}$ (K/W)	$t_i$ (s)
1	0.0607	0.00040
2	0.2030	0.00256
3	0.5005	0.00450
4	0.7030	0.02420
5	0.5328	0.15000

# Mouser Electronics

Authorized Distributor

Click to View Pricing, Inventory, Delivery & Lifecycle Information:

[IXYS:](#)

[VUO30-16NO3](#)