

# High Voltage, High Gain BIMOSFET™ Monolithic Bipolar MOS Transistor

## IXBT12N300 IXBH12N300

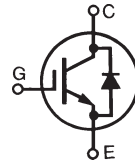

$$V_{CES} = 3000V$$

$$I_{C110} = 12A$$

$$V_{CE(sat)} \leq 3.2V$$

Symbol	Test Conditions	Maximum Ratings	
$V_{CES}$	$T_C = 25^\circ C$ to $150^\circ C$	3000	V
$V_{CGR}$	$T_J = 25^\circ C$ to $150^\circ C$ , $R_{GE} = 1M\Omega$	3000	V
$V_{GES}$	Continuous	$\pm 20$	V
$V_{GEM}$	Transient	$\pm 30$	V
$I_{C25}$	$T_C = 25^\circ C$	30	A
$I_{C110}$	$T_C = 110^\circ C$	12	A
$I_{CM}$	$T_C = 25^\circ C$ , 1ms	100	A
<b>SSOA (RBSOA)</b>	$V_{GE} = 15V$ , $T_{VJ} = 125^\circ C$ , $R_G = 30\Omega$ Clamped Inductive Load	$I_{CM} = 98$ 1500	A V
$P_C$	$T_C = 25^\circ C$	160	W
$T_J$		-55 ... +150	$^\circ C$
$T_{JM}$		150	$^\circ C$
$T_{stg}$		-55 ... +150	$^\circ C$
$T_L$	1.6mm (0.062 in.) from Case for 10s	300	$^\circ C$
$T_{SOLD}$	Plastic Body for 10 seconds	260	$^\circ C$
$M_d$	Mounting Torque (TO-247)	1.13/10	Nm/lb.in.
<b>Weight</b>	TO-268	4	g
	TO-247	6	g

TO-268 (IXBT)

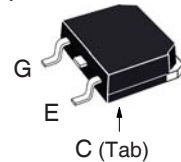

TO-247 (IXBH)

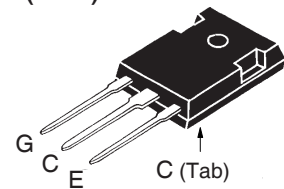

G = Gate      C = Collector  
E = Emitter    Tab = Collector

### Features

- High Blocking Voltage
- International Standard Packages
- Anti-Parallel Diode
- Low Conduction Losses

### Advantages

- Low Gate Drive Requirement
- High Power Density

### Applications:

- Switched-Mode and Resonant-Mode Power Supplies
- Uninterruptible Power Supplies (UPS)
- Laser Generators
- Capacitor Discharge Circuits
- AC Switches

Symbol	Test Conditions	Characteristic Values		
		Min.	Typ.	Max.
$BV_{CES}$	$I_C = 250\mu A$ , $V_{GE} = 0V$	3000		V
$V_{GE(th)}$	$I_C = 250\mu A$ , $V_{CE} = V_{GE}$	3.0		V
$I_{CES}$	$V_{CE} = 0.8 \cdot V_{CES}$ , $V_{GE} = 0V$ $T_J = 125^\circ C$			25 $\mu A$ 1 mA
$I_{GES}$	$V_{CE} = 0V$ , $V_{GE} = \pm 20V$			$\pm 100$ nA
$V_{CE(sat)}$	$I_C = 12A$ , $V_{GE} = 15V$ , Note 1 $T_J = 125^\circ C$		2.8	3.2 V
			3.5	V

### Symbol Test Conditions

( $T_J = 25^\circ\text{C}$  Unless Otherwise Specified)

### Characteristic Values

		Min.	Typ.	Max.	
$g_{fS}$	$I_C = 12\text{A}, V_{CE} = 10\text{V}, \text{Note 1}$	6.5	10.8		S
$C_{ies}$	$V_{CE} = 25\text{V}, V_{GE} = 0\text{V}, f = 1\text{MHz}$		1290		pF
$C_{oes}$			56		pF
$C_{res}$			19		pF
$Q_g$	$I_C = 12\text{A}, V_{GE} = 15\text{V}, V_{CE} = 1000\text{V}$		62		nC
$Q_{ge}$			13		nC
$Q_{gc}$			8.5		nC
$t_{d(on)}$	<b>Resistive Switching Times, <math>T_J = 25^\circ\text{C}</math></b> $I_C = 12\text{A}, V_{GE} = 15\text{V}$ $V_{CE} = 1250\text{V}, R_G = 10\Omega$		64		ns
$t_r$			140		ns
$t_{d(off)}$			180		ns
$t_f$			540		ns
$t_{d(on)}$	<b>Resistive Switching Times, <math>T_J = 125^\circ\text{C}</math></b> $I_C = 12\text{A}, V_{GE} = 15\text{V}$ $V_{CE} = 1250\text{V}, R_G = 10\Omega$		65		ns
$t_r$			395		ns
$t_{d(off)}$			175		ns
$t_f$			530		ns
$R_{thJC}$				0.78	$^\circ\text{C}/\text{W}$
$R_{thCS}$	TO-247		0.21		$^\circ\text{C}/\text{W}$

### Reverse Diode

### Symbol Test Conditions

( $T_J = 25^\circ\text{C}$  Unless Otherwise Specified)

### Characteristic Values

		Min.	Typ.	Max.	
$V_F$	$I_F = 12\text{A}, V_{GE} = 0\text{V}$			2.1	V
$t_{rr}$	$I_F = 6\text{A}, V_{GE} = 0\text{V}, -di_F/dt = 100\text{A}/\mu\text{s}$		1.4		$\mu\text{s}$
$I_{RM}$		$V_R = 100\text{V}, V_{GE} = 0\text{V}$		21	

Note 1: Pulse test,  $t \leq 300\mu\text{s}$ , duty cycle,  $d \leq 2\%$ .

### TO-268 Outline

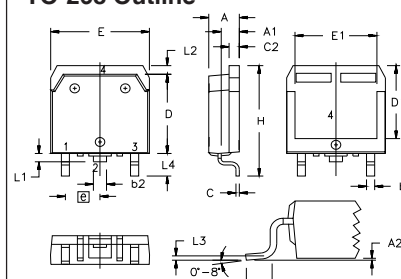

Terminals: 1 - Gate  
3 - Emitter  
2,4 - Collector

SYM	INCHES		MILLIMETERS	
	MIN	MAX	MIN	MAX
A	.193	.201	4.90	5.10
A1	.106	.114	2.70	2.90
A2	.001	.010	0.02	0.25
b	.045	.057	1.15	1.45
b2	.075	.083	1.90	2.10
C	.016	.026	0.40	0.65
C2	.057	.063	1.45	1.60
D	.543	.551	13.80	14.00
D1	.488	.500	12.40	12.70
E	.624	.632	15.85	16.05
E1	.524	.535	13.30	13.60
e	.215 BSC		5.45 BSC	
H	.736	.752	18.70	19.10
L	.094	.106	2.40	2.70
L1	.047	.055	1.20	1.40
L2	.039	.045	1.00	1.15
L3	.010 BSC		0.25 BSC	
L4	.150	.161	3.80	4.10

### TO-247 Outline

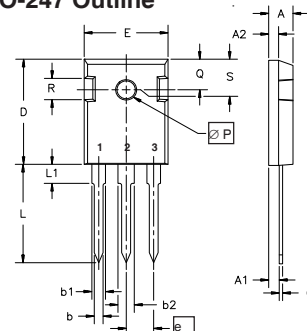

Terminals: 1 - Gate  
3 - Emitter  
2 - Collector

Dim.	Millimeter		Inches	
	Min.	Max.	Min.	Max.
A	4.7	5.3	.185	.209
A <sub>1</sub>	2.2	2.54	.087	.102
A <sub>2</sub>	2.2	2.6	.059	.098
b	1.0	1.4	.040	.055
b <sub>1</sub>	1.65	2.13	.065	.084
b <sub>2</sub>	2.87	3.12	.113	.123
C	.4	.8	.016	.031
D	20.80	21.46	.819	.845
E	15.75	16.26	.610	.640
e	5.20	5.72	0.205	0.225
L	19.81	20.32	.780	.800
L1		4.50		.177
∅P	3.55	3.65	.140	.144
Q	5.89	6.40	0.232	0.252
R	4.32	5.49	.170	.216
S	6.15	BSC	242	BSC

IXYS Reserves the Right to Change Limits, Test Conditions and Dimensions.

IXYS MOSFETs and IGBTs are covered by one or more of the following U.S. patents:

4,835,592	4,931,844	5,049,961	5,237,481	6,162,665	6,404,065 B1	6,683,344	6,727,585	7,005,734 B2	7,157,338B2
4,860,072	5,017,508	5,063,307	5,381,025	6,259,123 B1	6,534,343	6,710,405 B2	6,759,692	7,063,975 B2	
4,881,106	5,034,796	5,187,117	5,486,715	6,306,728 B1	6,583,505	6,710,463	6,771,478 B2	7,071,537	

Fig. 1. Output Characteristics @  $T_J = 25^\circ\text{C}$

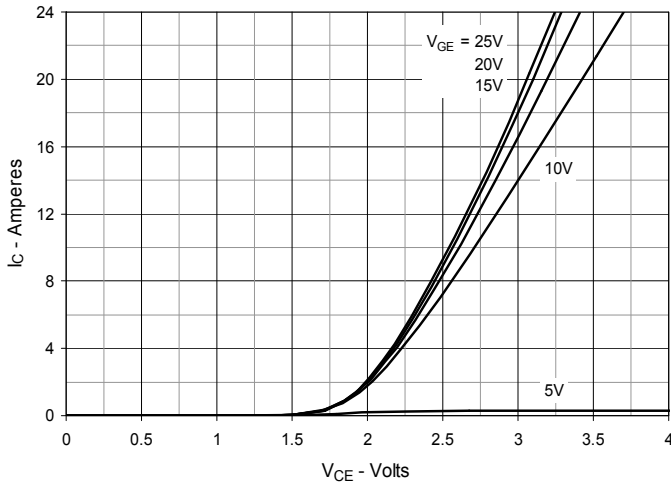

Fig. 2. Extended Output Characteristics @  $T_J = 25^\circ\text{C}$

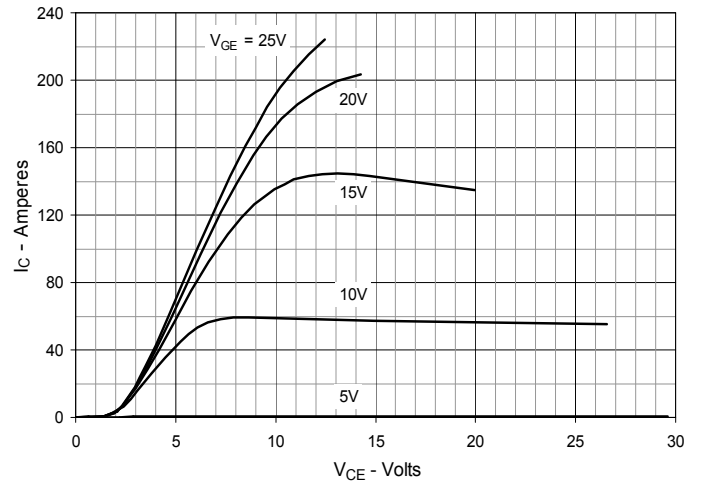

Fig. 3. Output Characteristics @  $T_J = 125^\circ\text{C}$

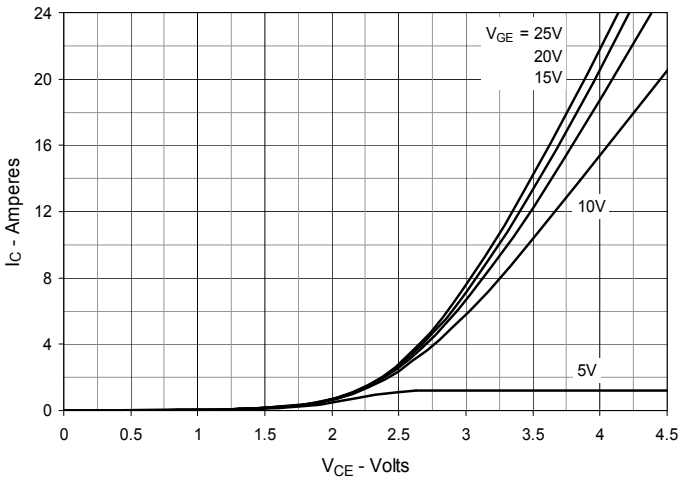

Fig. 4. Dependence of  $V_{CE(sat)}$  on Junction Temperature

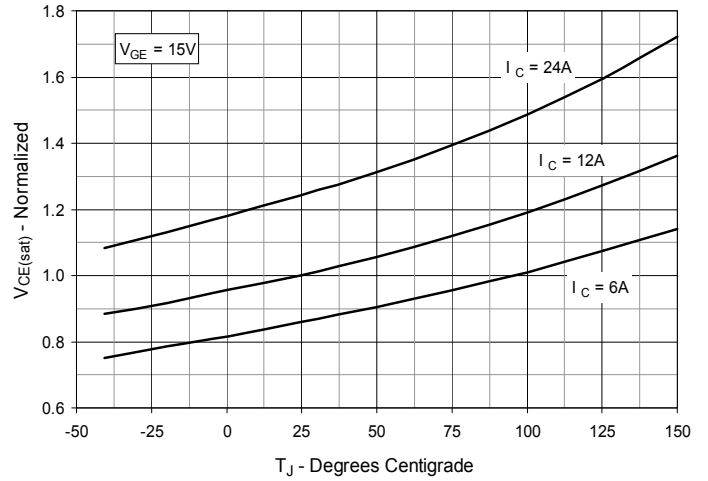

Fig. 5. Collector-to-Emitter Voltage vs. Gate-to-Emitter Voltage

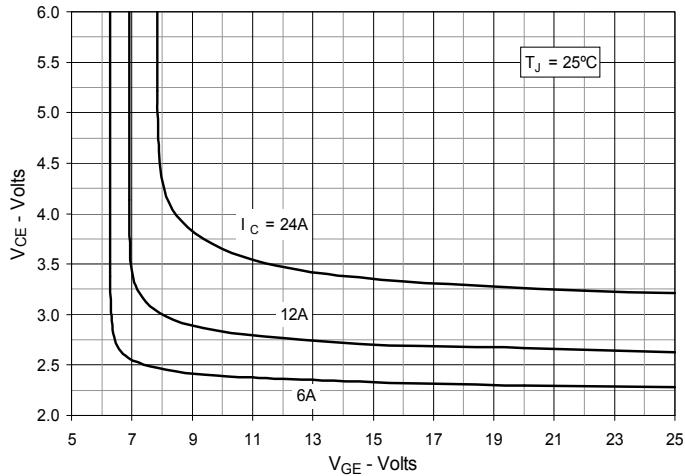

Fig. 6. Input Admittance

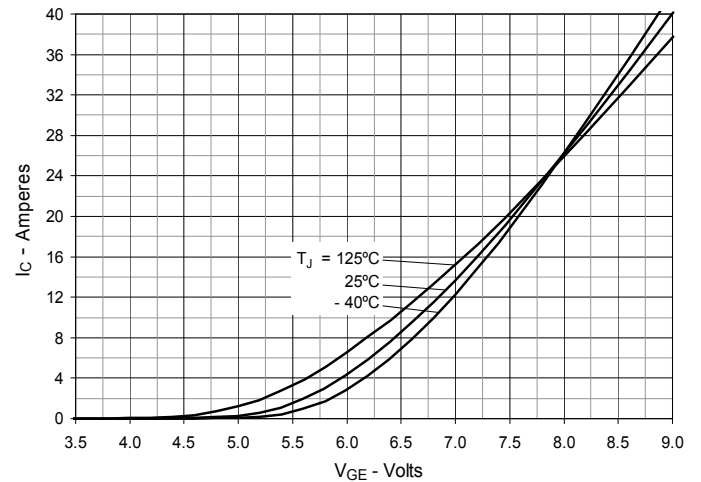

Fig. 7. Transconductance

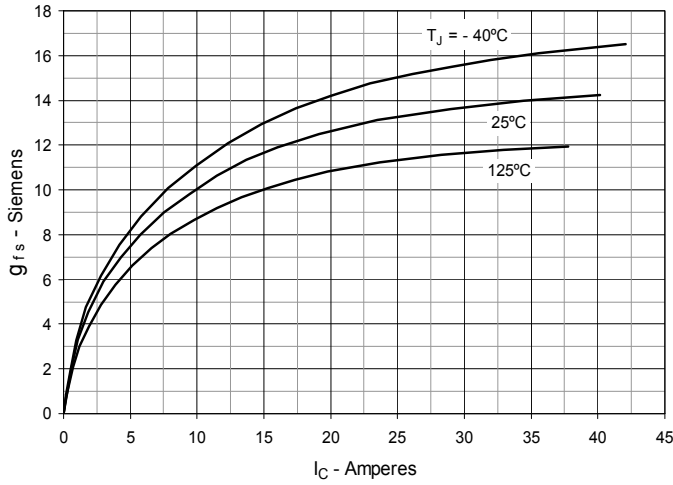

Fig. 8. Forward Voltage Drop of Intrinsic Diode

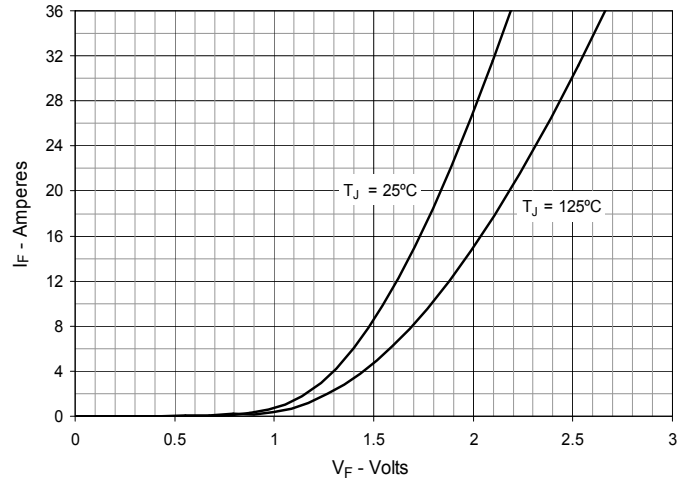

Fig. 9. Gate Charge

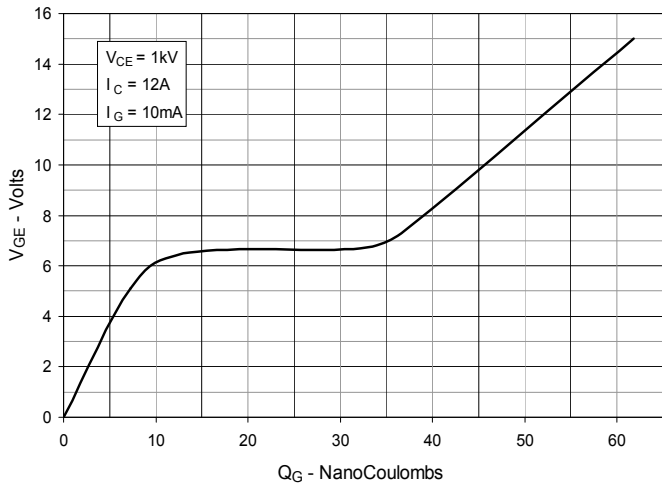

Fig. 10. Capacitance

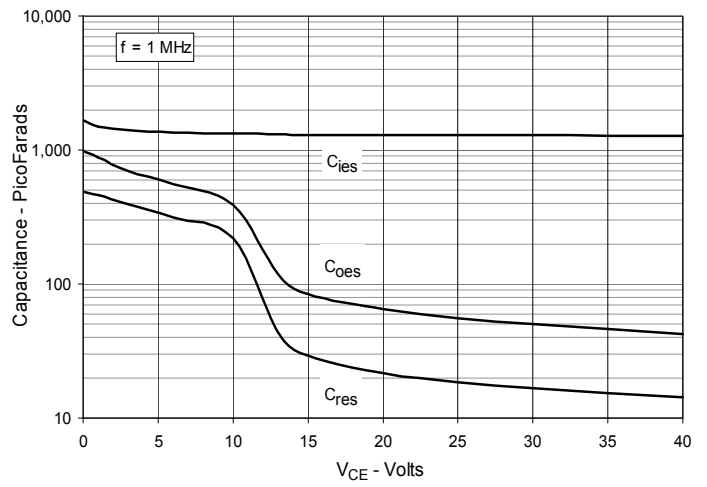

Fig. 11. Reverse-Bias Safe Operating Area

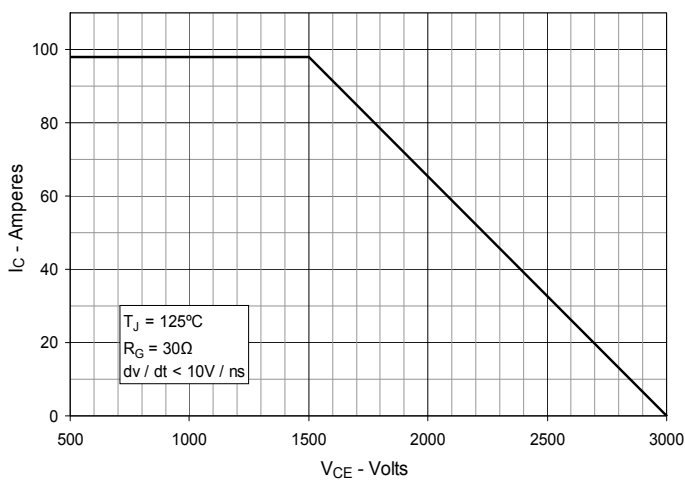
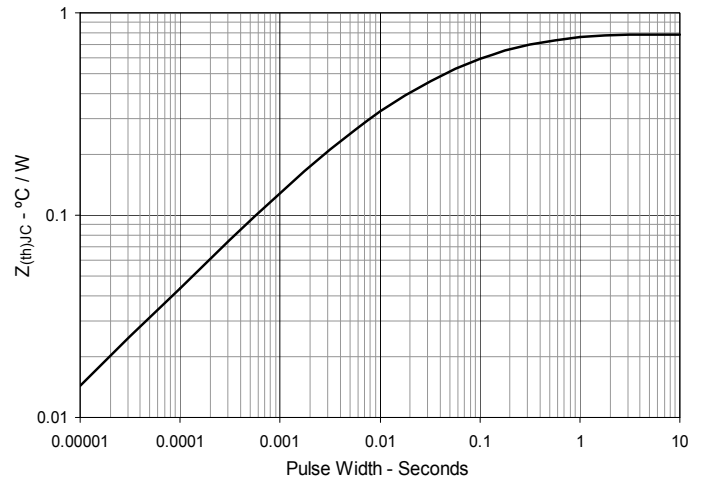
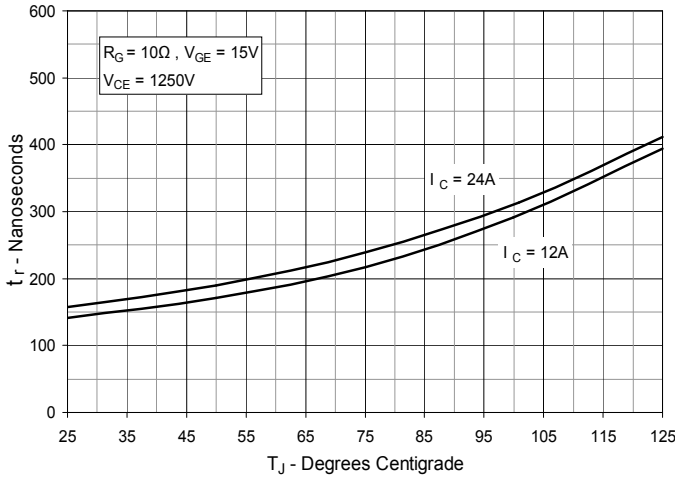

Fig. 12. Maximum Transient Thermal Impedance



**Fig. 13. Resistive Turn-on Rise Time vs. Junction Temperature**



**Fig. 14. Resistive Turn-on Rise Time vs. Collector Current**

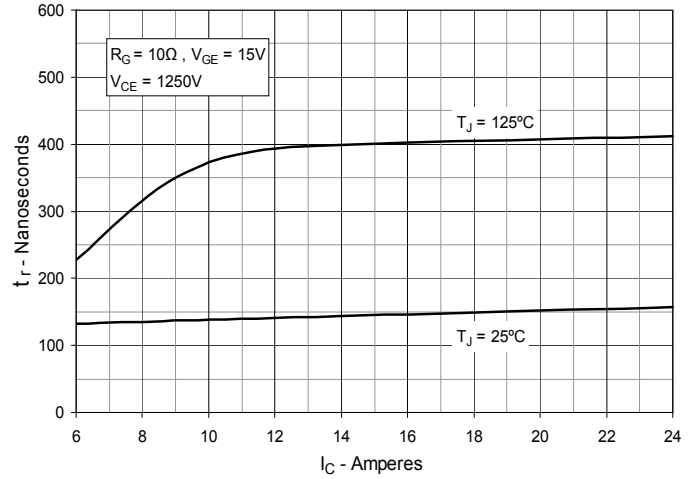

**Fig. 15. Resistive Turn-on Switching Times vs. Gate Resistance**

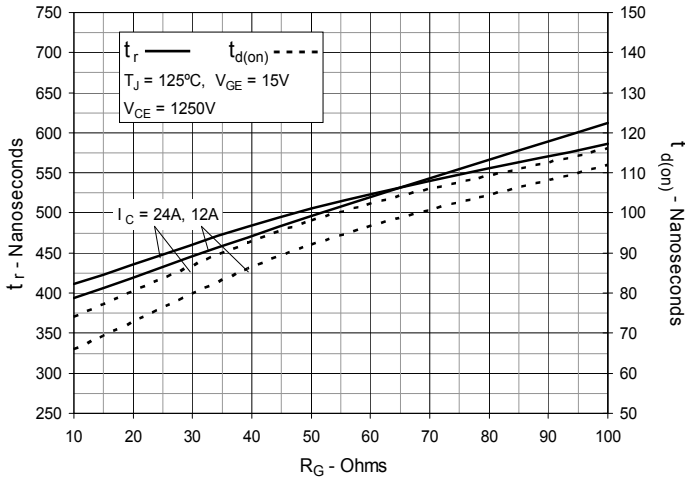

**Fig. 16. Resistive Turn-off Switching Times vs. Junction Temperature**

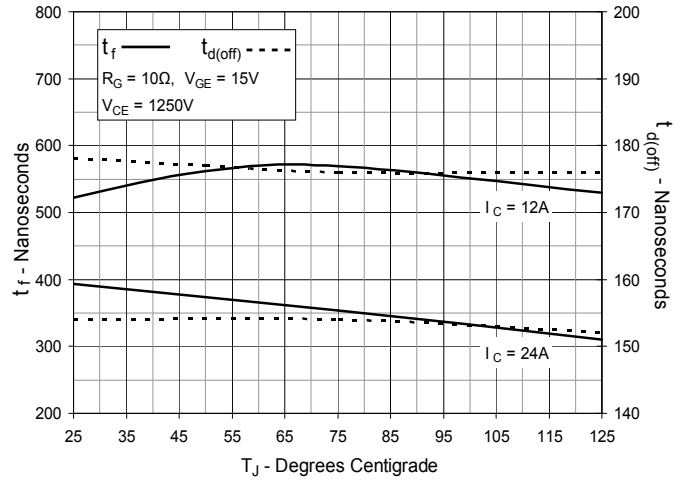

**Fig. 17. Resistive Turn-off Switching Times vs. Collector Current**

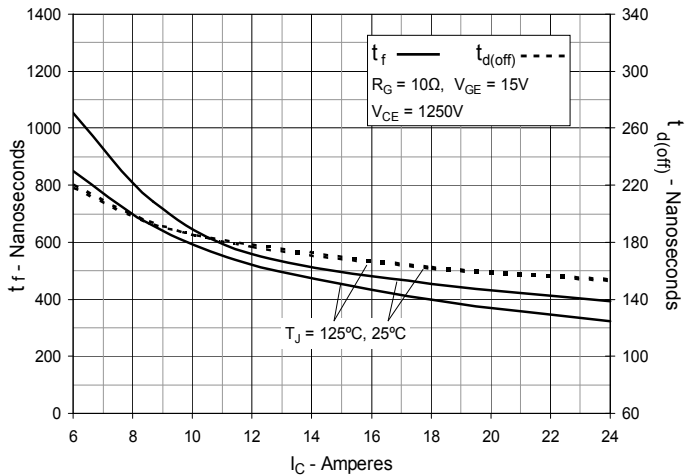

**Fig. 18. Resistive Turn-off Switching Times vs. Gate Resistance**

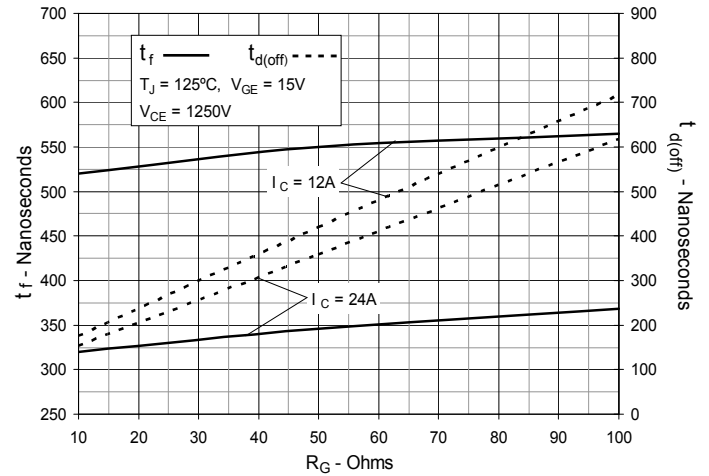

# Mouser Electronics

Authorized Distributor

Click to View Pricing, Inventory, Delivery & Lifecycle Information:

[IXYS:](#)

[IXBH12N300](#)