

XPT™ 600V IGBTs GenX3™ w/ Diode

IXXK100N60B3H1 IXXX100N60B3H1

$V_{CES} = 600V$
 $I_{C100} = 100A$
 $V_{CE(sat)} \leq 1.80V$
 $t_{fi(typ)} = 150ns$

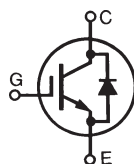

Extreme Light Punch Through IGBT for 10-30kHz Switching

Symbol	Test Conditions	Maximum Ratings	
V_{CES}	$T_J = 25^\circ C$ to $150^\circ C$	600	V
V_{CGR}	$T_J = 25^\circ C$ to $150^\circ C$, $R_{GE} = 1M\Omega$	600	V
V_{GES}	Continuous	± 20	V
V_{GEM}	Transient	± 30	V
I_{C25}	$T_C = 25^\circ C$ (Chip Capability)	200	A
I_{LRMS}	Terminal Current Limit	160	A
I_{C100}	$T_C = 100^\circ C$	100	A
I_{F110}	$T_C = 110^\circ C$	65	A
I_{CM}	$T_C = 25^\circ C$, 1ms	440	A
I_A	$T_C = 25^\circ C$	50	A
E_{AS}	$T_C = 25^\circ C$	600	mJ
SSOA (RBSOA)	$V_{GE} = 15V$, $T_{VJ} = 150^\circ C$, $R_G = 2\Omega$ Clamped Inductive Load	$I_{CM} = 200$ @ $V_{CE} \leq V_{CES}$	A
t_{sc} (SCSOA)	$V_{GE} = 15V$, $V_{CE} = 360V$, $T_J = 150^\circ C$ $R_G = 10\Omega$, Non Repetitive	10	μs
P_C	$T_C = 25^\circ C$	695	W
T_J		-55 ... +150	$^\circ C$
T_{JM}		150	$^\circ C$
T_{stg}		-55 ... +150	$^\circ C$
T_L	Maximum Lead Temperature for Soldering	300	$^\circ C$
T_{SOLD}	1.6 mm (0.062in.) from Case for 10s	260	$^\circ C$
M_d	Mounting Torque (TO-264)	1.13/10	Nm/lb.in.
F_C	Mounting Force (PLUS247)	20..120 /4.5..27	N/lb.
Weight	TO-264	10	g
	PLUS247	6	g

TO-264 (IXXK)

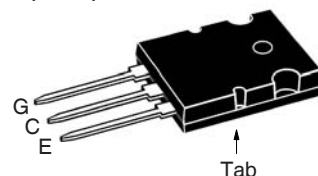

PLUS247 (IXXX)

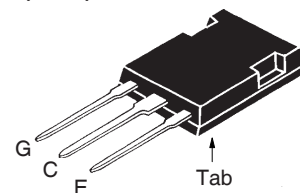

G = Gate E = Emitter
 C = Collector Tab = Collector

Features

- Optimized for 10-30kHz Switching
- Square RBSOA
- Avalanche Rated
- Short Circuit Capability
- Anti-Parallel Ultra Fast Diode
- High Current Handling Capability

Advantages

- High Power Density
- Low Gate Drive Requirement

Applications

- Power Inverters
- UPS
- Motor Drives
- SMPS
- PFC Circuits
- Battery Chargers
- Welding Machines
- Lamp Ballasts

Symbol	Test Conditions ($T_J = 25^\circ C$, Unless Otherwise Specified)	Characteristic Values		
		Min.	Typ.	Max.
BV_{CES}	$I_C = 250\mu A$, $V_{GE} = 0V$	600		V
$V_{GE(th)}$	$I_C = 250\mu A$, $V_{CE} = V_{GE}$	3.0		5.5 V
I_{CES}	$V_{CE} = V_{CES}$, $V_{GE} = 0V$ $T_J = 125^\circ C$			50 μA 4 mA
I_{GES}	$V_{CE} = 0V$, $V_{GE} = \pm 20V$			± 100 nA
$V_{CE(sat)}$	$I_C = 70A$, $V_{GE} = 15V$, Note 1 $T_J = 150^\circ C$	1.50	1.77	V V

Symbol Test Conditions
 $(T_J = 25^\circ\text{C Unless Otherwise Specified})$
Characteristic Values

		Min.	Typ.	Max.	
g_{fs}	$I_C = 60\text{A}, V_{CE} = 10\text{V}, \text{Note 1}$	22	40		S
C_{ies}	$V_{CE} = 25\text{V}, V_{GE} = 0\text{V}, f = 1\text{MHz}$		4860		pF
C_{oes}			475		pF
C_{res}			83		pF
$Q_{g(on)}$	$I_C = 70\text{A}, V_{GE} = 15\text{V}, V_{CE} = 0.5 \cdot V_{CES}$		143		nC
Q_{ge}			37		nC
Q_{gc}			60		nC
$t_{d(on)}$	Inductive load, $T_J = 25^\circ\text{C}$ $I_C = 70\text{A}, V_{GE} = 15\text{V}$ $V_{CE} = 360\text{V}, R_G = 2\Omega$ Note 2		30		ns
t_{ri}			70		ns
E_{on}			1.9		mJ
$t_{d(off)}$			120		ns
t_{fi}			150		ns
E_{off}		2.0	2.8		mJ
$t_{d(on)}$	Inductive load, $T_J = 150^\circ\text{C}$ $I_C = 70\text{A}, V_{GE} = 15\text{V}$ $V_{CE} = 360\text{V}, R_G = 2\Omega$ Note 2		32		ns
t_{ri}			60		ns
E_{on}			2.3		mJ
$t_{d(off)}$			150		ns
t_{fi}			200		ns
E_{off}		2.8		mJ	
R_{thJC}				0.18	$^\circ\text{C/W}$
R_{thCS}		0.15			$^\circ\text{C/W}$

Reverse Diode (FRED)
Symbol Test Conditions
 $(T_J = 25^\circ\text{C Unless Otherwise Specified})$
Characteristic Values

		Min.	Typ.	Max.	
V_F	$I_F = 60\text{A}, V_{GE} = 0\text{V}, \text{Note 1}$		1.6	2.5	V
	$T_J = 150^\circ\text{C}$		1.4	1.8	V
I_{RM}	$I_F = 60\text{A}, V_{GE} = 0\text{V},$ $-di_F/dt = 200\text{A}/\mu\text{s}, V_R = 300\text{V}$		8.3		A
t_{rr}			140		ns
R_{thJC}				0.30	$^\circ\text{C/W}$

Notes:

1. Pulse test, $t \leq 300\mu\text{s}$, duty cycle, $d \leq 2\%$.
2. Switching times & energy losses may increase for higher $V_{CE}(\text{clamp})$, T_J or R_G .

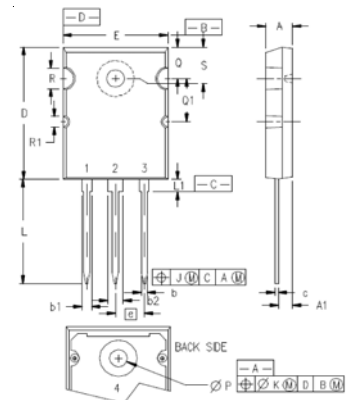
TO-264 Outline

 Terminals: 1 = Gate
2,4 = Collector
3 = Emitter

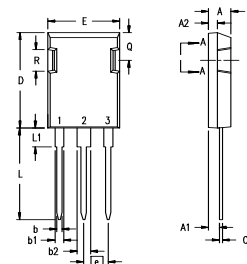
SYM	INCHES		MILLIMETERS	
	MIN	MAX	MIN	MAX
A	.185	.209	4.70	5.31
A1	.102	.118	2.59	3.00
b	.037	.055	0.94	1.40
b1	.087	.102	2.21	2.59
b2	.110	.126	2.79	3.20
c	.017	.029	0.43	0.74
D	1.007	1.047	25.58	26.59
E	.760	.799	19.30	20.29
e	.215 BSC		5.46 BSC	
J	.000	.010	0.00	0.25
K	.000	.010	0.00	0.25
L	.779	.842	19.79	21.39
L1	.087	.102	2.21	2.59
ØP	.122	.138	3.10	3.51
Q	.240	.256	6.10	6.50
Q1	.330	.346	8.38	8.79
ØR	.155	.187	3.94	4.75
ØR1	.085	.093	2.16	2.36
S	.243	.253	6.17	6.43

PLUS247™ Outline

 Terminals: 1 - Gate
2 - Collector
3 - Emitter

Dim.	Millimeter		Inches	
	Min.	Max.	Min.	Max.
A	4.83	5.21	.190	.205
A ₁	2.29	2.54	.090	.100
A ₂	1.91	2.16	.075	.085
b	1.14	1.40	.045	.055
b ₁	1.91	2.13	.075	.084
b ₂	2.92	3.12	.115	.123
C	0.61	0.80	.024	.031
D	20.80	21.34	.819	.840
E	15.75	16.13	.620	.635
e	5.45 BSC		.215 BSC	
L	19.81	20.32	.780	.800
L1	3.81	4.32	.150	.170
Q	5.59	6.20	.220	0.244
R	4.32	4.83	.170	.190

IXYS Reserves the Right to Change Limits, Test Conditions, and Dimensions.

IXYS MOSFETs and IGBTs are covered by one or more of the following U.S. patents:	4,835,592	4,931,844	5,049,961	5,237,481	6,162,665	6,404,065 B1	6,683,344	6,727,585	7,005,734 B2	7,157,338B2
	4,860,072	5,017,508	5,063,307	5,381,025	6,259,123 B1	6,534,343	6,710,405 B2	6,759,692	7,063,975 B2	
	4,881,106	5,034,796	5,187,117	5,486,715	6,306,728 B1	6,583,505	6,710,463	6,771,478 B2	7,071,537	

Fig. 1. Output Characteristics @ $T_J = 25^\circ\text{C}$

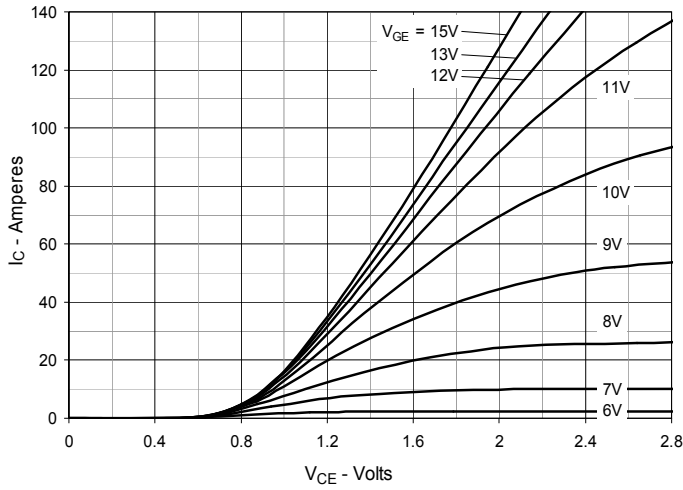

Fig. 2. Extended Output Characteristics @ $T_J = 25^\circ\text{C}$

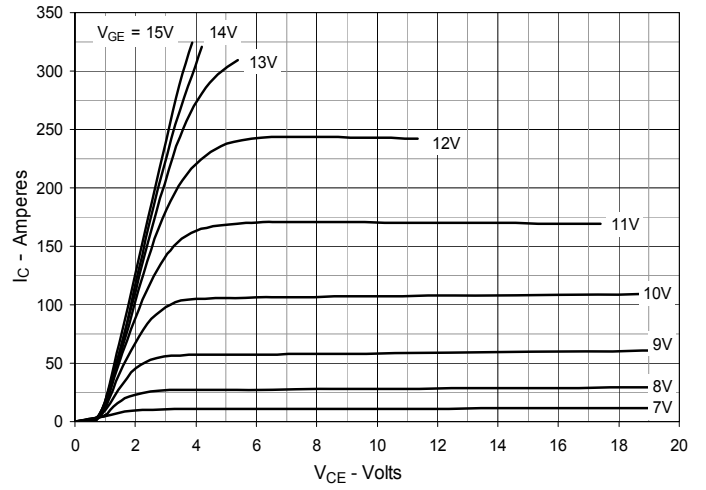

Fig. 3. Output Characteristics @ $T_J = 150^\circ\text{C}$

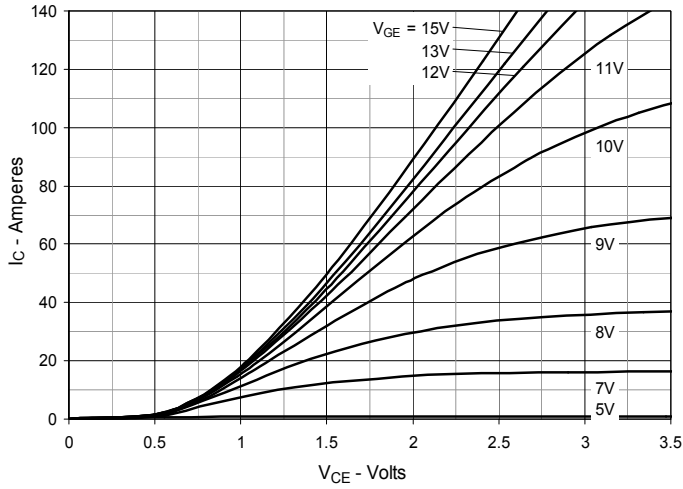

Fig. 4. Dependence of $V_{CE(sat)}$ on Junction Temperature

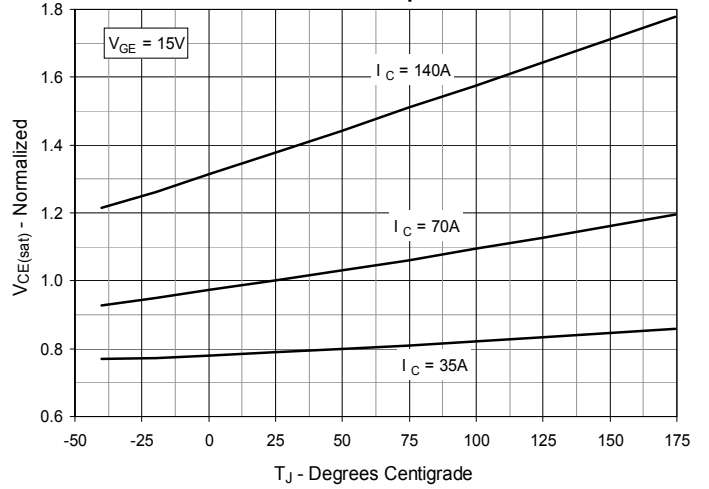

Fig. 5. Collector-to-Emitter Voltage vs. Gate-to-Emitter Voltage

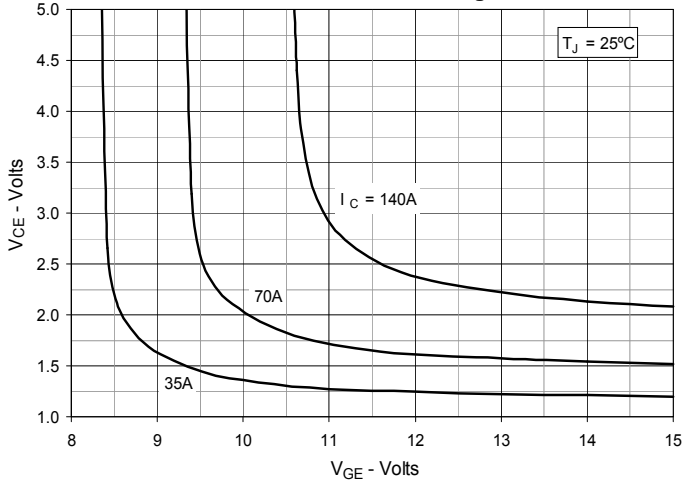

Fig. 6. Input Admittance

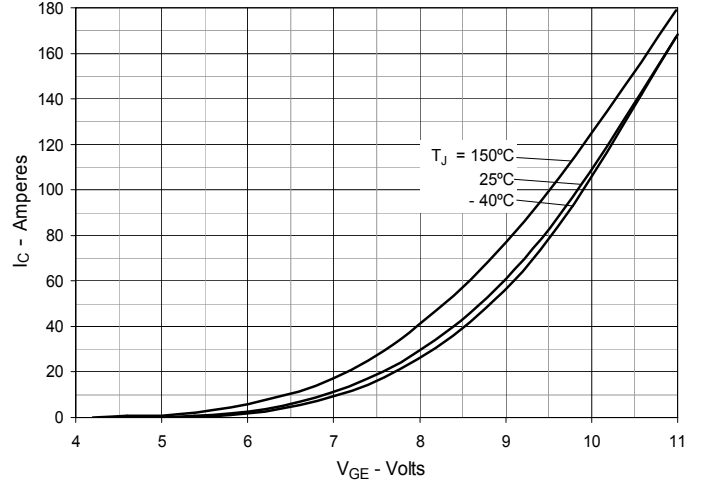

Fig. 7. Transconductance

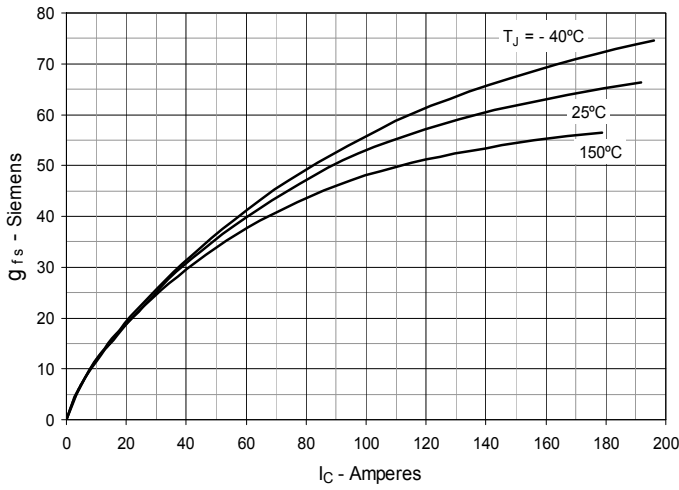

Fig. 8. Gate Charge

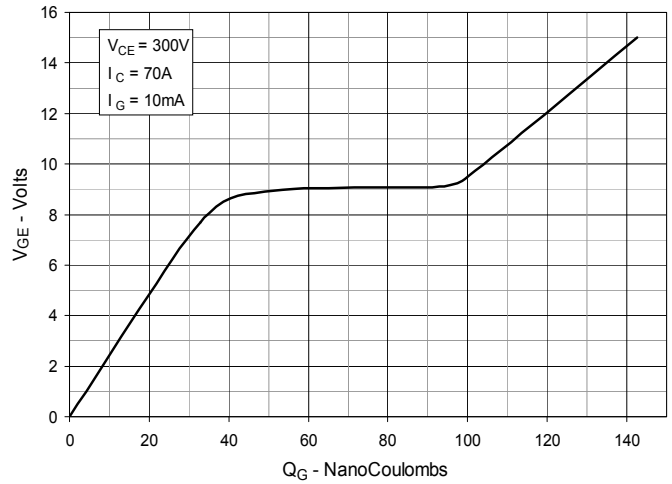

Fig. 9. Capacitance

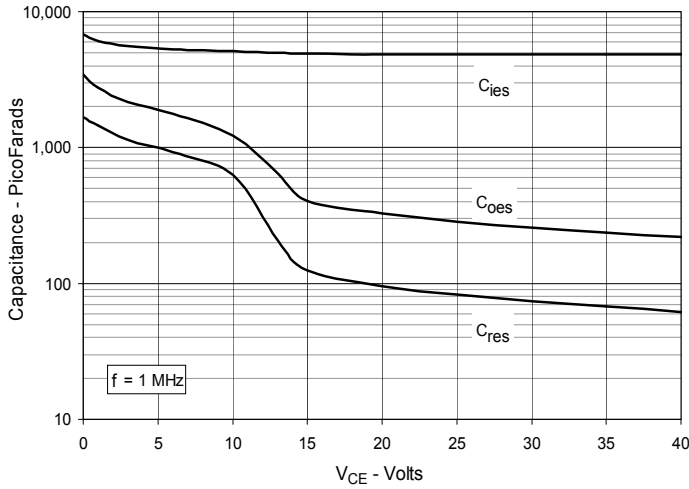

Fig. 10. Reverse-Bias Safe Operating Area

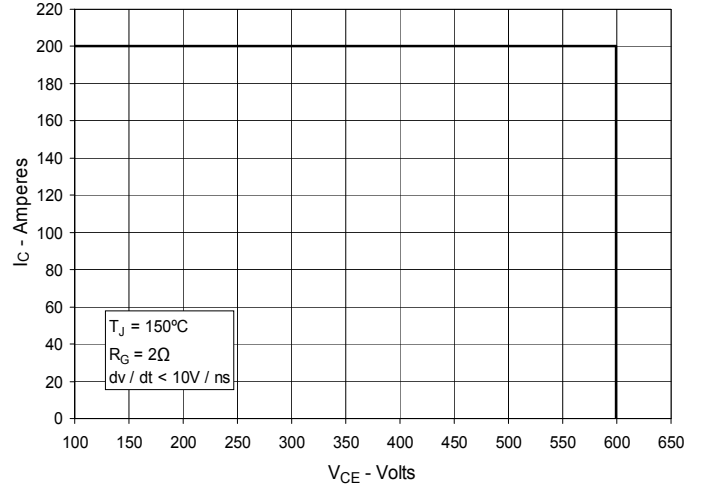

Fig. 11. Forward-Bias Safe Operating Area

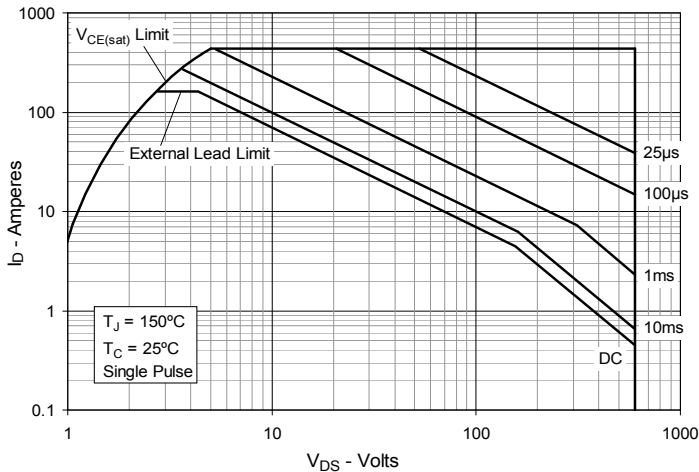

Fig. 12. Maximum Transient Thermal Impedance

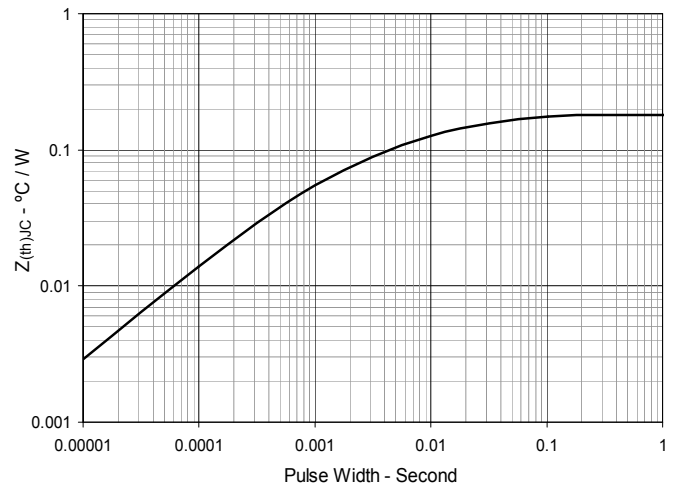

Fig. 13. Inductive Switching Energy Loss vs. Gate Resistance

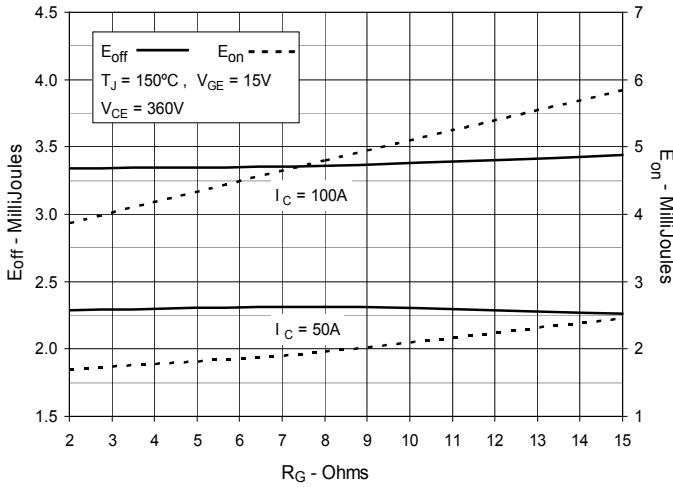

Fig. 14. Inductive Switching Energy Loss vs. Collector Current



Fig. 15. Inductive Switching Energy Loss vs. Junction Temperature

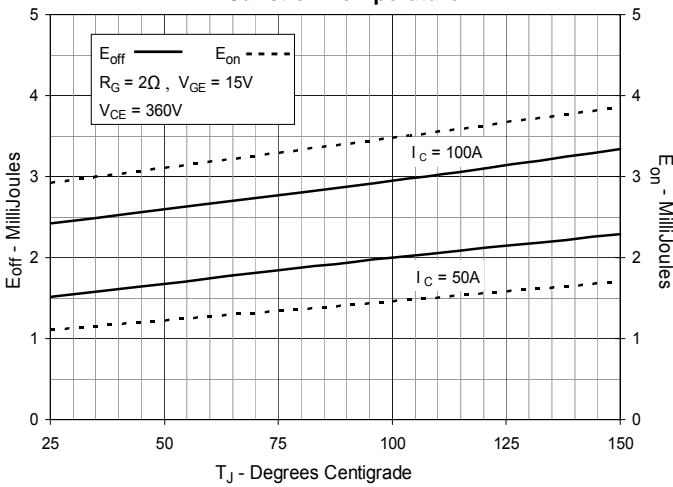

Fig. 16. Inductive Turn-off Switching Times vs. Gate Resistance

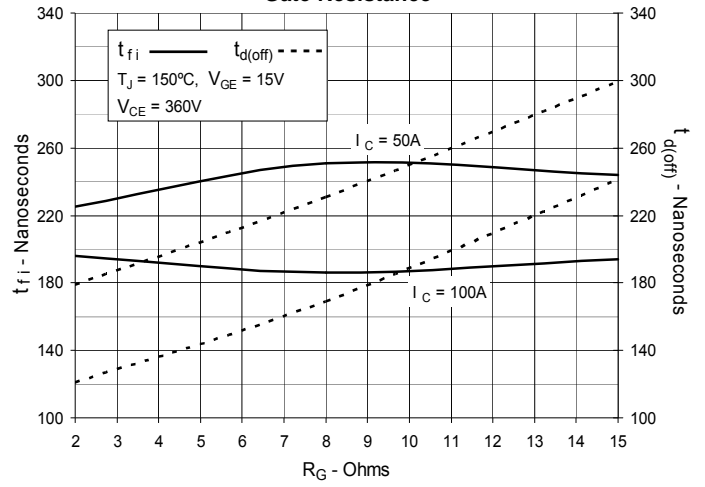

Fig. 17. Inductive Turn-off Switching Times vs. Collector Current

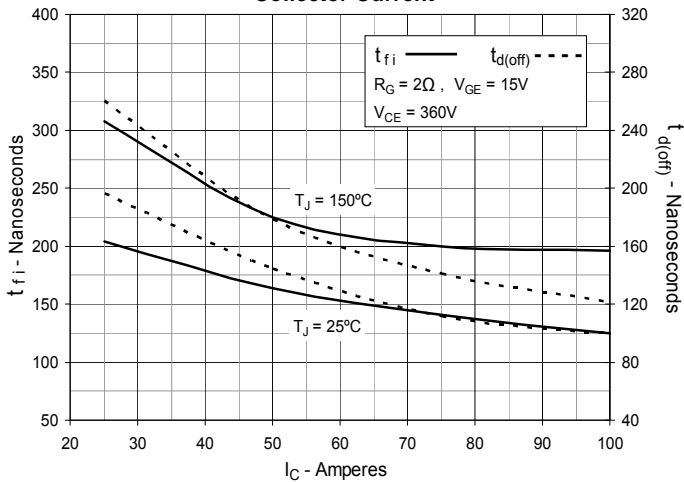

Fig. 18. Inductive Turn-off Switching Times vs. Junction Temperature

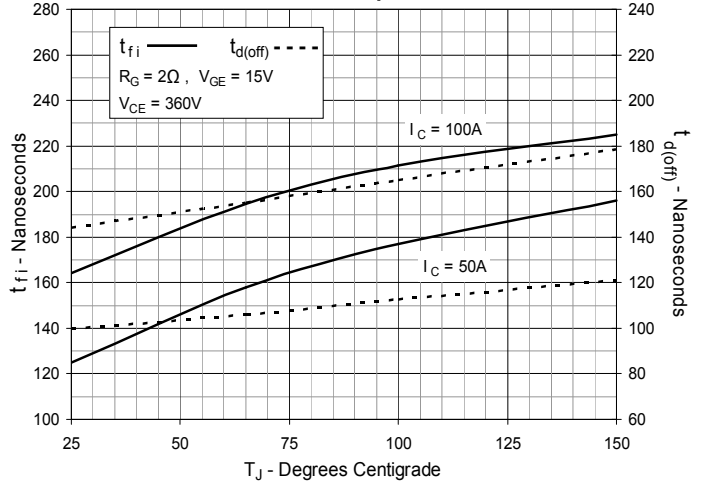

Fig. 19. Inductive Turn-on Switching Times vs. Gate Resistance

Fig. 20. Inductive Turn-on Switching Times vs. Collector Current

Fig. 21. Inductive Turn-on Switching Times vs. Junction Temperature



Fig. 22. Forward Current I_F Versus V_F

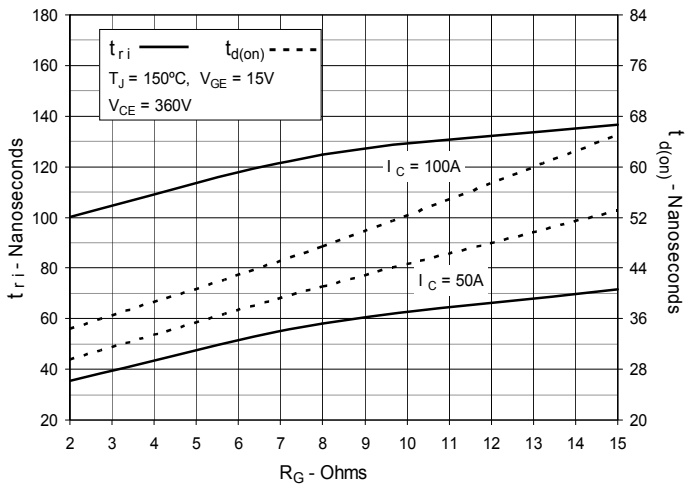
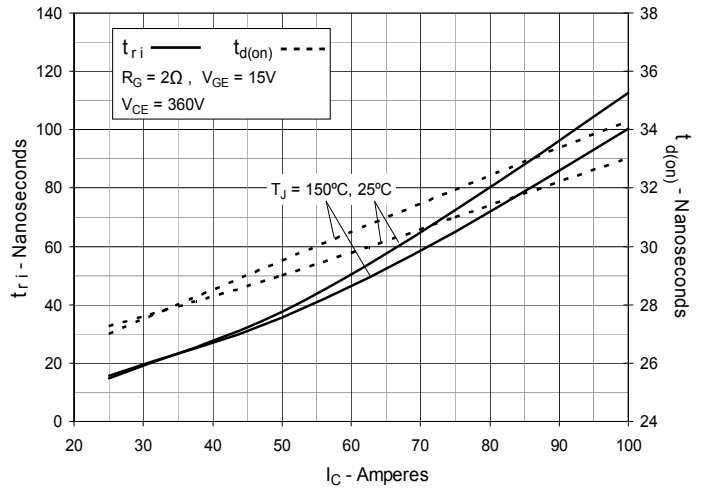
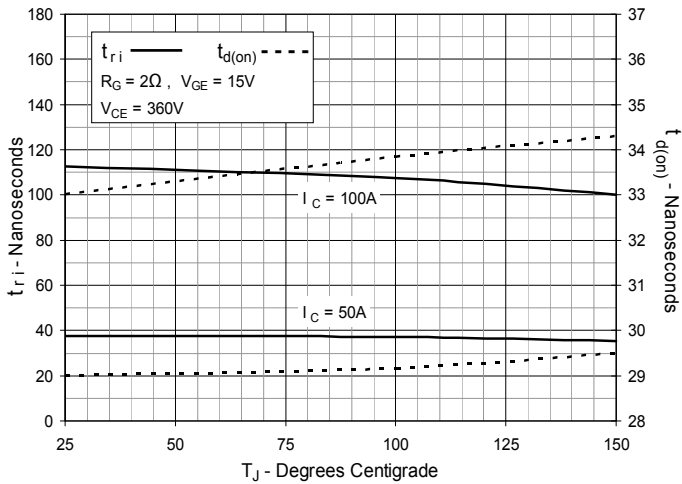

Fig. 23. Reverse Recovery Charge Q_{rr} Versus $-di_F/dt$

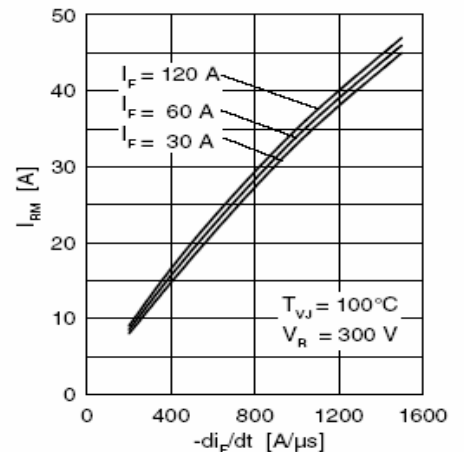

Fig. 24. Peak Reverse Current I_{RM} Versus $-di_F/dt$

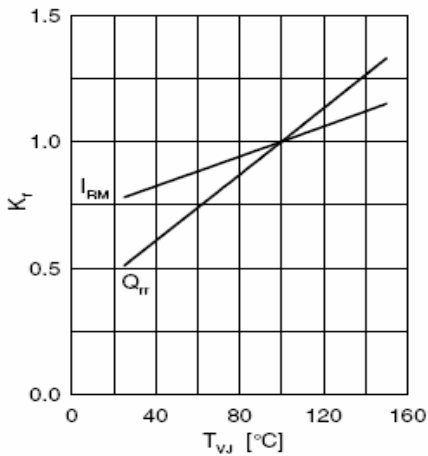

Fig. 25. Dynamic Parameters Q_{rr} , I_{RM} Versus T_{VJ}

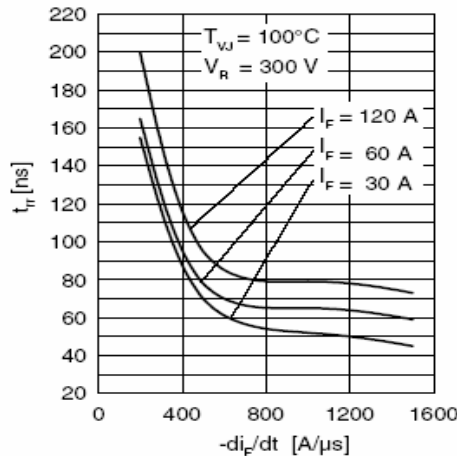

Fig. 26. Recovery Time t_{rr} Versus $-di_F/dt$

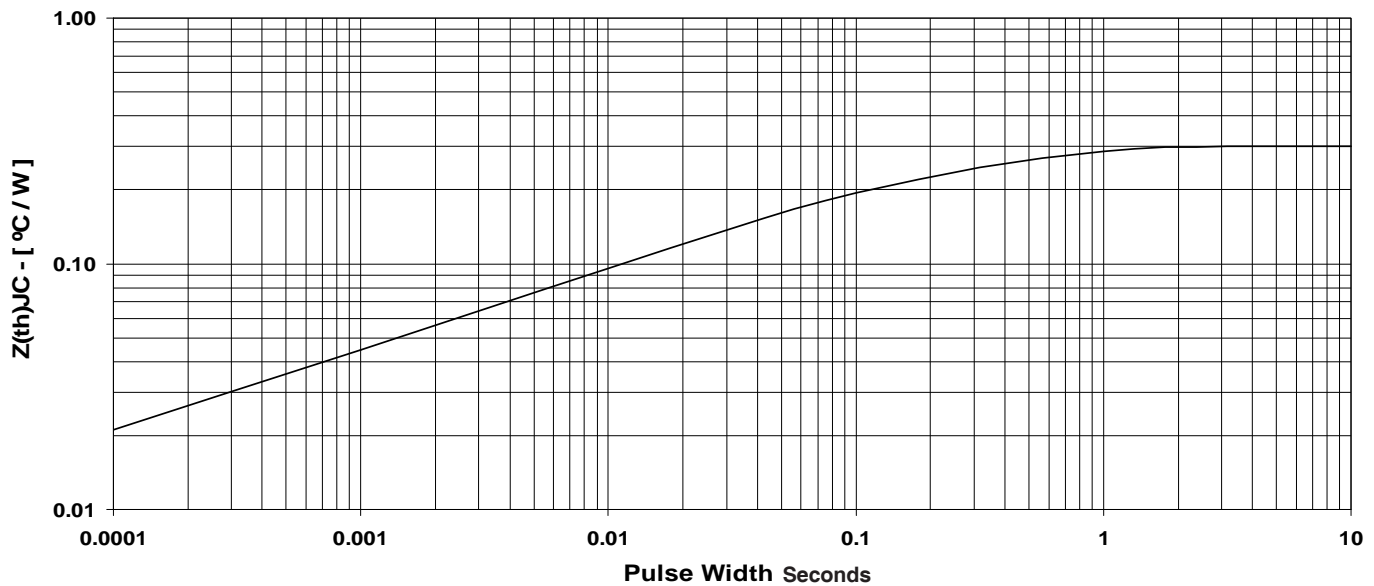

Fig. 27. Maximum transient thermal impedance junction to case (for diode)

Mouser Electronics

Authorized Distributor

Click to View Pricing, Inventory, Delivery & Lifecycle Information:

[IXYS:](#)

[IXXX100N60B3H1](#)