

Single Phase Rectifier Bridge with Fast Recovery Epitaxial Diodes (FRED) in ECO-PAC 2

$I_{dAV} = 100 \text{ A}$
 $V_{RRM} = 600 \text{ V}$
 $t_{rr} = 35 \text{ ns}$

Preliminary data sheet

V_{RSM} V	V_{RRM} V	Typ
600	600	VBE 100-06NO7

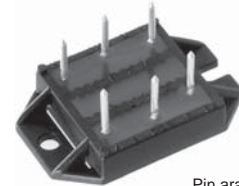
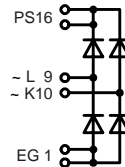

Pin arrangement see outlines

Symbol	Conditions	Maximum Ratings	
$I_{dAV}^{①}$	$T_C = 85^\circ\text{C}$, module	100	A
I_{dAVM}		100	A
I_{FSM}	$T_{VJ} = 45^\circ\text{C}$ $V_R = 0$	$t = 10 \text{ ms}$ (50 Hz), sine	600 A
		$t = 8.3 \text{ ms}$ (60 Hz), sine	640 A
	$T_{VJ} = T_{VJM}$ $V_R = 0$	$t = 10 \text{ ms}$ (50 Hz), sine	520 A
		$t = 8.3 \text{ ms}$ (60 Hz), sine	555 A
I^2t	$T_{VJ} = 45^\circ\text{C}$ $V_R = 0$	$t = 10 \text{ ms}$ (50 Hz), sine	1800 A ² s
		$t = 8.3 \text{ ms}$ (60 Hz), sine	1720 A ² s
	$T_{VJ} = T_{VJM}$ $V_R = 0$	$t = 10 \text{ ms}$ (50 Hz), sine	1350 A ² s
		$t = 8.3 \text{ ms}$ (60 Hz), sine	1295 A ² s
T_{VJ}		-40...+150	°C
T_{VJM}		150	°C
T_{stg}		-40...+125	°C
V_{ISOL}	50/60 Hz, RMS	$t = 1 \text{ min}$	3000 V~
	$I_{ISOL} \leq 1 \text{ mA}$	$t = 1 \text{ s}$	3600 V~
M_d Weight	Mounting torque (M4)	1.5-2/14-18	Nm/lb.in.
	typ.	24	g

Features

- Package with DCB ceramic base plate in low profile
- Isolation voltage 3000 V~
- Planar passivated chips
- Low forward voltage drop
- Leads suitable for PC board soldering

Applications

- Supplies for DC power equipment
- Input and output rectifiers for high frequency
- Battery DC power supplies
- Field supply for DC motors

Advantages

- Space and weight savings
- Improved temperature and power cycling capability
- Small and light weight
- Low noise switching

Symbol	Conditions	Characteristic Values	
		typ.	max.
I_R	$V_R = V_{RRM}$	$T_{VJ} = 25^\circ\text{C}$	0.1 mA
	$V_R = V_{RRM}$	$T_{VJ} = T_{VJM}$	2.5 mA
V_F	$I_F = 60 \text{ A}$	$T_{VJ} = 25^\circ\text{C}$	2.04 V
V_{T0}	for power-loss calculations only		1.09 V
r_T			4.3 mΩ
R_{thJC}	per diode; DC current		0.8 K/W
R_{thCH}	per diode; DC current, typ.		0.2 K/W
I_{RM}	$I_F = 130 \text{ A}$, $-di/dt = 100 \text{ A}/\mu\text{s}$		6.8 A
	$V_R = 100 \text{ V}$, $T_{VJ} = 100^\circ\text{C}$		
t_{rr}	$I_F = 1 \text{ A}$; $-di/dt = 300 \text{ A}/\mu\text{s}$; $V_R = 30 \text{ V}$, $T_{VJ} = 25^\circ\text{C}$	35	ns
a	Max. allowable acceleration	50	m/s ²
d_s	creeping distance on surface (pin to heatsink)	11.2	mm
d_A	strike distance in air (pin to heatsink)	9.7	mm

Data according to IEC 60747 refer to a single diode unless otherwise stated

① for resistive load at bridge output.

IXYS reserves the right to change limits, test conditions and dimensions.

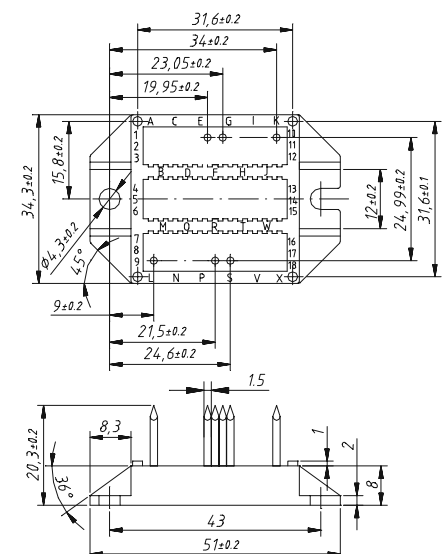
Dimensions in mm (1 mm = 0.0394")

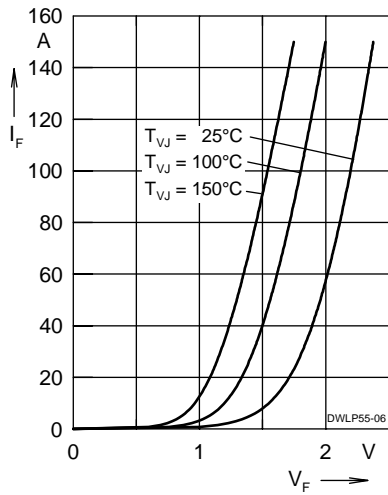

Fig. 1 Forward current I_F versus V_F

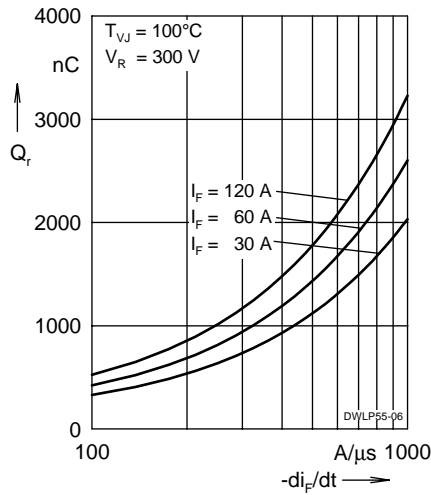

Fig. 2 Reverse recovery charge Q_r versus $-di_F/dt$

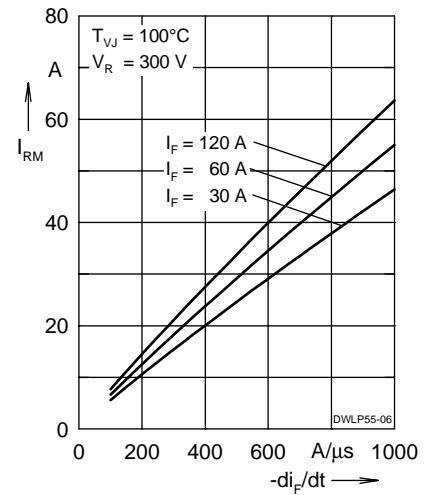

Fig. 3 Peak reverse current I_{RM} versus $-di_F/dt$

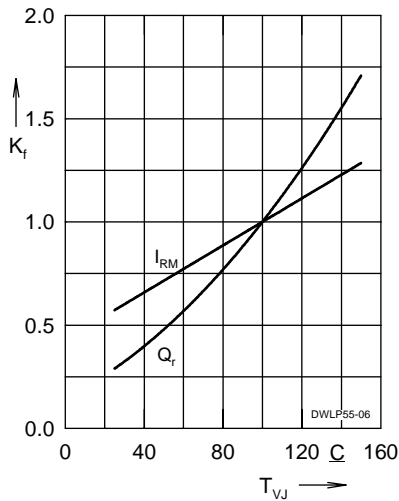

Fig. 4 Dynamic parameters Q_r , I_{RM} versus T_{VJ}

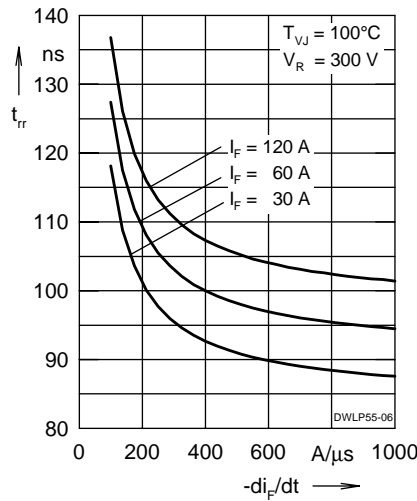

Fig. 5 Recovery time t_{rr} versus $-di_F/dt$

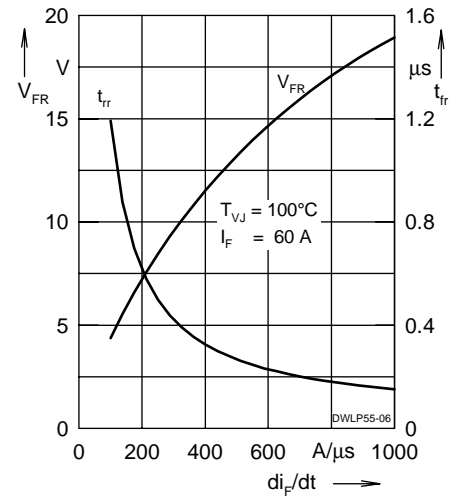

Fig. 6 Peak forward voltage V_{FR} and t_{tr} versus di_F/dt

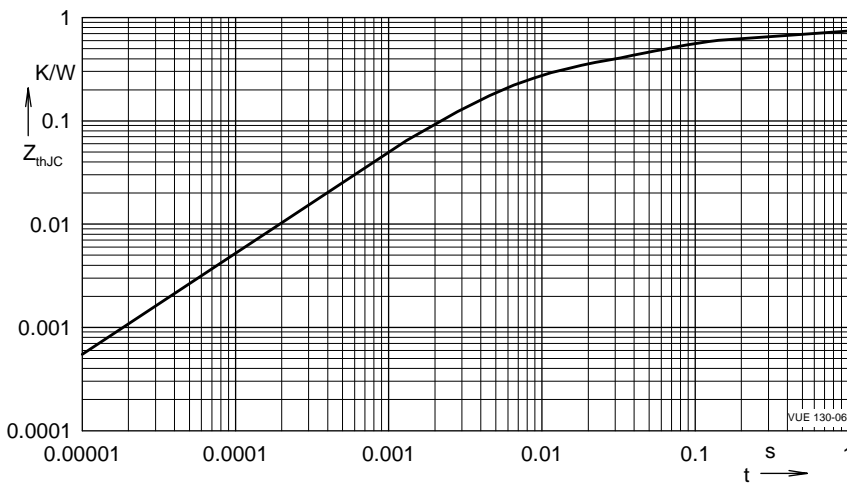

Fig. 7 Typical transient thermal resistance junction to case

NOTE: Fig. 2 to Fig. 6 shows typical values

IXYS reserves the right to change limits, test conditions and dimensions.

Mouser Electronics

Authorized Distributor

Click to View Pricing, Inventory, Delivery & Lifecycle Information:

[IXYS:](#)

[VBE100-06NO7](#)