



LITEON | LITE-ON TECHNOLOGY CORPORATION

Property of LITE-ON Only

FEATURES

Dec.2008

- * Current transfer ratio
(CTR : MIN. 50% at $I_F = 5\text{mA}$, $V_{CE} = 5\text{V}$)

- * Isolation voltage between input and output
($V_{iso} = 3\text{KV}_{rms}$)

- * Compact dual-in-line package
LTV-217: 1 channel type
LTV-227: 2 channels type
LTV-247: 4 channels type

- * Employs double transfer mold technology

- * Safety approved
FIMKO \ VDE approved
UL \ CUL under construction until Mar 2009.

- * ROHS compliance

Application

1. Computer terminals
2. System appliances, measurements.
3. Programmable logic controller
4. Signal transmission between circuits of different potentials and impedances.

OUTLINE DIMENSIONS

LTV-217 :

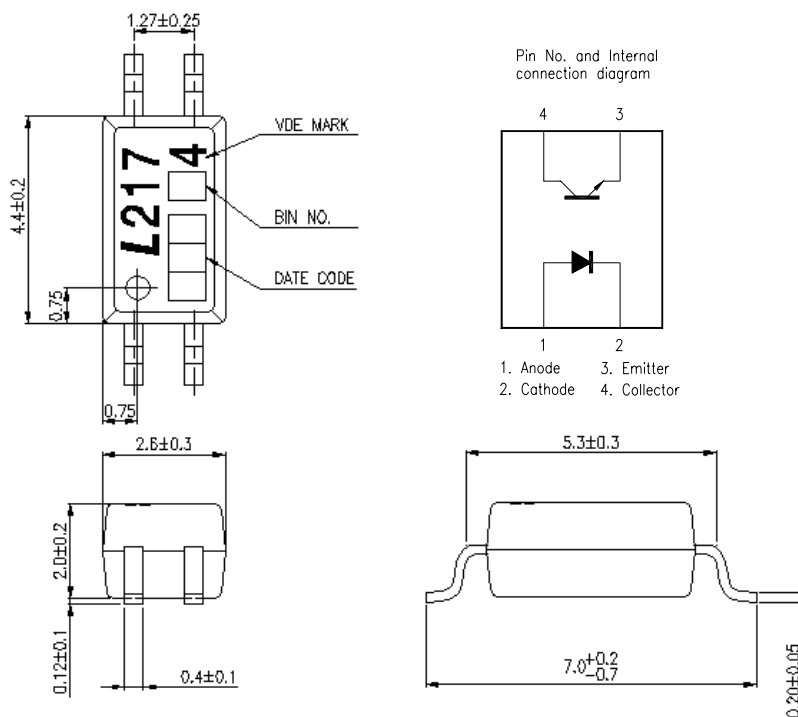

*1. 3-digit date code.

*2. Rank shall be or shall not be marked.

OUTLINE DIMENSIONS

LTV-227 :

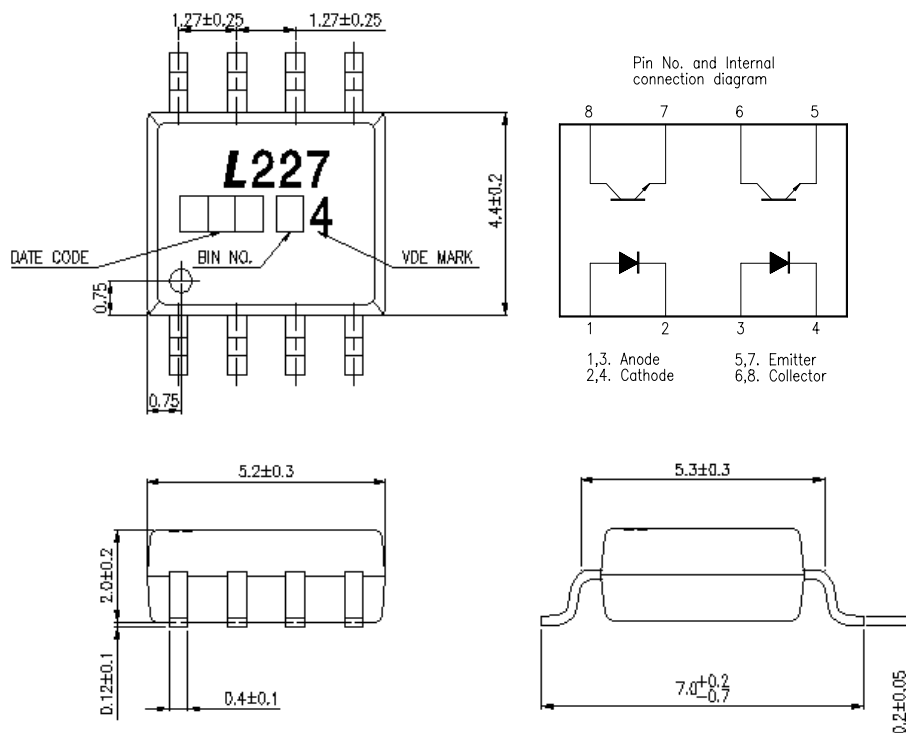

*1. 3-digit date code.

*2. Rank shall be or shall not be marked.

OUTLINE DIMENSIONS

LTV-247 :

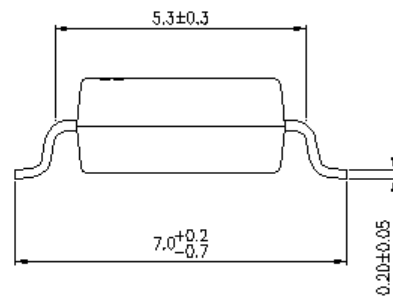
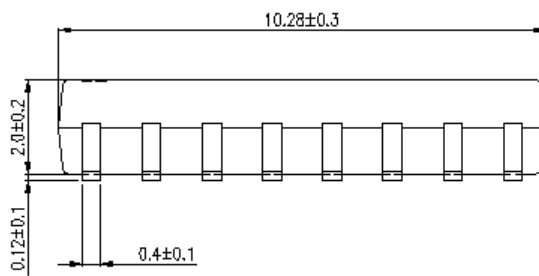
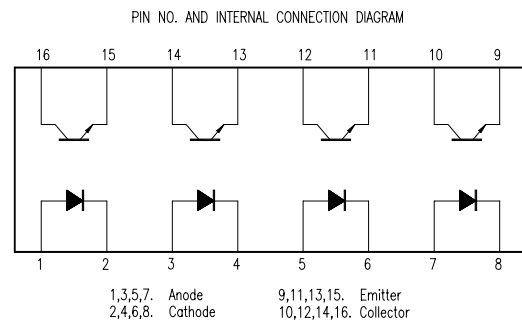
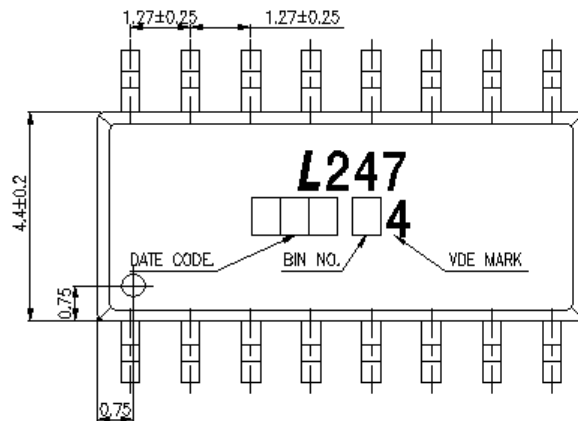

- *1. 3-digit date code.
- *2. Rank shall be or shall not be marked.

TAPING DIMENSIONS

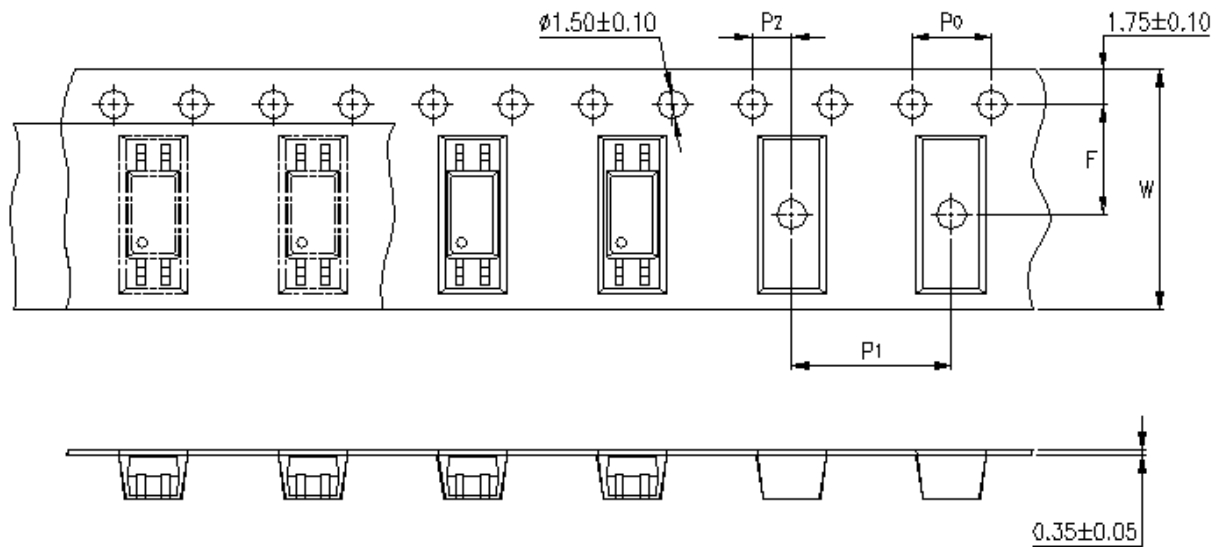

Description	Symbol	Dimension in mm (inches)
Tape wide	W	12 ± 0.3 (.47)
Pitch of sprocket holes	P_0	4 ± 0.1 (.15)
Distance of compartment	F	5.5 ± 0.1 (.217)
	P_2	2 ± 0.1 (.079)
Distance of compartment to compartment	P_1	8 ± 0.1 (.315)

TAPING DIMENSIONS

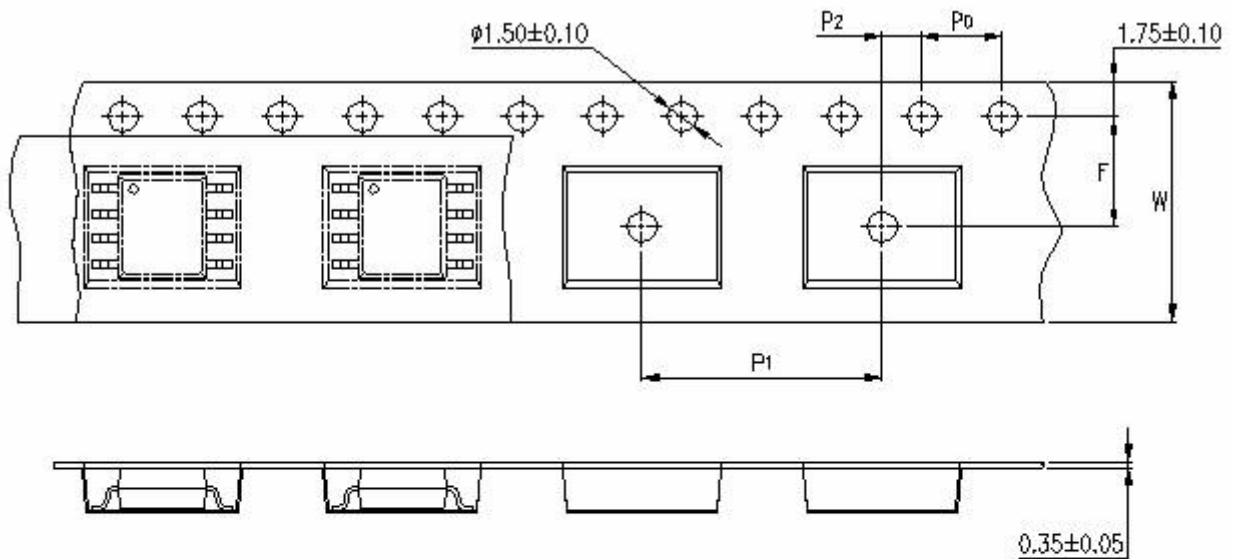

Description	Symbol	Dimension in mm (inches)
Tape wide	W	12 ± 0.3 (.47)
Pitch of sprocket holes	P_0	4 ± 0.1 (.15)
Distance of compartment	F P_2	5.5 ± 0.1 (.217) 2 ± 0.1 (.079)
Distance of compartment to compartment	P_1	12 ± 0.1 (.315)

TAPING DIMENSIONS

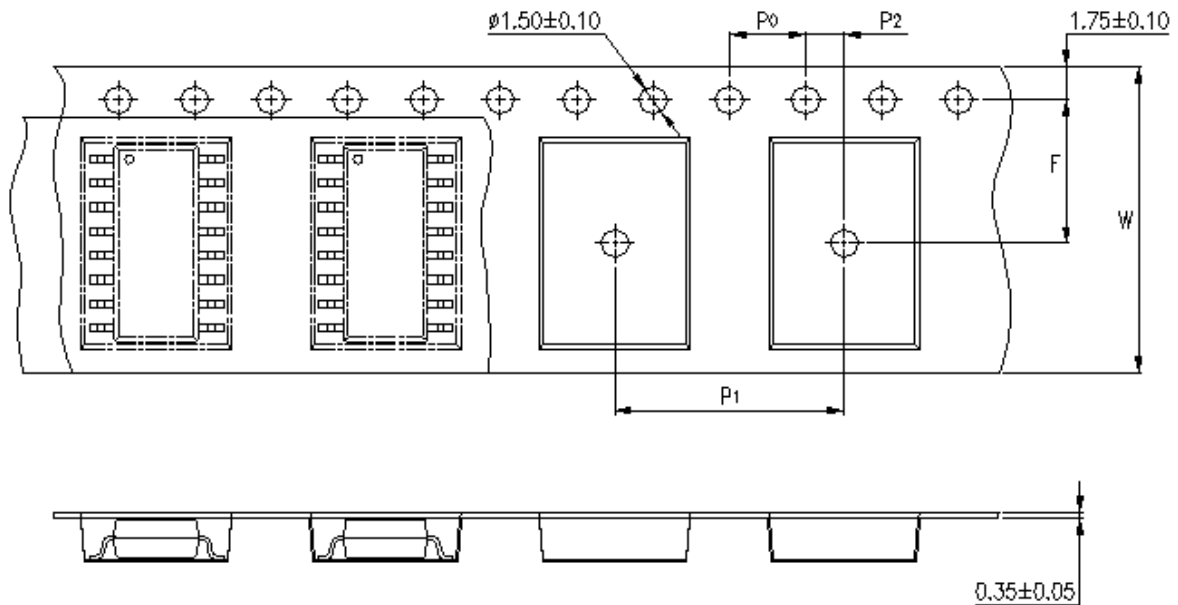

Description	Symbol	Dimension in mm (inches)
Tape wide	W	16 ± 0.3 (.47)
Pitch of sprocket holes	P ₀	4 ± 0.1 (.15)
Distance of compartment	F	7.5 ± 0.1 (.217)
	P ₂	2 ± 0.1 (.079)
Distance of compartment to compartment	P ₁	12 ± 0.1 (.63)

Quantities per Reel :

Package Type	LTV-217	LTV-227	LTV-247
Quantities (pcs)	3000	2000	2000

ABSOLUTE MAXIMUM RATING

(Ta = 25°C)

PARAMETER		SYMBOL	RATING			UNIT
			217	227	247	
INPUT	Forward Current	I _F	50			mA
	Reverse Voltage	V _R	6			V
	Power Dissipation	P	70			mW
OUTPUT	Collector - Emitter Voltage	V _{CEO}	70			V
	Emitter - Collector Voltage	V _{ECO}	7			V
	Collector Current	I _C	50			mA
	Collector Power Dissipation	P _C	150	100		mW
Total Power Dissipation		P _{tot}	200	170		mW
*1	Isolation Voltage	V _{iso}	3,000			V _{rms}
Operating Temperature		T _{opr}	-55 ~ +100			°C
Storage Temperature		T _{stg}	-55 ~ +150			°C
*2	Soldering Temperature	T _{sol}	260 (10s)			°C

*1. AC For 1 Minute, R.H. = 40 ~ 60%

Isolation voltage shall be measured using the following method.

- (1) Short between anode and cathode on the primary side and between collector and emitter on the secondary side.
- (2) The isolation voltage tester with zero-cross circuit shall be used.
- (3) The waveform of applied voltage shall be a sine wave.

*2. For 10 Seconds

ELECTRICAL - OPTICAL CHARACTERISTICS

(Ta = 25°C)

PARAMETER		SYMBOL	MIN.	TYP.	MAX.	UNIT	CONDITIONS
INPUT	Forward Voltage	V_F	—	1.2	1.4	V	$I_F=20mA$
	Reverse Current	I_R	—	—	10	μA	$V_R=4V$
	Terminal Capacitance	C_t	—	30	250	pF	$V=0, f=1KHz$
OUTPUT	Collector Dark Current	I_{CEO}	—	—	100	nA	$V_{CE}=V, I_F=0$
	Collector-Emitter Breakdown Voltage	BV_{CEO}	80	—	—	V	$I_C=0.1mA$ $I_F=0$
	Emitter-Collector Breakdown Voltage	BV_{ECO}	7	—	—	V	$I_E=10\mu A$ $I_F=0$
TRANSFER CHARACTERISTICS	Collector Current	I_C	2.5	—	30	mA	$I_F=5mA$
	*1 Current Transfer Ratio	CTR	50	—	600	%	$V_{CE}=5V$
	Saturated Current	$I_{C(sat)}$	—	4.8	—	mA	$I_F=8mA$
	Saturated CTR	$CTR_{(sat)}$	—	60	—	%	$V_{CE}=2.4V$
	Collector-Emitter Saturation Voltage	$V_{CE(sat)}$	—	—	0.4	V	$I_F=2.4mA$ $I_C=8mA$
	Isolation Resistance	R_{iso}	5×10^{10}	1×10^{11}	—	Ω	DC500V 40 ~ 60% R.H.
	Floating Capacitance	C_f	—	0.6	1	pF	$V=0, f=1MHz$
	Response Time (Rise)	t_r	—	2	—	μs	$V_{CE}=10V, I_C=2mA$ $R_L=100\Omega$
	Response Time (Fall)	t_f	—	3	—	μs	
	Turn-On Time	t_{ON}	—	3	—	us	
	Turn-Off Time	t_{OFF}	—	3	—	us	
	Turn-On Time	t_{ON}	—	2	—	us	
	Storage Time	t_s	—	25	—	us	$V_{CE}=5V, I_C=16mA$ $R_L=1.9K\Omega$
Turn-Off Time	t_{OFF}	—	40	—	us		

$$*1 \text{ CTR} = \frac{I_C}{I_F} \times 100\%$$

RANK TABLE OF CURRENT TRANSFER RATIO CTR

MODEL NO.	RANK MARK	CTR (%)
LTV-217	A	80 ~ 160
	B	130 ~ 260
	C	200 ~ 400
	D	300 ~ 600
	A or B or C or D or E or F or No mark	50 ~ 600
LTV-227 LTV-247	A or B or C or D or E or F or No mark	50 ~ 600

CONDITIONS	$I_F = 5 \text{ mA}$ $V_{CE} = 5 \text{ V}$ $T_a = 25 \text{ }^\circ\text{C}$
-------------------	---

CHARACTERISTICS CURVES

Fig1. Forward current vs. ambient temperature

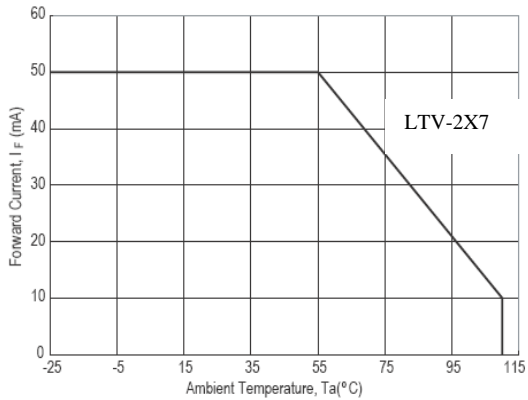

Fig2. Collector power dissipation vs. ambient temperature

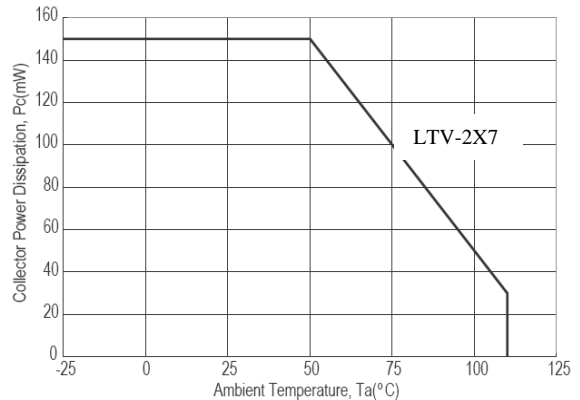

Fig3. Pulse forward current vs. duty cycle

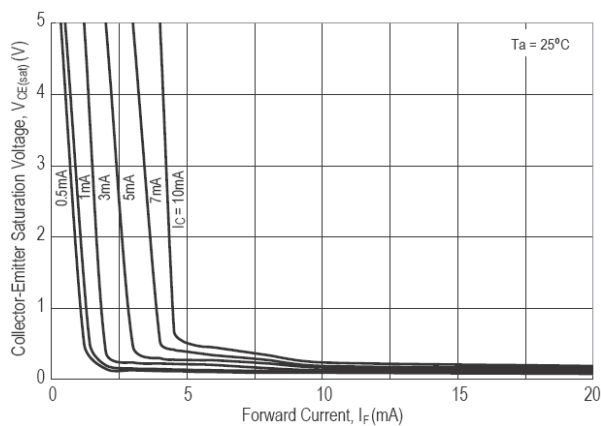

Fig4. Forward current vs. forward voltage

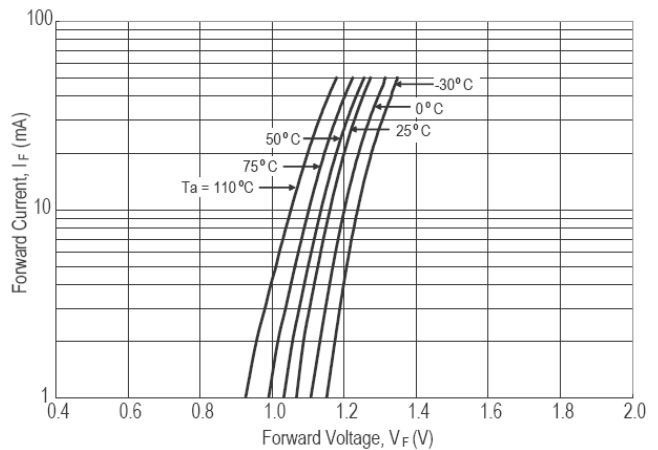

Fig5. Current transfer ratio vs. forward current

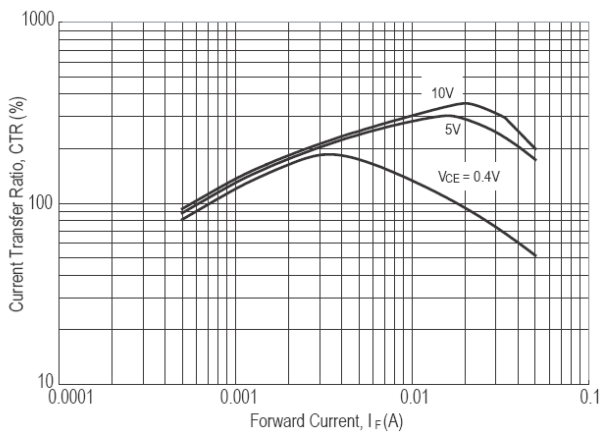
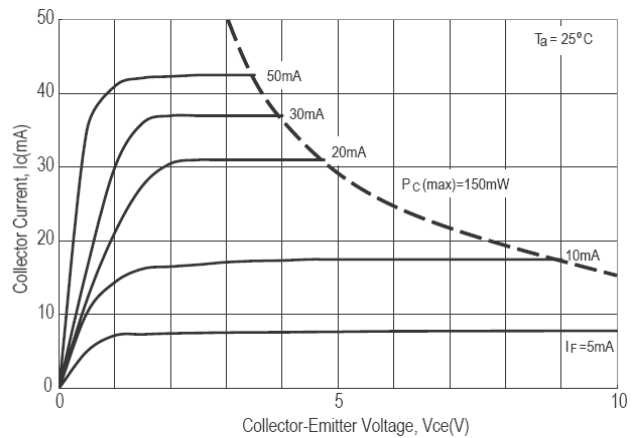

Fig6. Collector current vs. collector-emitter voltage



CHARACTERISTICS CURVES

Fig7. Collector-emitter saturation voltage vs. ambient temperature

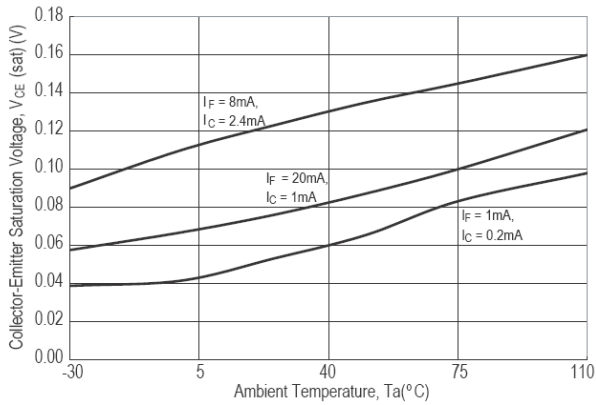

Fig8. Collector dark current vs. ambient temperature

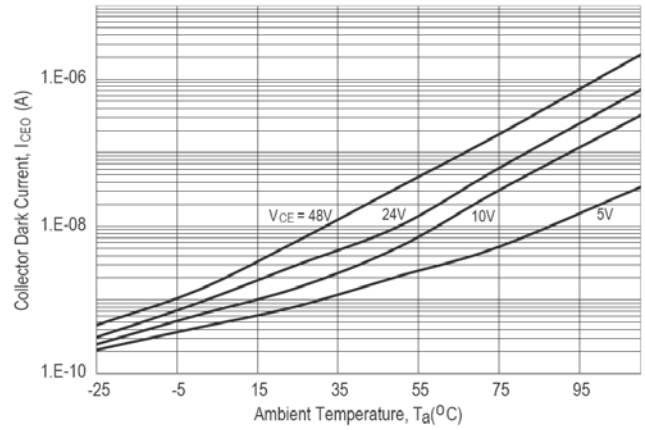

Fig9. Response time vs. load resistance

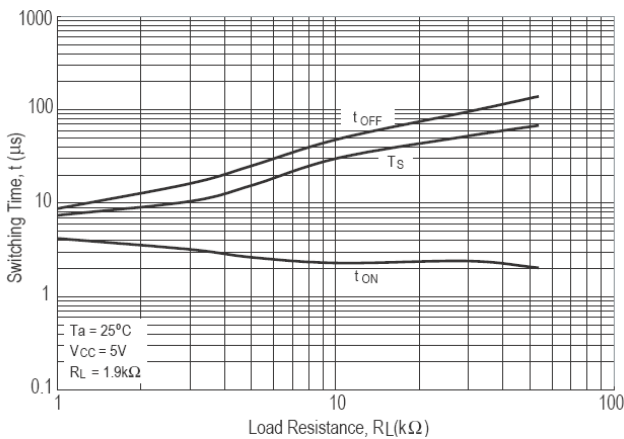
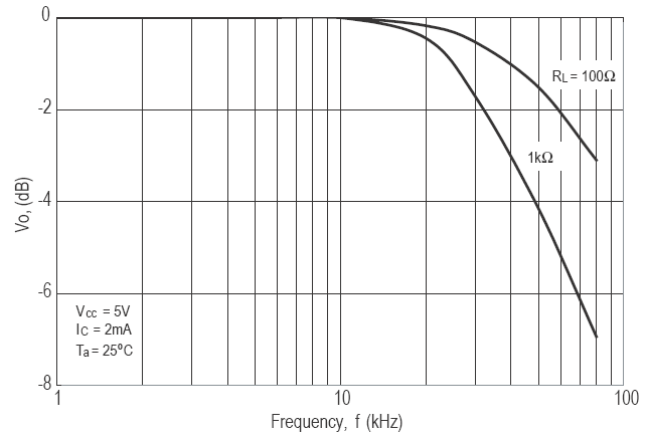
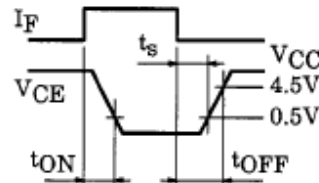
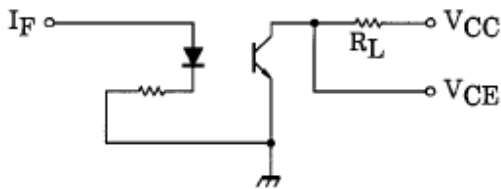

Fig10. Frequency Response



SWITCHING TIME TEST CIRCUIT



Test Circuit for Frequency Response

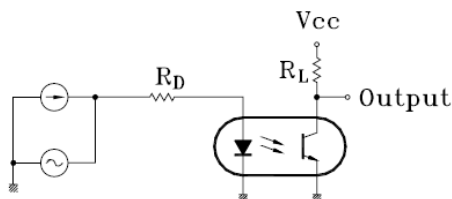

Notes:

- Lite-On is continually improving the quality, reliability, function or design and Lite-On reserves the right to make changes without further notices.
- The products shown in this publication are designed for the general use in electronic applications such as office automation equipment, communications devices, audio/visual equipment, electrical application and instrumentation.
- For equipment/devices where high reliability or safety is required, such as space applications, nuclear power control equipment, medical equipment, etc, please contact our sales representatives.
- When requiring a device for any " specific" application, please contact our sales in advice.
- If there are any questions about the contents of this publication, please contact us at your convenience.

The contents described herein are subject to change without prior notice.

Mouser Electronics

Authorized Distributor

Click to View Pricing, Inventory, Delivery & Lifecycle Information:

[Lite-On:](#)

[LTV-247](#)