

MAX9060–MAX9064

Ultra-Small, Low-Power Single Comparators in 4-Bump UCSP and 5 SOT23

General Description

The MAX9060–MAX9064 are small single comparators, ideal for a wide variety of portable electronics applications such as cell phones, media players, and notebooks that have extremely tight board space and power constraints. These comparators are offered in both, a miniature 4-bump UCSP™ package with a 1mm x 1mm footprint (as small as two 0402 resistors), and a 5-pin SOT23 package.

The MAX9060–MAX9064 feature an input voltage range of -0.3V to +5.5V independent of supply voltage. These devices maintain high impedance at the inputs even when powered down (V_{CC} or $V_{REF} = 0V$). They also feature internal filtering to provide high RF immunity.

The MAX9060 and MAX9061 have open-drain outputs and draw quiescent supply current from a user-supplied reference voltage, V_{REF} , between 0.9V and 5.5V. These devices consume only 100nA (max) supply current and operate over the extended -40°C to +85°C temperature range.

The MAX9062, MAX9063 and MAX9064 are single comparators with an internal 0.2V reference. These devices feature either a push-pull or an open-drain output. They consume only 700nA (max) supply current. The MAX9062, MAX9063, and MAX9064 operate down to $V_{CC} = 1V$ over the extended -40°C to +85°C temperature range.

Applications

- Cell Phones
- Portable Media Players
- Electronic Toys
- Notebook Computers
- Portable Medical Devices

Selector Guide and Typical Operating Circuits appears at end of data sheet.

Pin Configurations

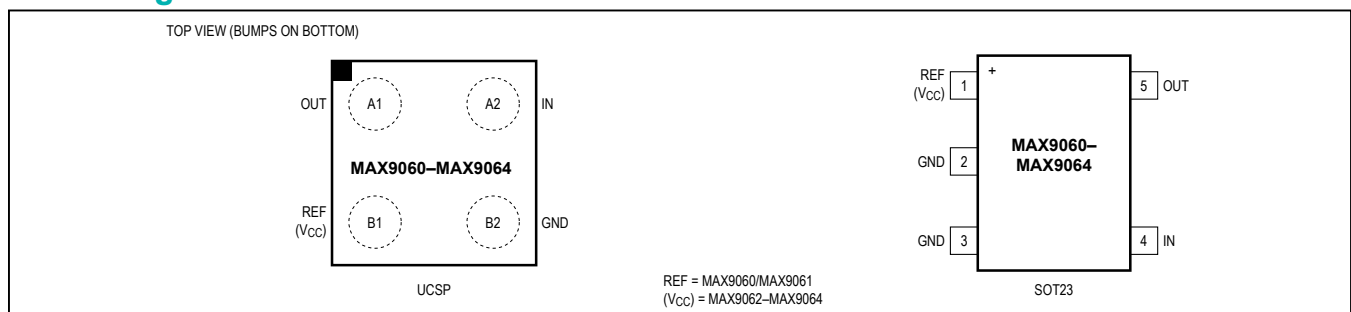

Features

- Tiny 1mm x 1mm x 0.6mm 4-Bump UCSP
- Footprint = Two 0402 Resistors
- Also Available in a 5-Pin SOT23 Package
- Ultra-Low Operating Current (100nA max)
- Input Voltage Range = -0.3V to +5.5V
- External REF Range = 0.9V to 5.5V (MAX9060/MAX9061)
- Internal REF Voltage = 0.2V (MAX9062/MAX9063/MAX9064)
- 15μs Propagation Delay
- -40°C to +85°C Extended Temperature Range

Ordering Information

PART	PIN PACKAGE	TOP MARK
MAX9060EBS+G45	4 UCSP	AFX
MAX9060EUK+	5 SOT23	AFFG
MAX9061EBS+G45	4 UCSP	AFY
MAX9061EUK+	5 SOT23	AFFH
MAX9062EBS+G45	4 UCSP	AFZ
MAX9062EUK+	5 SOT23	AFFI
MAX9063EBS+G45	4 UCSP	AFA
MAX9063EUK+	5 SOT23	AFFJ
MAX9063EUK/V+T	5 SOT23	+AMGH
MAX9064EBS+G45	4 UCSP	AFB
MAX9064EUK+	5 SOT23	AFFK

Note: All devices are specified over the extended -40°C to +85°C operating temperature range.

+Denotes a lead(Pb)-free/RoHS-compliant package.

/V denotes an automotive qualified device.

T = Tape and reel.

G45 = Protective die coating.

UCSP is a trademark of Maxim Integrated Products, Inc.

Absolute Maximum Ratings

V _{CC} , REF, IN to GND.....	-0.3V to +6V	Operating Temperature Range.....	-40°C to +85°C
OUT to GND (MAX9060–MAX9063).....	-0.3V to +6V	Junction Temperature.....	+150°C
OUT to GND (MAX9064 Only).....	-0.3V to + (V _{CC} + 0.3V)	Storage Temperature Range.....	-65°C to +150°C
Output Short-Circuit Current Duration.....	10s	Lead Temperature (excluding UCSP, soldering, 10s).....	+300°C
Input Current into Any Terminal.....	±20mA	Soldering Temperature (reflow).....	+260°C
Continuous Power Dissipation			
4-Bump UCSP (derate 3.0mW/°C above +70°C).....	238mW		
5-Pin SOT23 (derate 3.9mW/°C above +70°C).....	312mW		

Stresses beyond those listed under "Absolute Maximum Ratings" may cause permanent damage to the device. These are stress ratings only, and functional operation of the device at these or any other conditions beyond those indicated in the operational sections of the specifications is not implied. Exposure to absolute maximum rating conditions for extended periods may affect device reliability.

MAX9060/MAX9061 Electrical Characteristics

(V_{REF} = 1.8V, R_{PULLUP} = 10kΩ to V_{PULLUP} = 3.3V, T_A = -40°C to +85°C. Typical values are at T_A = +25°C, unless otherwise noted.) (Note 1)

PARAMETER	SYMBOL	CONDITIONS	MIN	TYP	MAX	UNITS
DC CHARACTERISTICS						
Input Offset Voltage (Note 2)	V _{OS}	T _A = +25°C		1.3	6	mV
					9	
Hysteresis	V _{HYS}	(Note 3)		±12		mV
Input Voltage Range	V _{IN}		-0.3		+5.5	V
Input Bias Current	I _{IN}	0V < V _{IN} < V _{REF} + 0.6V			40	nA
		V _{REF} + 0.6V < V _{IN} < 5.5V		10	100	
Input Shutdown Current	I _{IN_PD}	V _{REF} = 0V, V _{IN} = 5.5V (Note 4)		<0.1	27	nA
Output Voltage Low	V _{OL}	I _{SINK} = 25µA, V _{REF} = 0.9V, T _A = +25°C		0.04	0.20	V
		I _{SINK} = 200µA, V _{REF} = 1.2V		0.08	0.20	
		I _{SINK} = 500µA, V _{REF} = 1.8V		0.13	0.23	
		I _{SINK} = 1.2mA, V _{REF} = 5.5V		0.19	0.50	
Output Leakage Current (OUT = High)	I _{OUT_LEAKAGE}	V _{PULLUP} = 5.5V (Note 4)		<0.1	35	nA
AC CHARACTERISTICS						
Propagation Delay	t _{PD}	Overdrive = ±100mV (Note 5)		25		µs
Fall Time	t _F	C _L = 10pF		14		ns
REF SUPPLY						
REF Voltage	V _{REF}	Guaranteed by V _{OS} tests	0.9		5.5	V
REF Input Current	I _{REF}	V _{REF} = 0.9V, V _{IN} = V _{REF} , T _A = +25°C		50		nA
		V _{REF} = 1.8V, V _{IN} = V _{REF} , T _A = +25°C		60		
		V _{REF} = 5.5V, V _{IN} = V _{REF} , T _A = +25°C		170	320	
		V _{REF} = 5.5V, V _{IN} = V _{REF} , -40°C < T _A < +85°C			350	
REF Rejection Ratio	RRR	V _{REF} = 0.9V to 5.5V, T _A = +25°C	63	90		dB
Power-Up Time	t _{ON}			3		ms

MAX9062/MAX9063/MAX9064 Electrical Characteristics

($V_{CC} = 3.3V$, $R_{PULLUP} = 10k\Omega$ to $V_{PULLUP} = 3.3V$ for MAX9062/MAX9063, $T_A = -40^\circ C$ to $+85^\circ C$. Typical values at $T_A = +25^\circ C$, unless otherwise noted.) (Note 1)

PARAMETER	SYMBOL	CONDITIONS	MIN	TYP	MAX	UNITS
DC CHARACTERISTICS						
Input Voltage Range	V_{IN}	Guaranteed by I_{IN} test	-0.3		+5.5	V
Input Bias Current	I_{IN}	$V_{IN} = 0.2V$ to $5.5V$ (Note 4)		0.06	15	nA
Input Leakage Current	I_{IN_SHDN}	$V_{CC} = 0V$, $V_{IN} = 5.5V$ (Note 4)		<0.1	15	nA
Output Voltage Low	V_{OL}	$I_{SINK} = 50\mu A$, $V_{CC} = 1.0V$		0.03	0.2	V
		$I_{SINK} = 200\mu A$, $V_{CC} = 1.2V$		0.08	0.20	
		$I_{SINK} = 500\mu A$, $V_{CC} = 1.8V$		0.13	0.23	
		$I_{SINK} = 0.75mA$, $V_{CC} = 3.3V$		0.14	0.3	
		$I_{SINK} = 1.2mA$, $V_{CC} = 5.5V$		0.19	0.5	
Output Voltage High (MAX9064 Only)	V_{OH}	$I_{SOURCE} = 15\mu A$, $V_{CC} = 1.0V$		$V_{CC} - 0.08V$	$V_{CC} - 0.02V$	V
		$I_{SOURCE} = 40\mu A$, $V_{CC} = 1.2V$		$V_{CC} - 0.08V$	$V_{CC} - 0.20V$	
		$I_{SOURCE} = 180\mu A$, $V_{CC} = 1.8V$		$V_{CC} - 0.15V$	$V_{CC} - 0.23V$	
		$I_{SOURCE} = 0.3mA$, $V_{CC} = 3.3V$		$V_{CC} - 0.13V$	$V_{CC} - 0.3V$	
		$I_{SOURCE} = 0.75mA$, $V_{CC} = 5.5V$		$V_{CC} - 0.24V$	$V_{CC} - 0.5V$	
Output Leakage Current (MAX9062/MAX9063 Only)	$I_{OUT_LEAKAGE}$	OUT = high, $V_{PULLUP} = 5.5V$ (Note 4)		<0.1	15	nA
AC CHARACTERISTICS						
Propagation Delay	t_{PD}	$V_{OVERDRIVE} = \pm 100mV$ (Note 5)		15		μs
Fall Time	t_F	$C_L = 10pF$		14		ns
Rise Time	t_R	$C_L = 10pF$, MAX9064 only		30		ns
REFERENCE VOLTAGE						
Input Threshold (Note 6)	V_{REF}	$T_A = +25^\circ C$	188	200	212	mV
		$T_A = -40^\circ C$ to $+85^\circ C$	185	200	215	
Input Threshold Hysteresis	V_{HYS}	$T_A = -40^\circ C$ to $+85^\circ C$ (Note 3)		± 0.9		mV
REF Tempco	V_{REF_TEMPCO}	(Note 7)		6		$\mu V/^\circ C$
Power-Supply Rejection Ratio	PSRR	$V_{CC} = 1.0V$ to $5.5V$	40	53		dB
POWER SUPPLY						
Supply Voltage	V_{CC}	Guaranteed by V_{OL}/V_{OH} tests	1.0		5.5	V
Supply Current	I_{CC}	$V_{CC} = 1.0V$		0.4	0.7	μA
		$V_{CC} = 5.5V$		0.6	1.1	
Power-Up Time	t_{ON}			3		ms

Note 1: All devices are 100% production tested at $T_A = +25^\circ C$. Temperature limits are guaranteed by design.

Note 2: Guaranteed by ATE and/or bench characterization over temperature. V_{OS} is the average of the trip points minus V_{REF} .

Note 3: Hysteresis is half the input voltage difference between the two switching points.

Note 4: Too small to be measured in an ATE test environment. Only gross test to catch failures is implemented.

Note 5: Overdrive is defined as the voltage above or below the switching points.

Note 6: Guaranteed by ATE and/or bench characterization over temperature. V_{REF} is the average of the trip points.

Note 7: Includes reference error along with comparator offset voltage error.

Typical Operating Characteristics

($V_{CC} = 3.3V$, $V_{REF} = 1.8V$, $R_{PULLUP} = 10k\Omega$ to $V_{PULLUP} = 3.3V$ for MAX9060–MAX9063, $V_{GND} = 0V$, $T_A = +25^\circ C$, unless otherwise noted.)

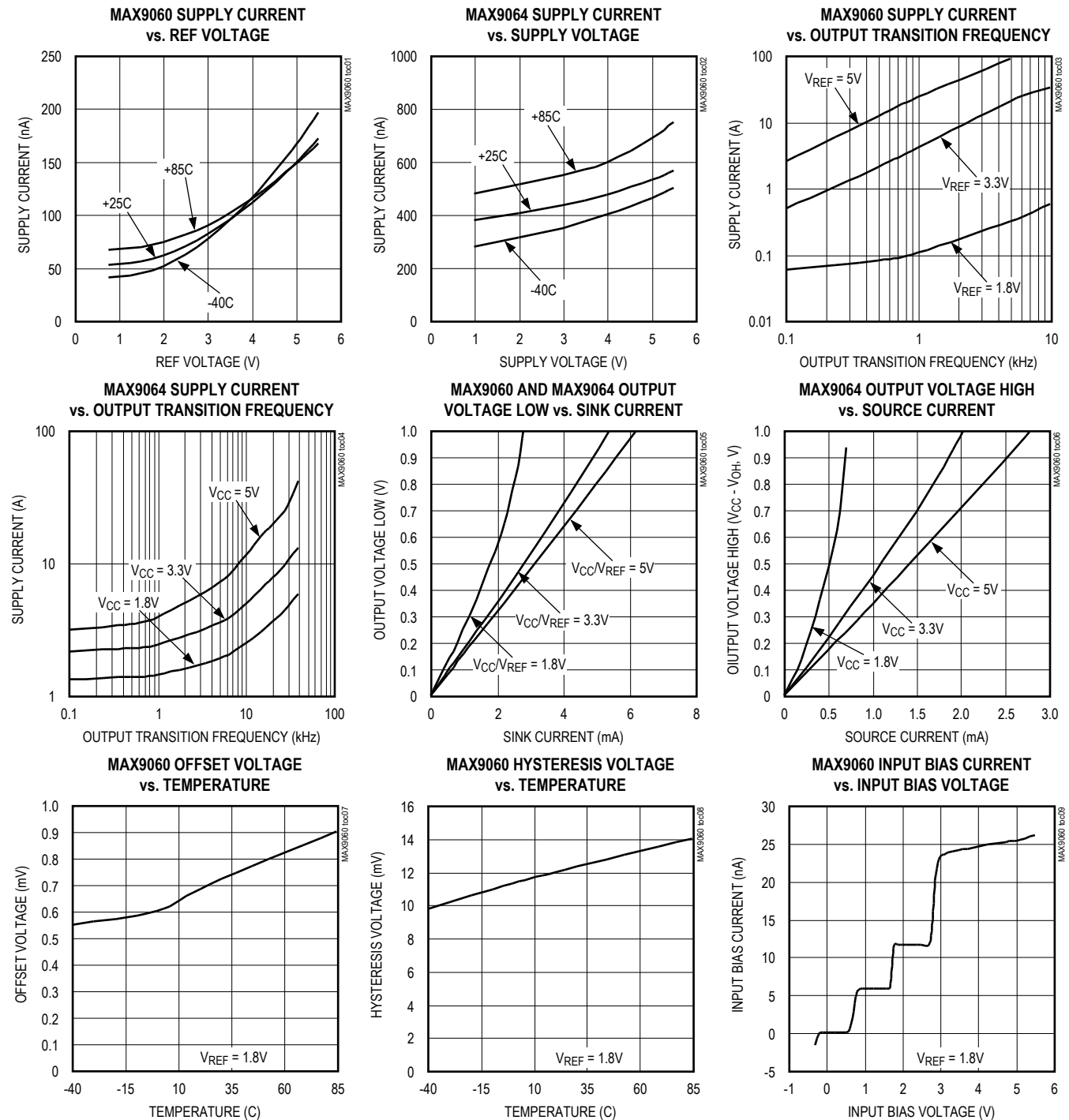

Typical Operating Characteristics (continued)

($V_{CC} = 3.3V$, $V_{REF} = 1.8V$, $R_{PULLUP} = 10k\Omega$ to $V_{PULLUP} = 3.3V$ for MAX9060–MAX9063, $V_{GND} = 0V$, $T_A = +25^\circ C$, unless otherwise noted.)

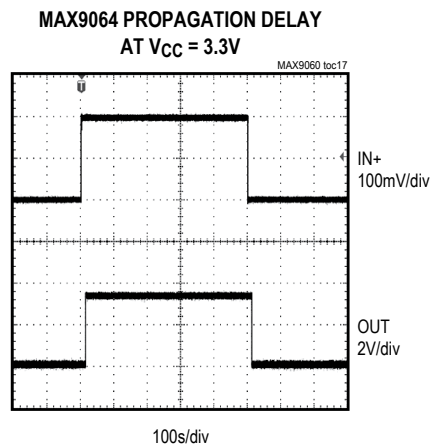
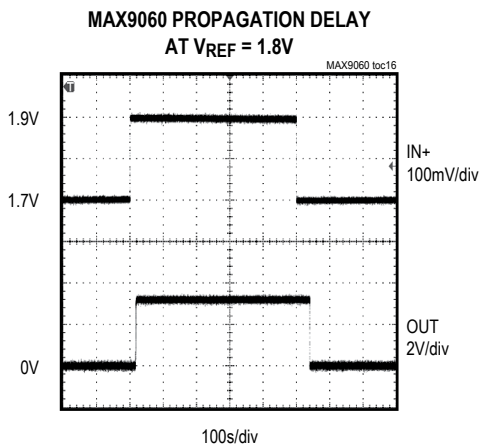
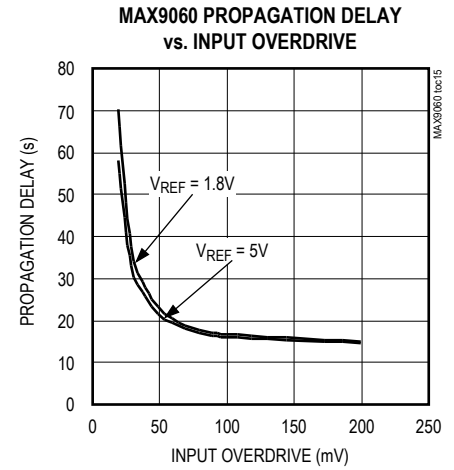
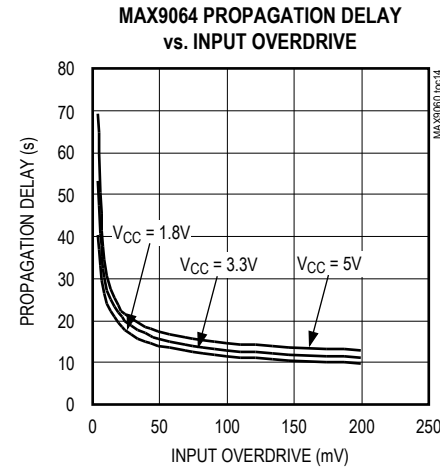
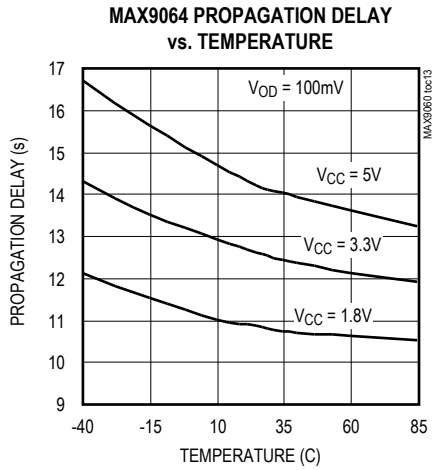
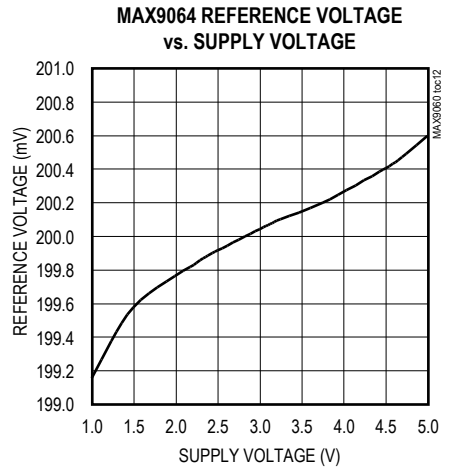
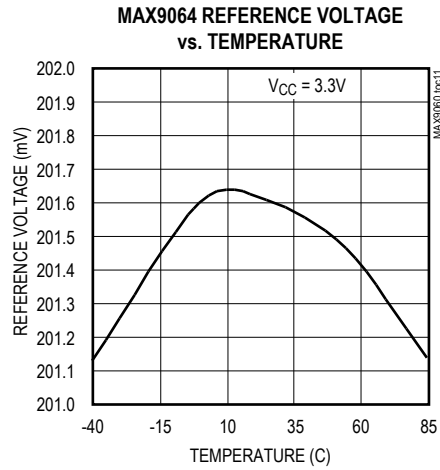
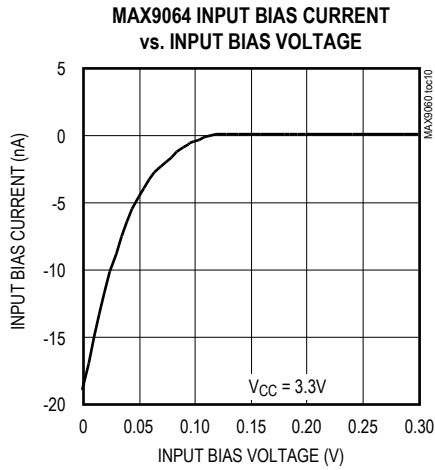

Typical Operating Characteristics (continued)

($V_{CC} = 3.3V$, $V_{REF} = 1.8V$, $R_{PULLUP} = 10k\Omega$ to $V_{PULLUP} = 3.3V$ for MAX9060–MAX9063, $V_{GND} = 0V$, $T_A = +25^\circ C$, unless otherwise noted.)

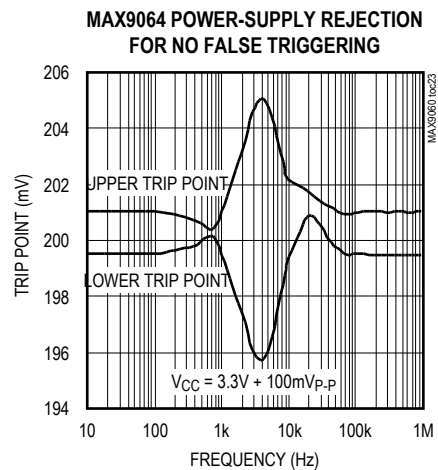
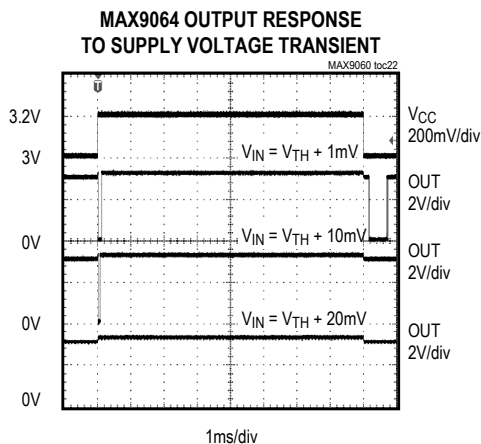
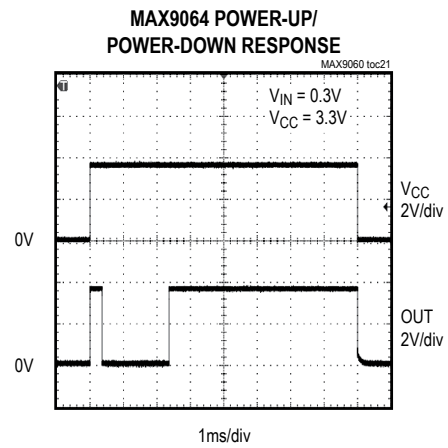
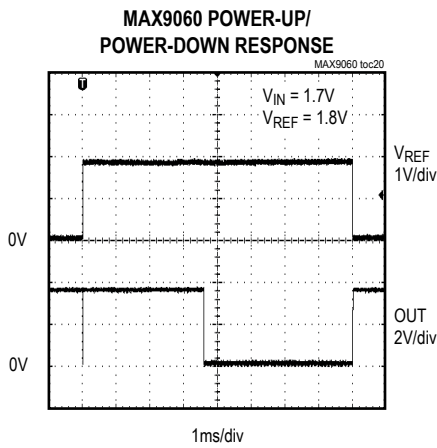
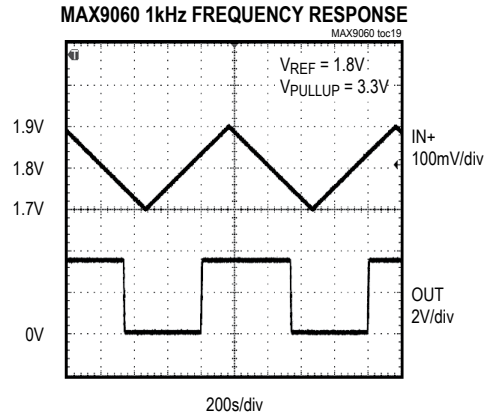
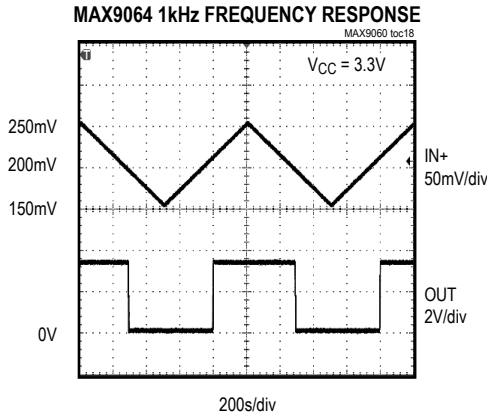

Pin/Bump Description

BUMP		PIN		NAME	FUNCTION
UCSP		SOT23			
MAX9060 MAX9061	MAX9062 MAX9063 MAX9064	MAX9060 MAX9061	MAX9062 MAX9063 MAX9064		
A1	A1	5	5	OUT	Comparator Output. The MAX9060–MAX9063 have open-drain outputs. The MAX9064 has a push-pul output.
A2	A2	4	4	IN	Comparator Input. The MAX9060, MAX9062, and MAX9064 have noninverting inputs. The MAX9061 and MAX9063 have inverting inputs.
—	B1	—	1	V _{CC}	Power-Supply Voltage. Bypass to ground with a 0.1µF bypass capacitor.
B1	—	1	—	REF	External Reference Input. REF also supplies power to the device. Bypass to ground with a 0.1µF bypass capacitor.
B2	B2	2, 3	2, 3	GND	GROUND.

Detailed Description

The MAX9060–MAX9064 are extremely small comparators ideal for compact, low-current, and low-voltage applications.

The MAX9060/MAX9061 consume only 50nA (typ) operating current, while the MAX9062/MAX9063/MAX9064 consume only 400nA (typ). The low-voltage operating capability of the MAX9060–MAX9064 makes these devices extremely attractive to long-life battery-operated devices—these applications can now use a single digital power-supply rail to power the new generation of microcontrollers (which can be down to 0.9V). A single AA/AAA cell can drop down to 0.9V in full discharge. All parts are available in a tiny 4-bump UCSP, that is only 0.6mm tall, and occupies a 1mm x 1mm footprint and a 5-pin SOT23.

Input Stage Circuitry

Noninverting inputs are available on the MAX9060/MAX9062/MAX9064 and inverting inputs are available on the MAX9061/MAX9063.

The MAX9060–MAX9064 incorporate an innovative input stage architecture that allows their input voltage to exceed V_{CC} by several volts (limited only by the

Absolute Maximum Ratings). This is unlike traditional comparators that have an input ESD diode clamp between the input and V_{CC}, limiting this maximum over-voltage to about 0.3V. The MAX9060–MAX9064 architecture maintains a high input impedance to input signals even when the device power-supply voltage is completely turned off (V_{CC} or REF taken to 0V). This greatly benefits flexible power-saving schemes to be easily implemented in advanced battery-operated devices. On-chip filtering provides immunity from any RF noise being picked up by input traces. These devices feature an internal temperature-compensated, low-power 0.2V reference voltage.

Output Stage Structure

The MAX9060–MAX9063 have open-drain outputs that allow them to interface to logic circuitry running from supply voltages other than the one supplied to the part. These devices require an external pullup resistor or current source for proper operation. Many microcontroller digital inputs ports can be readily programmed to include these.

The MAX9064 has a push-pull output stage that can both sink and source current, eliminating the need for an external pullup resistor. In this case, the MAX9064 uses the microcontroller's power supply as V_{CC}.

Table 1. How Devices Behave Under Various Input Voltage Conditions

PART	INPUT VOLTAGE CONDITIONS	ACTION AT OUTPUT
MAX9060	$V_{IN} > V_{REF}$	External pullup resistor pulls output high.
	$V_{IN} < V_{REF}$	Output asserts low.
MAX9061	$V_{IN} > V_{REF}$	Output asserts low.
	$V_{IN} < V_{REF}$	External pullup resistor pulls output high.
MAX9062	$V_{IN} > 0.2V$	External pullup resistor pulls output high.
	$V_{IN} < 0.2V$	Output asserts low.
MAX9063	$V_{IN} > 0.2V$	Output asserts low.
	$V_{IN} < 0.2V$	External pullup resistor pulls output high.
MAX9064	$V_{IN} > 0.2V$	Output asserts high.
	$V_{IN} < 0.2V$	Output asserts low.

Applications Information

Bypassing REF/VCC

Place a 0.1µF capacitor between REF or VCC and GND as close as possible to the device. During a switching event, all comparators draw a current spike from their power-supply rails. This current spike is minimized by the use of an internal break-before-make design.

Hysteresis Operation

The MAX9060–MAX9064 feature internal hysteresis for noise immunity and glitch-free operation. If additional hysteresis is needed, an external positive feedback network can be easily implemented on the MAX9060, MAX9062,

and MAX9064 noninverting input devices. Additional external hysteresis is not recommended for the MAX9061 due to possible crossover current-related noise problems. Additional external hysteresis is not possible on the MAX9063 because the noninverting input of the comparator is not externally accessible.

Adaptive Signal Level Detector

The MAX9060 and MAX9061 can be used as an adaptive signal-level detector. Feed a DAC output voltage to REF and connect the input to a variable signal level. As the DAC output voltage is varied from 0.9V to 5.5V, a corresponding signal level threshold-detector circuit is implemented. See [Figure 1](#).

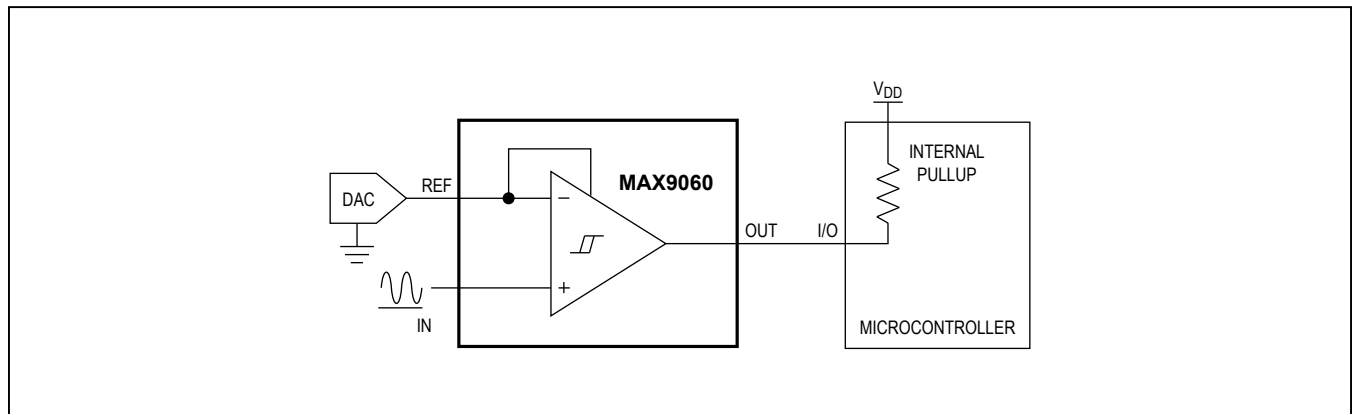
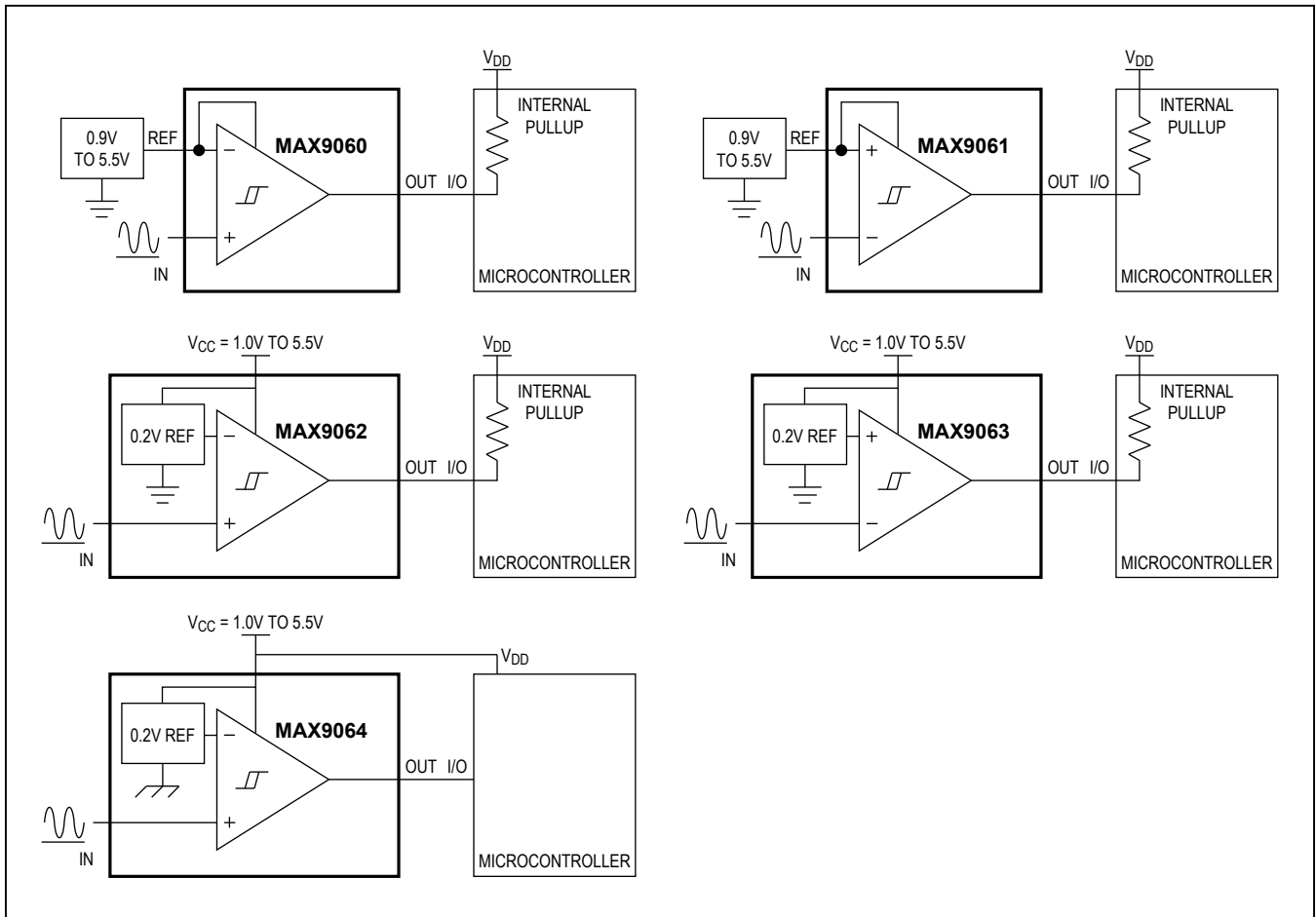

Figure 1. Adaptive Signal Level Detector

Typical Operating Circuits



Selector Guide

PART	REFERENCE VOLTAGE	INPUT	OUTPUT
MAX9060	External	Noninverting	Open drain
MAX9061	External	Inverting	Open drain
MAX9062	0.2V	Noninverting	Open drain
MAX9063	0.2V	Inverting	Open drain
MAX9064	0.2V	Noninverting	Push-pull

Package Information

For the latest package outline information and land patterns (footprints), go to www.maximintegrated.com/packages. Note that a “+”, “#”, or “-” in the package code indicates RoHS status only. Package drawings may show a different suffix character, but the drawing pertains to the package regardless of RoHS status.

PACKAGE TYPE	PACKAGE CODE	OUTLINE NO.	LAND PATTERN NO.
5 SOT23	U5+2	21-0057	90-0174
4 UCSP	B4+1	21-0117	—

Chip Information

PROCESS: BiCMOS

Revision History

REVISION NUMBER	REVISION DATE	DESCRIPTION	PAGES CHANGED
0	5/08	Initial release	—
1	1/09	Corrected ultra-low operating current value	1
2	10/10	Updated TOC 4 labels	4
3	12/10	Added G45 designation	1
4	3/11	Updated Note 6	3
5	8/12	Added automotive package MAX9064EUK/V+T to <i>Ordering Information</i>	1
6	12/14	Added automotive package MAX9063EUK/V+T to <i>Ordering Information</i> and removed MAX9064EUK/V+T	1

For pricing, delivery, and ordering information, please contact Maxim Direct at 1-888-629-4642, or visit Maxim Integrated's website at www.maximintegrated.com.

Maxim Integrated cannot assume responsibility for use of any circuitry other than circuitry entirely embodied in a Maxim Integrated product. No circuit patent licenses are implied. Maxim Integrated reserves the right to change the circuitry and specifications without notice at any time. The parametric values (min and max limits) shown in the Electrical Characteristics table are guaranteed. Other parametric values quoted in this data sheet are provided for guidance.

Mouser Electronics

Authorized Distributor

Click to View Pricing, Inventory, Delivery & Lifecycle Information:

Maxim Integrated:

[MAX9060EBS+TG45](#) [MAX9060EUK+T](#) [MAX9061EBS+TG45](#) [MAX9061EUK+T](#) [MAX9062EBS+TG45](#)
[MAX9062EUK+T](#) [MAX9063EBS+TG45](#) [MAX9063EUK+T](#) [MAX9064EBS+TG45](#) [MAX9064EUK+T](#)