



MIC2514

IttyBitty® Integrated High-Side Switch

General Description

The MIC2514 is an integrated high-side power switch that consists of a TTL compatible input and protected P-channel MOSFET. The MIC2514 can be used instead of a separate high-side driver and MOSFET in many low-voltage applications.

The MIC2514 switches voltage ranging from 3V to 13.5V and delivers more than 400mA continuous current. A slow turn-on feature prevents high inrush current when switching capacitive loads. The internal control circuitry is powered from the unswitched 3V to 13.5V input.

Current limiting is internally fixed at approximately 1.9A and requires no external components.

Thermal shutdown turns off the output if the die temperature exceeds approximately 170°C.

The MIC2514 is available in the 5-pin SOT-23-5 package with a temperature range of -40°C to +85°C.

Datasheets and support documentation can be found on Micrel's web site at: www.micrel.com.

Features

- MOSFET on-resistance
 - 1.5Ω typical at 5V
 - 0.95Ω typical at 12V
- 3V to 13.5V input
- 25μA typical on-state supply current at 5V
- <1μA typical off-state supply current at 5V
- Current limit
- Thermal shutdown
- Slow turn-on

Applications

- 3.3V to 13.5V power management

Ordering Information

Part Number		Temp. Range	Package
Standard	Pb-Free		
MIC2514BM5	MIC2514YM5	-40° to +85°C	5-Pin SOT-23

Typical Application

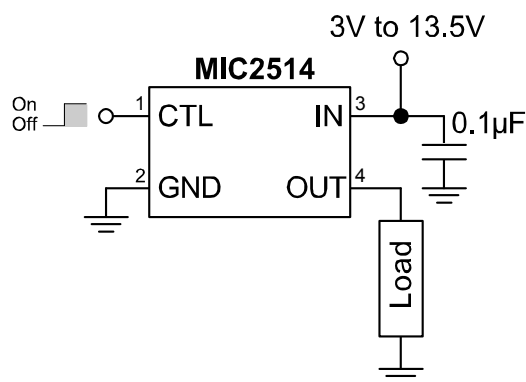

High-Side Power Switch

Pin Configuration

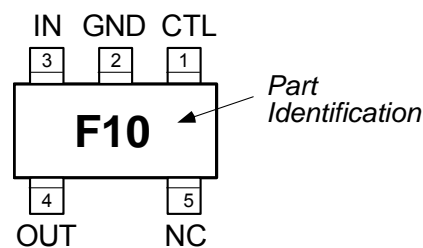

5-Pin SOT-23 (M5)

IttyBitty is a registered trademark of Micrel, Inc.

Micrel Inc. • 2180 Fortune Drive • San Jose, CA 95131 • USA • tel +1 (408) 944-0800 • fax + 1 (408) 474-1000 • <http://www.micrel.com>

Pin Description

Pin Number	Pin Name	Pin Function
1	CTL	Control (Input): Non-inverting TTL compatible control input. High = on, low = off.
2	GND	Ground
3	IN	Supply Input: Output MOSFET source. Also supplies IC's internal circuitry. Connect to supply.
4	OUT	Switch Output: Output MOSFET drain. Connect to switched side of load.
5	NC	Not internally connected. Connect to ground plane for lowest package thermal resistance.

Absolute Maximum Ratings⁽¹⁾

Supply Voltage (V_{IN}).....+20V
 Output Current (I_{OUT})..... Internally Limited
 Control Input (V_{CTL}).....-0.3V to 15V
 Storage Temperature (T_S).....-65°C to +150°C

Operating Ratings⁽²⁾

Supply voltage (V_{IN}) +3V to +13.5V
 Ambient Temperature (T_A) -40°C to +85°C
 Junction Thermal Resistance
 (θ_{JA}) 220°C/W
 (θ_{JC}) 130°C/W
 Control Input (V_{CTRL}).....-0.3V to V_{IN}

Electrical Characteristics

$V_{IN} = 5V$; $T_A = 25^\circ C$, except **bold** values indicate $-40^\circ C \leq T_A \leq +85^\circ C$, **Note 3**; unless noted.

Parameter	Condition	Min	Typ	Max	Units
Supply Current	$V_{CTL} = \text{logic } 0, V_{IN} = 5V$		0.6	10	μA
	$V_{CTL} = \text{logic } 0, V_{IN} = 13.5V$		2.0	25	μA
	$V_{CTL} = \text{logic } 1, V_{IN} = 3V$ $V_{CTL} = \text{logic } 1, V_{IN} = 5V$ $V_{CTL} = \text{logic } 1, V_{IN} = 13.5V$		10 25 95	20 40 200	μA μA μA
Control Input Voltage	$V_{CTL} = \text{logic } 0, 3V \leq V_{IN} \leq 13.5V$	0		0.79	V
	$V_{CTL} = \text{logic } 1, 3V \leq V_{IN} \leq 5V$	0.8	1.45	2.0	V
	$V_{CTL} = \text{logic } 1, 5V \leq V_{IN} \leq 13.5V$	0.8	1.65	2.3	V
Output MOSFET Resistance	$V_{IN} = 3V$		2.4	4.5	Ω
	$V_{IN} = 5V$		1.5	2.4 2.7	Ω
	$V_{IN} = 12V$		0.95	1.5 1.7	Ω Ω
Current Limit Threshold	$V_{IN} = 3V$		0.5	1.5	A
	$V_{IN} = 5V$	1.0	1.4	2.0	A
	$V_{IN} = 12V$	1.2	1.9	2.5	A

General Note: Devices are ESD sensitive. Handling precautions recommended

Notes:

- Exceeding the absolute maximum rating may damage the device.
- The device is not guaranteed to function outside its operating rating.
- Devices production tested at 25°C, but Devices guaranteed over indicated temperature range.

Typical Characteristics

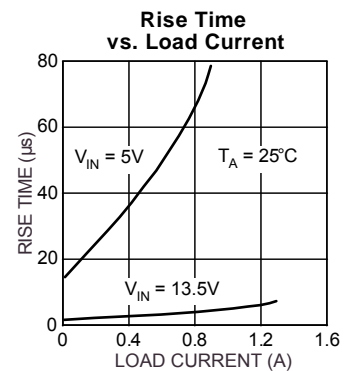
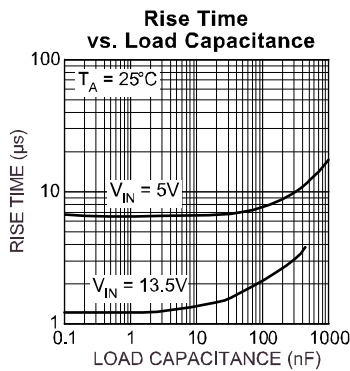
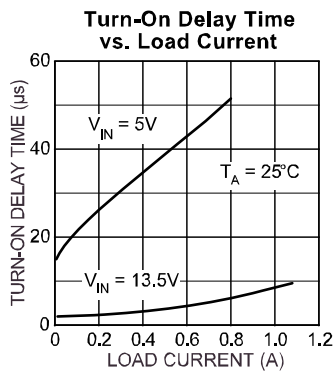
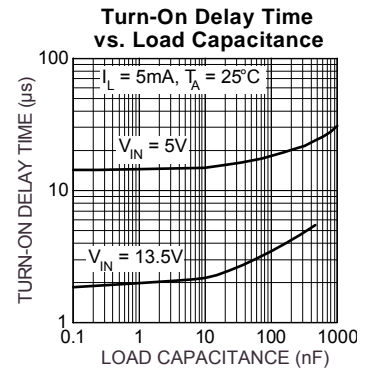
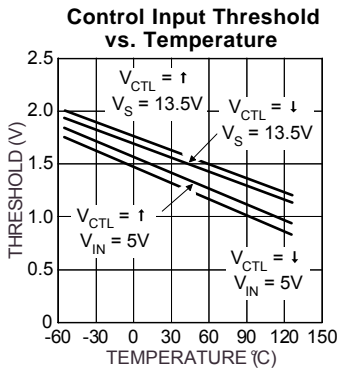
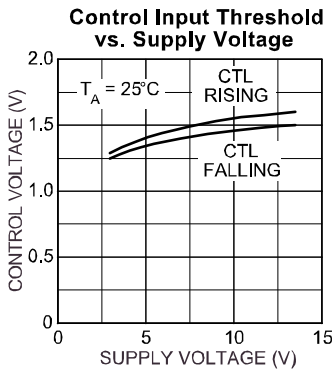
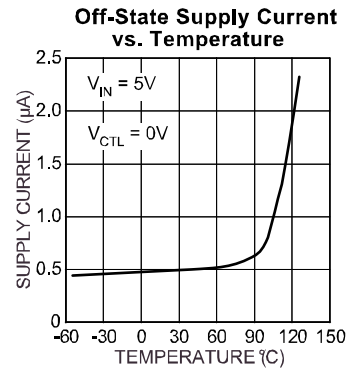
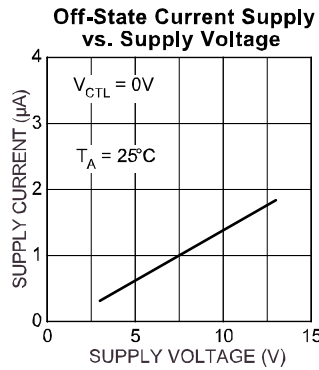
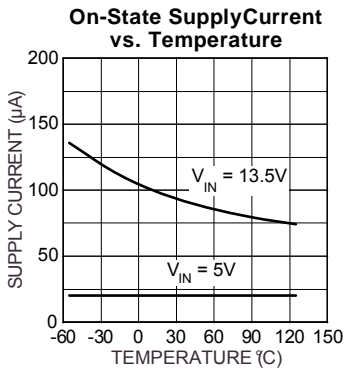
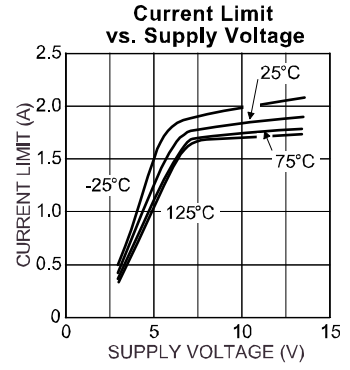
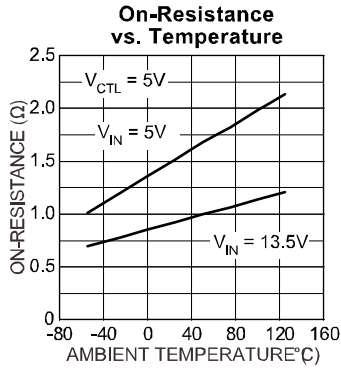
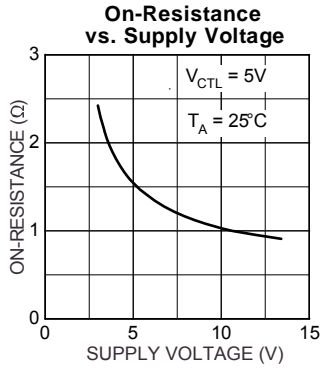

Typical Characteristics (continued)

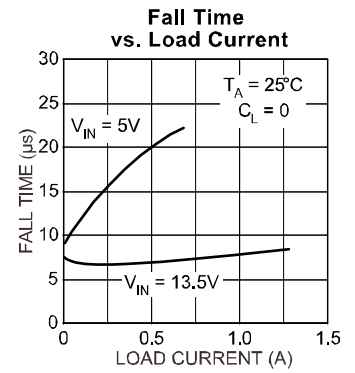
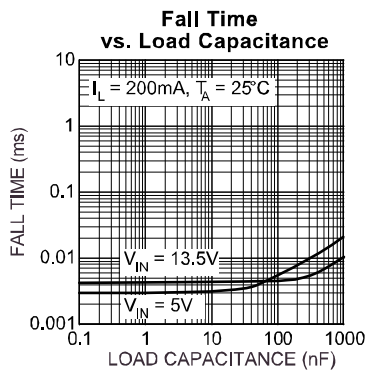
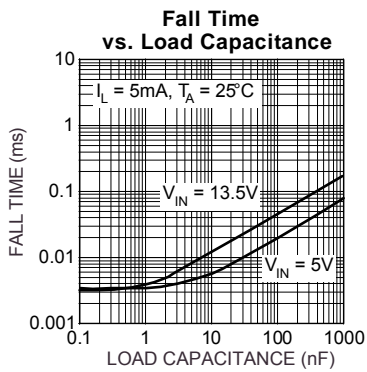
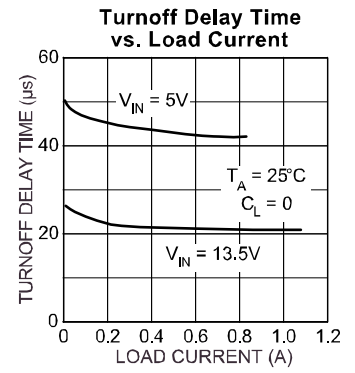
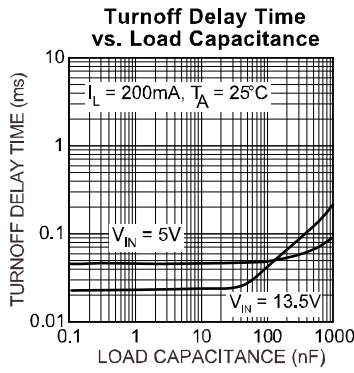
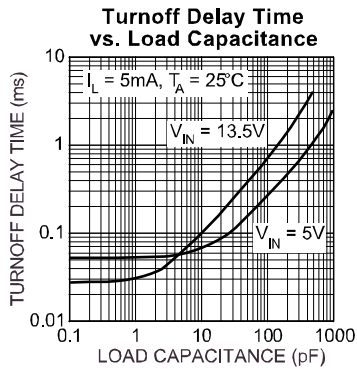

Functional Diagram

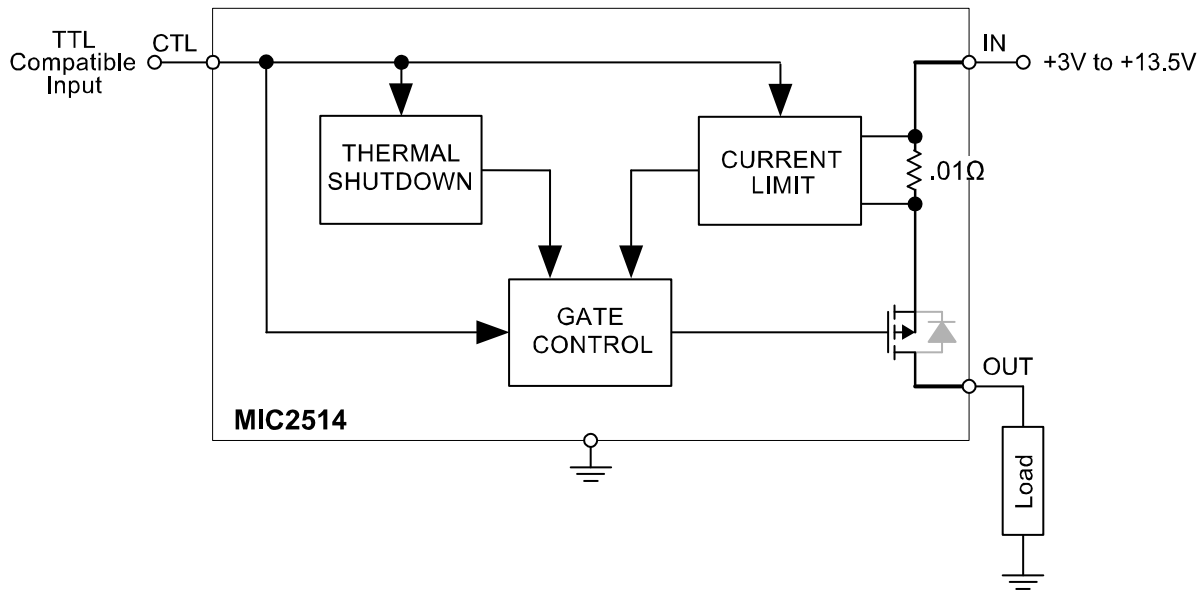

Functional Description

The MIC2514 is a non-inverting high-side switch. A logic-high control input turns on the output transistor, and a logic-low turns off the output transistor. Fault conditions turn off the output transistor.

Control Input

Applying a logic-high input to CTL (control input) activates the thermal shutdown and gate control circuits. If there are no fault conditions, the output MOSFET turns on.

Gate Control

The gate control circuit applies the supply voltage to the output MOSFET gate, turning it off, or forces the MOSFET gate below the supply voltage, turning it on, as determined by CTL and thermal shutdown.

Input and Output

IN (input) is the supply connection to the logic circuitry and the source of the output MOSFET. OUT (output) is the drain of the output MOSFET. In a typical circuit; current flows through the switch from IN to OUT toward the load.

The output MOSFET has an intrinsic body diode which will conduct if OUT is forced to a higher voltage than IN.

Thermal Shutdown

Thermal shutdown turns off the output MOSFET if the die temperature exceeds approximately 170°C. Thermal shut-down releases the output after the die temperature decreases 10°C.

Current Limit

The current limit is preset internally. The preset level prevents damage to the output MOSFET but allows a typical current of 1.9A through the output MOSFET for the MIC2514. This current limit is sufficient to protect the bond wire and the output device from instantaneous high current. Package thermal ratings and power dissipation should be considered when determining safe continuous operating current. Output current is monitored by sensing the voltage drop across the output MOSFET source metal resistance.

Package Information

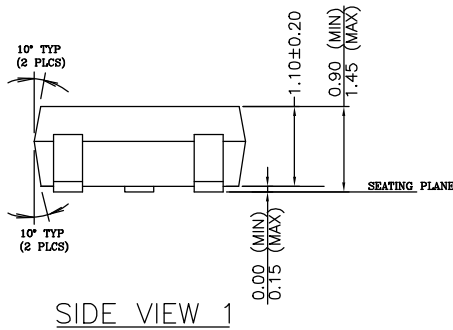
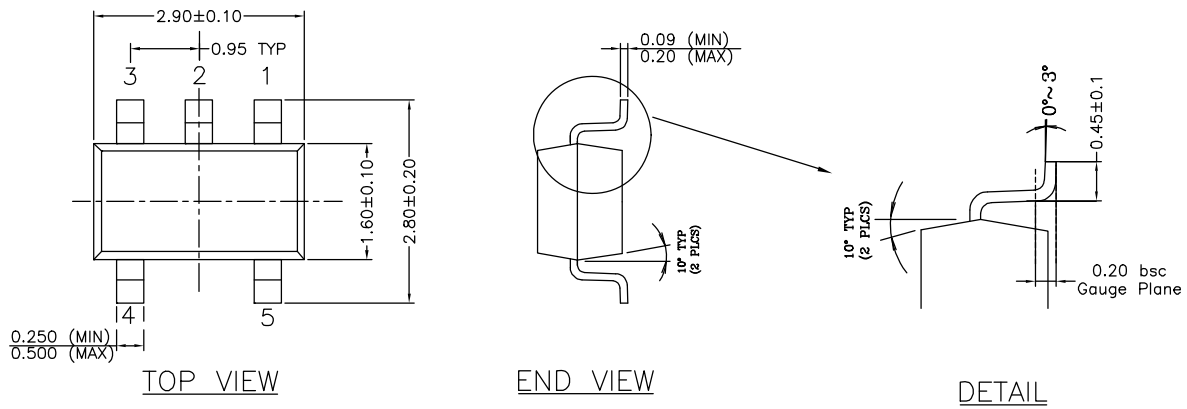

NOTE:
 1. PACKAGE OUTLINE EXCLUSIVE OF MOLD FLASH & BURR.
 2. PACKAGE OUTLINE INCLUSIVE OF SOLER PLATING.
 3. DIMENSION AND TOLERANCE PER ANSI Y14.5M, 1982.
 4. FOOT LENGTH MEASUREMENT BASED ON GAUGE PLANE METHOD.
 5. DIE FACES UP FOR MOLD, AND FACES DOWN FOR TRIM/FORM.
 6. ALL DIMENSIONS ARE IN MILLIMETERS.

5-Pin SOT-23 (M5)

MICREL, INC. 2180 FORTUNE DRIVE SAN JOSE, CA 95131 USA
 TEL +1 (408) 944-0800 FAX +1 (408) 474-1000 WEB <http://www.micrel.com>

The information furnished by Micrel in this data sheet is believed to be accurate and reliable. However, no responsibility is assumed by Micrel for its use. Micrel reserves the right to change circuitry and specifications at any time without notification to the customer.

Micrel Products are not designed or authorized for use as components in life support appliances, devices or systems where malfunction of a product can reasonably be expected to result in personal injury. Life support devices or systems are devices or systems that (a) are intended for surgical implant into the body or (b) support or sustain life, and whose failure to perform can be reasonably expected to result in a significant injury to the user. A Purchaser's use or sale of Micrel Products for use in life support appliances, devices or systems is a Purchaser's own risk and Purchaser agrees to fully indemnify Micrel for any damages resulting from such use or sale.

© 1997 Micrel, Incorporated.

Mouser Electronics

Authorized Distributor

Click to View Pricing, Inventory, Delivery & Lifecycle Information:

[Micrel:](#)

[MIC2514YM5 TR](#)

[Microchip:](#)

[MIC2514YM5-TR](#)