



PESDxS1UL series

Unidirectional ESD protection diodes

Rev. 3 — 25 October 2011

Product data sheet

1. Product profile

1.1 General description

Unidirectional ElectroStatic Discharge (ESD) protection diodes in a SOD882 leadless ultra small Surface Mounted Device (SMD) plastic package designed to protect one signal line from the damage caused by ESD and other transients.

1.2 Features and benefits

- Ultra small SMD plastic package
- ESD protection of one line
- Max. peak pulse power: $P_{PP} = 150 \text{ W}$
- Low clamping voltage: $V_{CL} = 20 \text{ V}$
- AEC-Q101 qualified
- Ultra low leakage current: $I_{RM} < 700 \text{ nA}$
- ESD protection up to 30 kV
- IEC 61000-4-2; level 4 (ESD)
- IEC 61000-4-5; (surge); I_{PP} up to 15 A

1.3 Applications

- Computers and peripherals
- Audio and video equipment
- Parallel ports
- Communication systems
- High-speed data lines

1.4 Quick reference data



Table 1. Quick reference data

| Symbol | Parameter | Conditions | Min | Typ | Max | Unit |
|-----------|--------------------------|--|-----|-----|-----|------|
| V_{RWM} | reverse standoff voltage | | | | | |
| | PESD3V3S1UL | | - | - | 3.3 | V |
| | PESD5V0S1UL | | - | - | 5.0 | V |
| | PESD12VS1UL | | - | - | 12 | V |
| | PESD15VS1UL | | - | - | 15 | V |
| | PESD24VS1UL | | - | - | 24 | V |
| C_d | diode capacitance | $f = 1 \text{ MHz}; V_R = 0 \text{ V}$ | | | | |
| | PESD3V3S1UL | | - | 207 | 300 | pF |
| | PESD5V0S1UL | | - | 152 | 200 | pF |
| | PESD12VS1UL | | - | 38 | 75 | pF |
| | PESD15VS1UL | | - | 32 | 70 | pF |
| | PESD24VS1UL | | - | 23 | 50 | pF |



2. Pinning information

Table 2. Pinning

| Pin | Description | Simplified outline | Graphic symbol |
|-----|-------------|---|---|
| 1 | cathode |  <p>Transparent top view</p> |  sym035 |
| 2 | anode | | |

[1] The marking bar indicates the cathode.

3. Ordering information

Table 3. Ordering information

| Type number | Package | | |
|-------------|---------|--|---------|
| | Name | Description | Version |
| PESD3V3S1UL | - | leadless ultra small plastic package; 2 terminals; body 1.0 × 0.6 × 0.5 mm | SOD882 |
| PESD5V0S1UL | | | |
| PESD12VS1UL | | | |
| PESD15VS1UL | | | |
| PESD24VS1UL | | | |

4. Marking

Table 4. Marking codes

| Type number | Marking code |
|-------------|--------------|
| PESD3V3S1UL | G1 |
| PESD5V0S1UL | G2 |
| PESD12VS1UL | G3 |
| PESD15VS1UL | G4 |
| PESD24VS1UL | G5 |

5. Limiting values

Table 5. Limiting values

In accordance with the Absolute Maximum Rating System (IEC 60134).

| Symbol | Parameter | Conditions | Min | Max | Unit |
|------------------|----------------------|--------------------------|-----|------|-------|
| P _{PP} | peak pulse power | t _p = 8/20 μs | [1] | - | 150 W |
| I _{PP} | peak pulse current | t _p = 8/20 μs | [1] | | |
| | PESD3V3S1UL | | - | 15 | A |
| | PESD5V0S1UL | | - | 15 | A |
| | PESD12VS1UL | | - | 5 | A |
| | PESD15VS1UL | | - | 5 | A |
| | PESD24VS1UL | | - | 3 | A |
| T _j | junction temperature | | - | 150 | °C |
| T _{amb} | ambient temperature | | -65 | +150 | °C |
| T _{stg} | storage temperature | | -65 | +150 | °C |

[1] Non-repetitive current pulse 8/20 μs exponential decay waveform according to IEC 61000-4-5.

Table 6. ESD maximum ratings

| Symbol | Parameter | Conditions | Min | Max | Unit |
|------------------|---------------------------------|--------------------------------------|-----|-----|------|
| V _{ESD} | electrostatic discharge voltage | IEC 61000-4-2 (contact discharge) | [1] | | |
| | PESD3V3S1UL | | - | 30 | kV |
| | PESD5V0S1UL | | - | 30 | kV |
| | PESD12VS1UL | | - | 30 | kV |
| | PESD15VS1UL | | - | 30 | kV |
| | PESD24VS1UL | | - | 23 | kV |
| | PESDxS1UL series | MIL-STD-883 (human body model) | - | 10 | kV |

[1] Device stressed with ten non-repetitive ESD pulses.

Table 7. ESD standards compliance

| Standard | Conditions |
|--|---------------------------------|
| IEC 61000-4-2; level 4 (ESD) | > 15 kV (air); > 8 kV (contact) |
| MIL-STD-883; class 3B (human body model) | > 8 kV |

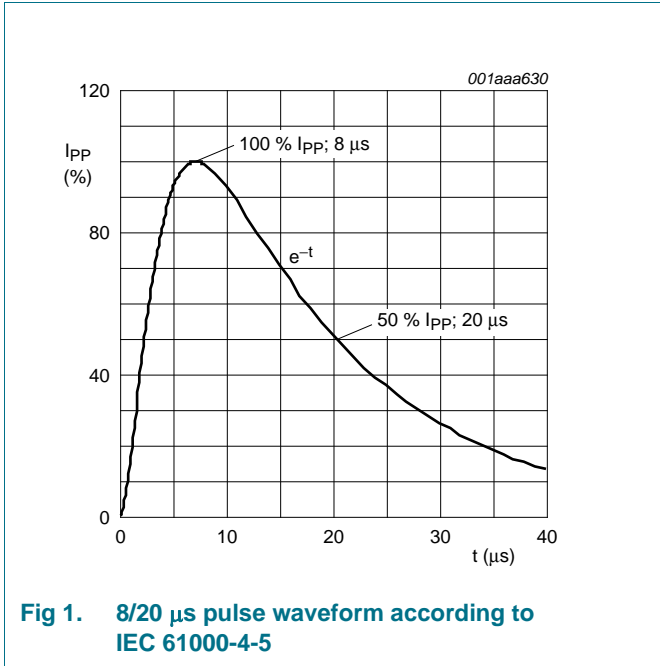

Fig 1. 8/20 μs pulse waveform according to IEC 61000-4-5

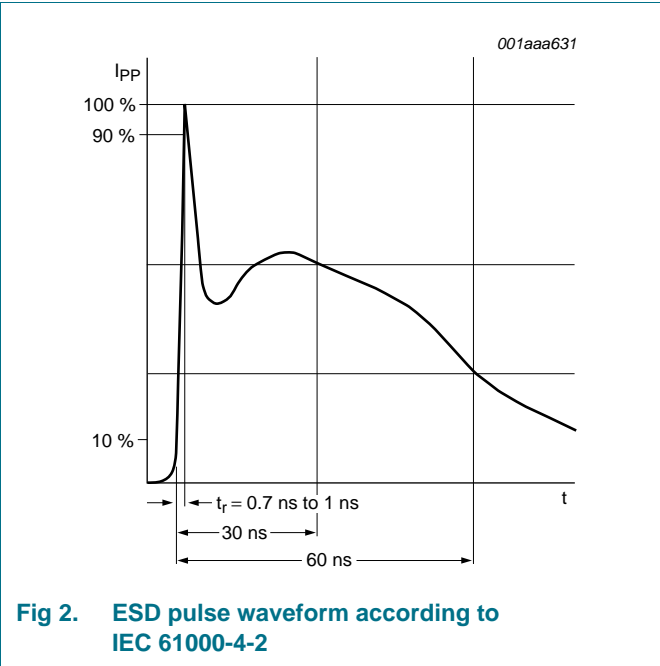

Fig 2. ESD pulse waveform according to IEC 61000-4-2

6. Characteristics

Table 8. Characteristics
T_{amb} = 25 °C unless otherwise specified

| Symbol | Parameter | Conditions | Min | Typ | Max | Unit |
|------------------|--------------------------|--------------------------|------|------|------|------|
| V _{RWM} | reverse standoff voltage | | | | | |
| | PESD3V3S1UL | | - | - | 3.3 | V |
| | PESD5V0S1UL | | - | - | 5.0 | V |
| | PESD12VS1UL | | - | - | 12 | V |
| | PESD15VS1UL | | - | - | 15 | V |
| PESD24VS1UL | | - | - | 24 | V | |
| I _{RM} | reverse leakage current | | | | | |
| | PESD3V3S1UL | V _{RWM} = 3.3 V | - | 0.7 | 2 | μA |
| | PESD5V0S1UL | V _{RWM} = 5.0 V | - | 0.1 | 1 | μA |
| | PESD12VS1UL | V _{RWM} = 12 V | - | < 1 | 50 | nA |
| | PESD15VS1UL | V _{RWM} = 15 V | - | < 1 | 50 | nA |
| PESD24VS1UL | V _{RWM} = 24 V | - | < 1 | 50 | nA | |
| V _{BR} | breakdown voltage | I _R = 5 mA | [1] | | | |
| | PESD3V3S1UL | | 5.2 | 5.6 | 6.0 | V |
| | PESD5V0S1UL | | 6.4 | 6.8 | 7.2 | V |
| | PESD12VS1UL | | 14.7 | 15.0 | 15.3 | V |
| | PESD15VS1UL | | 17.6 | 18.0 | 18.4 | V |
| PESD24VS1UL | | 26.5 | 27.0 | 27.5 | V | |

Table 8. Characteristics ...continued
T_{amb} = 25 °C unless otherwise specified

| Symbol | Parameter | Conditions | Min | Typ | Max | Unit |
|-----------------|-------------------|---------------------------------|-----|-----|-----|------|
| C _d | diode capacitance | f = 1 MHz; V _R = 0 V | | | | |
| | PESD3V3S1UL | | - | 207 | 300 | pF |
| | PESD5V0S1UL | | - | 152 | 200 | pF |
| | PESD12VS1UL | | - | 38 | 75 | pF |
| | PESD15VS1UL | | - | 32 | 70 | pF |
| | PESD24VS1UL | | - | 23 | 50 | pF |
| V _{CL} | clamping voltage | | [2] | | | |
| | PESD3V3S1UL | I _{PP} = 1 A | - | - | 8 | V |
| | | I _{PP} = 15 A | - | - | 20 | V |
| | PESD5V0S1UL | I _{PP} = 1 A | - | - | 9 | V |
| | | I _{PP} = 15 A | - | - | 20 | V |
| | PESD12VS1UL | I _{PP} = 1 A | - | - | 19 | V |
| | | I _{PP} = 5 A | - | - | 35 | V |
| | PESD15VS1UL | I _{PP} = 1 A | - | - | 23 | V |
| | | I _{PP} = 5 A | - | - | 40 | V |
| | PESD24VS1UL | I _{PP} = 1 A | - | - | 36 | V |
| | | I _{PP} = 3 A | - | - | 70 | V |
| | r _{dif} | differential resistance | | | | |
| PESD3V3S1UL | | I _R = 1 mA | - | - | 400 | Ω |
| PESD5V0S1UL | | I _R = 1 mA | - | - | 80 | Ω |
| PESD12VS1UL | | I _R = 1 mA | - | - | 200 | Ω |
| PESD15VS1UL | | I _R = 1 mA | - | - | 225 | Ω |
| PESD24VS1UL | | I _R = 0.5 mA | - | - | 300 | Ω |

[1] Pulse test: t_p ≤ 300 μs; duty cycle ≤ 0.02.

[2] Non-repetitive current pulse 8/20 μs exponential decay waveform according to IEC 61000-4-5.

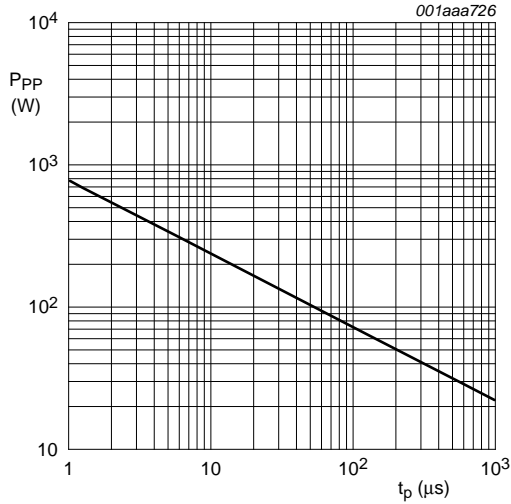

Fig 3. Peak pulse power as a function of exponential pulse duration; typical values

$T_{amb} = 25\text{ }^{\circ}\text{C}$

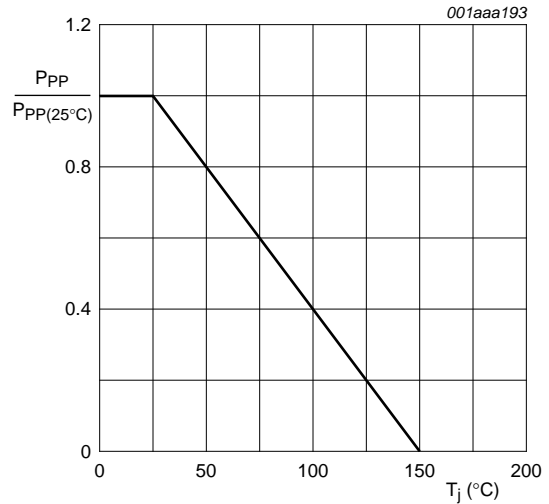

Fig 4. Relative variation of peak pulse power as a function of junction temperature; typical values

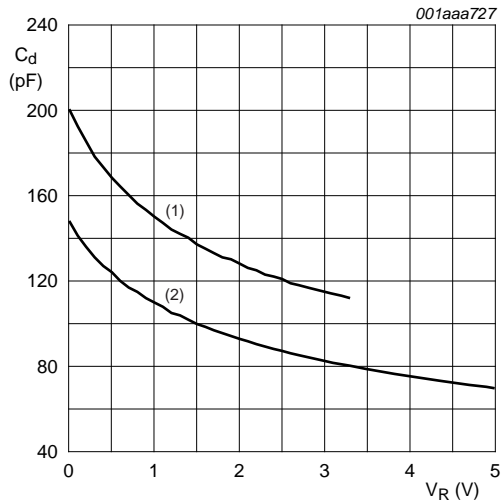

Fig 5. Diode capacitance as a function of reverse voltage; typical values

$f = 1\text{ MHz}; T_{amb} = 25\text{ }^{\circ}\text{C}$

- (1) PESD3V3S1UL; $V_{RWM} = 3.3\text{ V}$
- (2) PESD5V0S1UL; $V_{RWM} = 5.0\text{ V}$

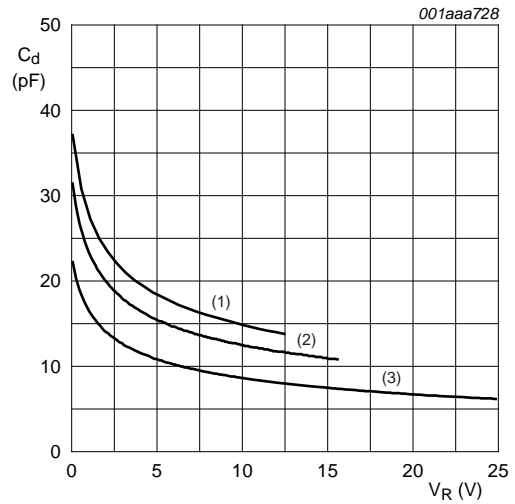
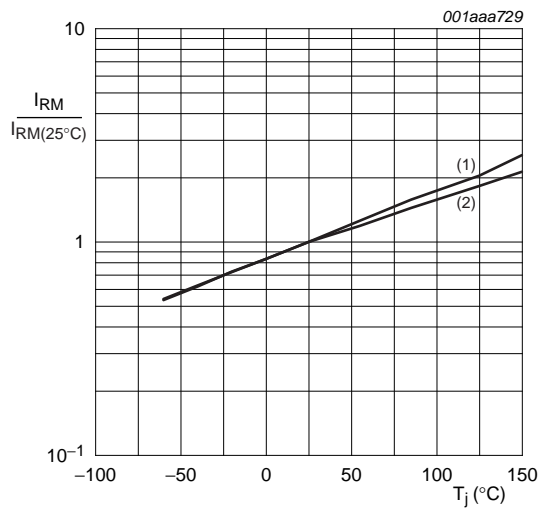

Fig 6. Diode capacitance as a function of reverse voltage; typical values

$f = 1\text{ MHz}; T_{amb} = 25\text{ }^{\circ}\text{C}$

- (1) PESD12VS1UL; $V_{RWM} = 12\text{ V}$
- (2) PESD15VS1UL; $V_{RWM} = 15\text{ V}$
- (3) PESD24VS1UL; $V_{RWM} = 24\text{ V}$



- (1) PESD3V3S1UL; $V_{RWM} = 3.3$ V
 - (2) PESD5V0S1UL; $V_{RWM} = 5.0$ V
- I_R is less than 15 nA at 150 °C for:
- PESD12VS1UL; $V_{RWM} = 12$ V
 - PESD15VS1UL; $V_{RWM} = 15$ V
 - PESD24VS1UL; $V_{RWM} = 24$ V

Fig 7. Relative variation of reverse leakage current as a function of junction temperature; typical values

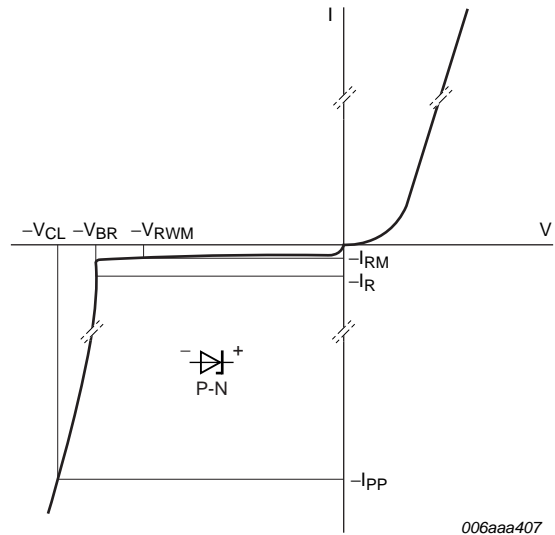
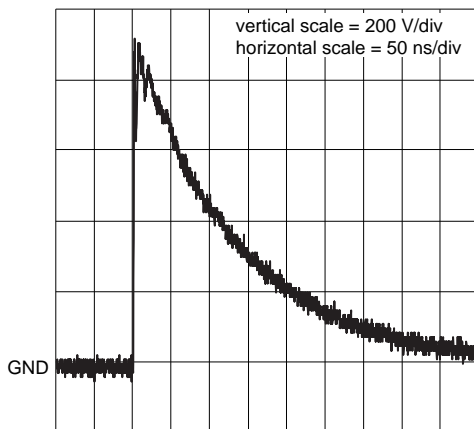
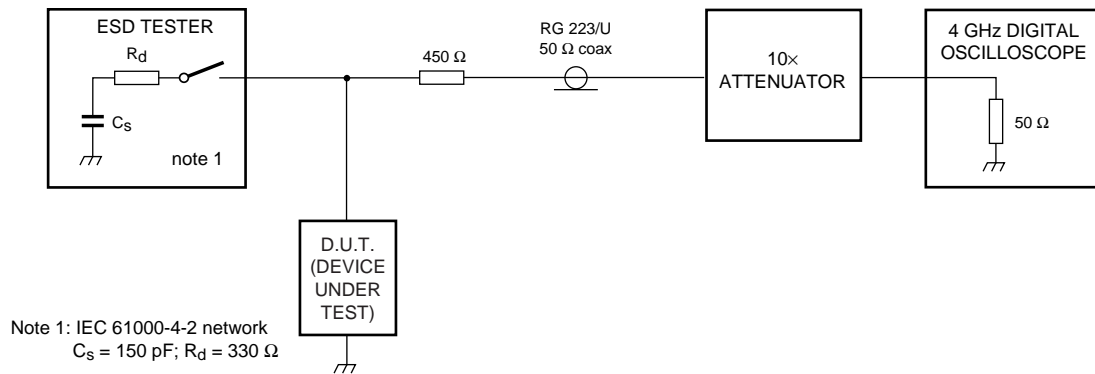
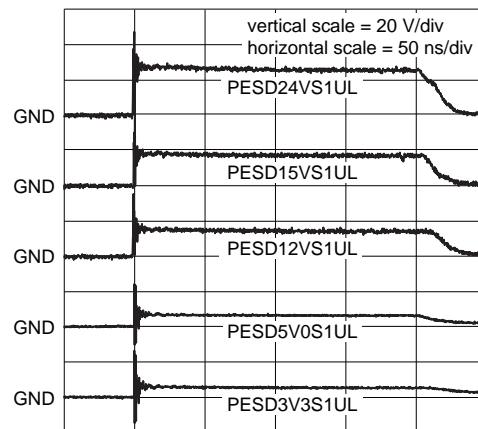

Fig 8. V-I characteristics for a unidirectional ESD protection diode



unclamped +1 kV ESD voltage waveform
 (IEC 61000-4-2 network)



clamped +1 kV ESD voltage waveform
 (IEC 61000-4-2 network)

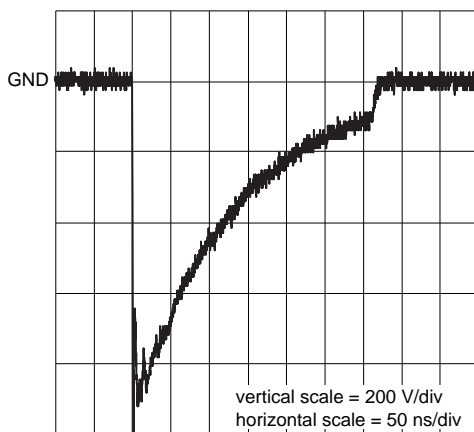

unclamped -1 kV ESD voltage waveform
 (IEC 61000-4-2 network)

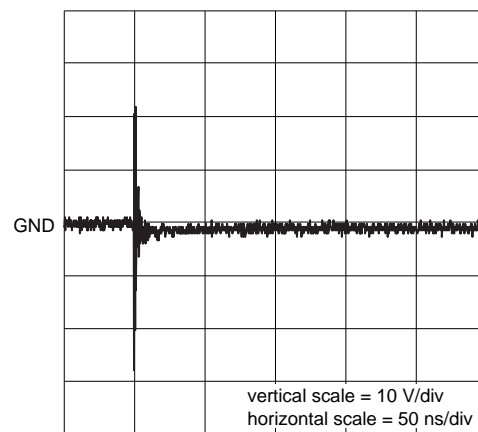

clamped -1 kV ESD voltage waveform
 (IEC 61000-4-2 network)

006aaa682

Fig 9. ESD clamping test setup and waveforms

7. Application information

The PESDxS1UL series is designed for protection of one unidirectional data line from the damage caused by ESD and surge pulses. The PESDxS1UL series may be used on lines where the signal polarities are either positive or negative with respect to ground. The PESDxS1UL series provides a surge capability of 150 W for an 8/20 μ s waveform.

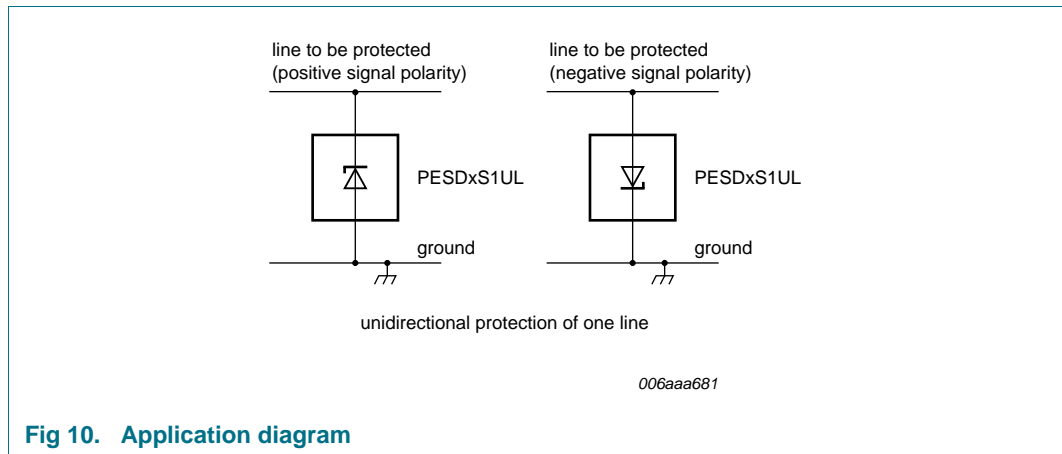

Fig 10. Application diagram

Circuit board layout and protection device placement

Circuit board layout is critical for the suppression of ESD, Electrical Fast Transient (EFT) and surge transients. The following guidelines are recommended:

1. Place the PESDxS1UL as close to the input terminal or connector as possible.
2. The path length between the PESDxS1UL and the protected line should be minimized.
3. Keep parallel signal paths to a minimum.
4. Avoid running protected conductors in parallel with unprotected conductors.
5. Minimize all Printed-Circuit Board (PCB) conductive loops including power and ground loops.
6. Minimize the length of the transient return path to ground.
7. Avoid using shared transient return paths to a common ground point.
8. Ground planes should be used whenever possible. For multilayer PCBs, use ground vias.

8. Test information

8.1 Quality information

This product has been qualified in accordance with the Automotive Electronics Council (AEC) standard *Q101 - Stress test qualification for discrete semiconductors*, and is suitable for use in automotive applications.

9. Package outline

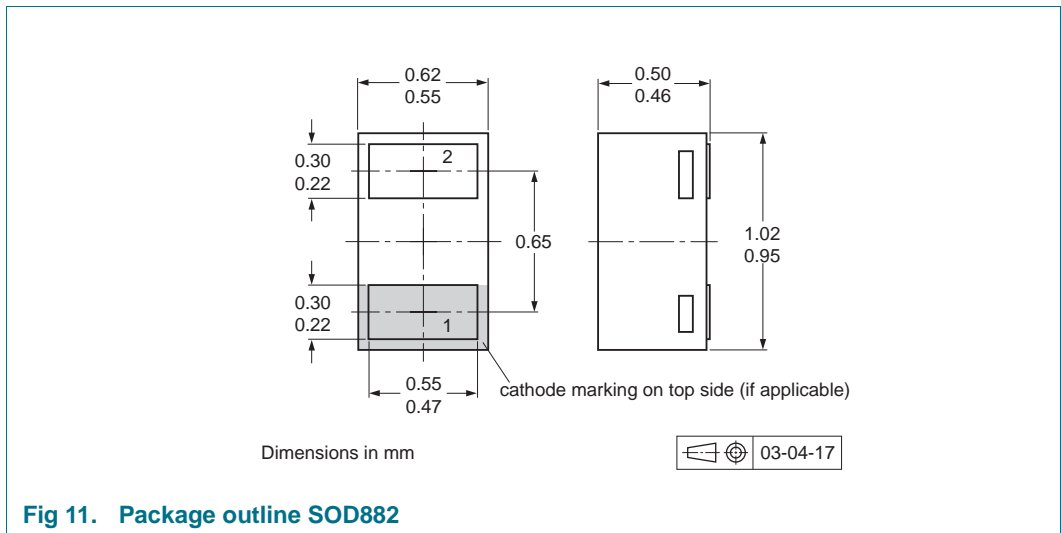

Fig 11. Package outline SOD882

10. Packing information

Table 9. Packing methods

The indicated -xxx are the last three digits of the 12NC ordering code.^[1]

| Type number | Package | Description | Packing quantity |
|-------------|---------|--------------------------------|------------------|
| | | | 10000 |
| PESD3V3S1UL | SOD882 | 4 mm pitch, 8 mm tape and reel | -315 |
| PESD5V0S1UL | | | |
| PESD12VS1UL | | | |
| PESD15VS1UL | | | |
| PESD24VS1UL | | | |

[1] For further information and the availability of packing methods, see [Section 14](#).

11. Soldering

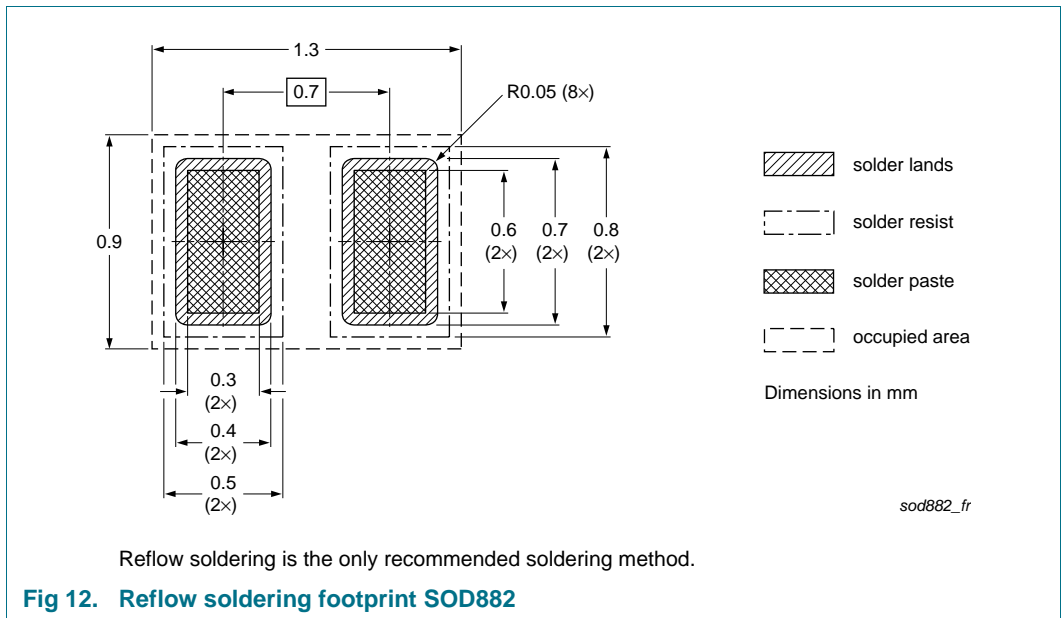

12. Revision history

Table 10. Revision history

| Document ID | Release date | Data sheet status | Change notice | Supersedes |
|-------------------|--------------|--|---------------|-------------------|
| PESDXS1UL_SER v.3 | 20111025 | Product data sheet | - | PESDXS1UL_SER v.2 |
| Modifications: | | <ul style="list-style-type: none"> • Section 1.2 "Features and benefits": updated • Table 7: updated • Table 8: added pulse conditions for breakdown voltage V_{BR} • Section 8 "Test information": added • Section 11 "Soldering": added • Section 13 "Legal information": updated | | |
| PESDXS1UL_SER v.2 | 20090820 | Product data sheet | - | PESDXS1UL_SER v.1 |
| PESDXS1UL_SER v.1 | 20060331 | Product data sheet | - | - |

13. Legal information

13.1 Data sheet status

| Document status ^{[1][2]} | Product status ^[3] | Definition |
|-----------------------------------|-------------------------------|---|
| Objective [short] data sheet | Development | This document contains data from the objective specification for product development. |
| Preliminary [short] data sheet | Qualification | This document contains data from the preliminary specification. |
| Product [short] data sheet | Production | This document contains the product specification. |

[1] Please consult the most recently issued document before initiating or completing a design.

[2] The term 'short data sheet' is explained in section "Definitions".

[3] The product status of device(s) described in this document may have changed since this document was published and may differ in case of multiple devices. The latest product status information is available on the Internet at URL <http://www.nxp.com>.

13.2 Definitions

Draft — The document is a draft version only. The content is still under internal review and subject to formal approval, which may result in modifications or additions. NXP Semiconductors does not give any representations or warranties as to the accuracy or completeness of information included herein and shall have no liability for the consequences of use of such information.

Short data sheet — A short data sheet is an extract from a full data sheet with the same product type number(s) and title. A short data sheet is intended for quick reference only and should not be relied upon to contain detailed and full information. For detailed and full information see the relevant full data sheet, which is available on request via the local NXP Semiconductors sales office. In case of any inconsistency or conflict with the short data sheet, the full data sheet shall prevail.

Product specification — The information and data provided in a Product data sheet shall define the specification of the product as agreed between NXP Semiconductors and its customer, unless NXP Semiconductors and customer have explicitly agreed otherwise in writing. In no event however, shall an agreement be valid in which the NXP Semiconductors product is deemed to offer functions and qualities beyond those described in the Product data sheet.

13.3 Disclaimers

Limited warranty and liability — Information in this document is believed to be accurate and reliable. However, NXP Semiconductors does not give any representations or warranties, expressed or implied, as to the accuracy or completeness of such information and shall have no liability for the consequences of use of such information.

In no event shall NXP Semiconductors be liable for any indirect, incidental, punitive, special or consequential damages (including - without limitation - lost profits, lost savings, business interruption, costs related to the removal or replacement of any products or rework charges) whether or not such damages are based on tort (including negligence), warranty, breach of contract or any other legal theory.

Notwithstanding any damages that customer might incur for any reason whatsoever, NXP Semiconductors' aggregate and cumulative liability towards customer for the products described herein shall be limited in accordance with the *Terms and conditions of commercial sale* of NXP Semiconductors.

Right to make changes — NXP Semiconductors reserves the right to make changes to information published in this document, including without limitation specifications and product descriptions, at any time and without notice. This document supersedes and replaces all information supplied prior to the publication hereof.

Suitability for use — NXP Semiconductors products are not designed, authorized or warranted to be suitable for use in life support, life-critical or safety-critical systems or equipment, nor in applications where failure or

malfunction of an NXP Semiconductors product can reasonably be expected to result in personal injury, death or severe property or environmental damage. NXP Semiconductors accepts no liability for inclusion and/or use of NXP Semiconductors products in such equipment or applications and therefore such inclusion and/or use is at the customer's own risk.

Applications — Applications that are described herein for any of these products are for illustrative purposes only. NXP Semiconductors makes no representation or warranty that such applications will be suitable for the specified use without further testing or modification.

Customers are responsible for the design and operation of their applications and products using NXP Semiconductors products, and NXP Semiconductors accepts no liability for any assistance with applications or customer product design. It is customer's sole responsibility to determine whether the NXP Semiconductors product is suitable and fit for the customer's applications and products planned, as well as for the planned application and use of customer's third party customer(s). Customers should provide appropriate design and operating safeguards to minimize the risks associated with their applications and products.

NXP Semiconductors does not accept any liability related to any default, damage, costs or problem which is based on any weakness or default in the customer's applications or products, or the application or use by customer's third party customer(s). Customer is responsible for doing all necessary testing for the customer's applications and products using NXP Semiconductors products in order to avoid a default of the applications and the products or of the application or use by customer's third party customer(s). NXP does not accept any liability in this respect.

Limiting values — Stress above one or more limiting values (as defined in the Absolute Maximum Ratings System of IEC 60134) will cause permanent damage to the device. Limiting values are stress ratings only and (proper) operation of the device at these or any other conditions above those given in the Recommended operating conditions section (if present) or the Characteristics sections of this document is not warranted. Constant or repeated exposure to limiting values will permanently and irreversibly affect the quality and reliability of the device.

Terms and conditions of commercial sale — NXP Semiconductors products are sold subject to the general terms and conditions of commercial sale, as published at <http://www.nxp.com/profile/terms>, unless otherwise agreed in a valid written individual agreement. In case an individual agreement is concluded only the terms and conditions of the respective agreement shall apply. NXP Semiconductors hereby expressly objects to applying the customer's general terms and conditions with regard to the purchase of NXP Semiconductors products by customer.

No offer to sell or license — Nothing in this document may be interpreted or construed as an offer to sell products that is open for acceptance or the grant, conveyance or implication of any license under any copyrights, patents or other industrial or intellectual property rights.

Export control — This document as well as the item(s) described herein may be subject to export control regulations. Export might require a prior authorization from competent authorities.

Quick reference data — The Quick reference data is an extract of the product data given in the Limiting values and Characteristics sections of this document, and as such is not complete, exhaustive or legally binding.

13.4 Trademarks

Notice: All referenced brands, product names, service names and trademarks are the property of their respective owners.

14. Contact information

For more information, please visit: <http://www.nxp.com>

For sales office addresses, please send an email to: salesaddresses@nxp.com

15. Contents

| | | |
|-----------|--------------------------------------|-----------|
| 1 | Product profile | 1 |
| 1.1 | General description | 1 |
| 1.2 | Features and benefits | 1 |
| 1.3 | Applications | 1 |
| 1.4 | Quick reference data | 1 |
| 2 | Pinning information | 2 |
| 3 | Ordering information | 2 |
| 4 | Marking | 2 |
| 5 | Limiting values | 3 |
| 6 | Characteristics | 4 |
| 7 | Application information | 9 |
| 8 | Test information | 9 |
| 8.1 | Quality information | 9 |
| 9 | Package outline | 10 |
| 10 | Packing information | 10 |
| 11 | Soldering | 11 |
| 12 | Revision history | 12 |
| 13 | Legal information | 13 |
| 13.1 | Data sheet status | 13 |
| 13.2 | Definitions | 13 |
| 13.3 | Disclaimers | 13 |
| 13.4 | Trademarks | 14 |
| 14 | Contact information | 14 |
| 15 | Contents | 15 |

Please be aware that important notices concerning this document and the product(s) described herein, have been included in section 'Legal information'.

© NXP B.V. 2011.

All rights reserved.

For more information, please visit: <http://www.nxp.com>

For sales office addresses, please send an email to: salesaddresses@nxp.com

Date of release: 25 October 2011

Document identifier: PESDXS1UL_SER

Mouser Electronics

Authorized Distributor

Click to View Pricing, Inventory, Delivery & Lifecycle Information:

[NXP:](#)

[PESD12VS1UL,315](#) [PESD15VS1UL,315](#) [PESD24VS1UL,315](#) [PESD3V3S1UL,315](#) [PESD5V0S1UL,315](#)