



2SC6082

Bipolar Transistor 50V, 15A, Low VCE (sat) NPN TO-220F-3SG

ON Semiconductor®

<http://onsemi.com>

Applications

- High-speed switching applications (switching regulator, driver circuit)

Features

- Adoption of MBIT process
- Low collector-to-emitter saturation voltage
- Large current capacitance
- High-speed switching

Specifications

Absolute Maximum Ratings at Ta=25°C

Parameter	Symbol	Conditions	Ratings	Unit
Collector-to-Base Voltage	VCBO		60	V
Collector-to-Emitter Voltage	VCES		60	V
	VCEO		50	V
Emitter-to-Base Voltage	VEBO		6	V
Collector Current	IC		15	A
Collector Current (Pulse)	ICP	PW≤10μs, duty cycle≤1%	20	A
Base Current	IB		3	A
Collector Dissipation	PC		2	W
		Tc=25°C	23	W
Junction Temperature	TJ		150	°C
Storage Temperature	Tstg		-55 to +150	°C

Stresses exceeding Maximum Ratings may damage the device. Maximum Ratings are stress ratings only. Functional operation above the Recommended Operating Conditions is not implied. Extended exposure to stresses above the Recommended Operating Conditions may affect device reliability.

Package Dimensions

unit : mm (typ)

7529-002

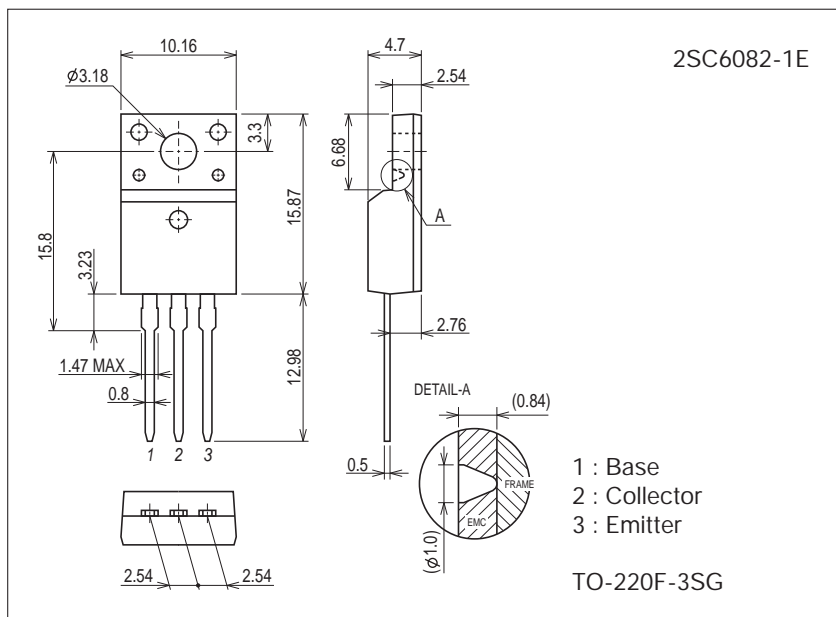

Product & Package Information

- Package : TO-220F-3SG
- JEITA, JEDEC : SC-67
- Minimum Packing Quantity : 50 pcs./magazine

Marking

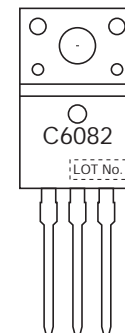

Electrical Connection

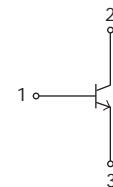

2SC6082

Electrical Characteristics at Ta=25°C

Parameter	Symbol	Conditions	Ratings			Unit
			min	typ	max	
Collector Cutoff Current	I_{CBO}	$V_{CB}=40V, I_E=0A$			10	μA
Emitter Cutoff Current	I_{EBO}	$V_{EB}=4V, I_C=0A$			10	μA
DC Current Gain	h_{FE1}	$V_{CE}=2V, I_C=330mA$	200		560	
	h_{FE2}	$V_{CE}=2V, I_C=10A$	50			
Gain-Bandwidth Product	f_T	$V_{CE}=10V, I_C=2A$		195		MHz
Output Capacitance	C_{ob}	$V_{CB}=10V, f=1MHz$		85		pF
Collector-to-Emitter Saturation Voltage	$V_{CE(sat)}$	$I_C=7.5A, I_B=375mA$		200	400	mV
Base-to-Emitter Saturation Voltage	$V_{BE(sat)}$	$I_C=7.5A, I_B=375mA$			1.2	V
Collector-to-Base Breakdown Voltage	$V_{(BR)CBO}$	$I_C=100\mu A, I_E=0A$	60			V
Collector-to-Emitter Breakdown Voltage	$V_{(BR)CES}$	$I_C=100\mu A, R_{BE}=0\Omega$	60			V
	$V_{(BR)CEO}$	$I_C=1mA, R_{BE}=\infty$	50			V
Emitter-to-Base Breakdown Voltage	$V_{(BR)EBO}$	$I_E=100\mu A, I_C=0A$	6			V
Turn-On Time	t_{on}	See specified Test Circuit		52		ns
Storage Time	t_{stg}			560		ns
Fall Time	t_f			37		ns

Switching Time Test Circuit

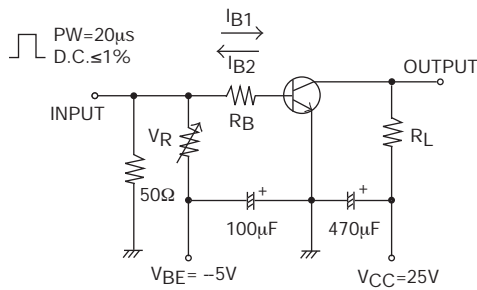

$$I_C = 20I_{B1} = -20I_{B2} = 5A$$

Ordering Information

Device	Package	Shipping	memo
2SC6082-1E	TO-220F-3SG	50pcs./magazine	Pb Free

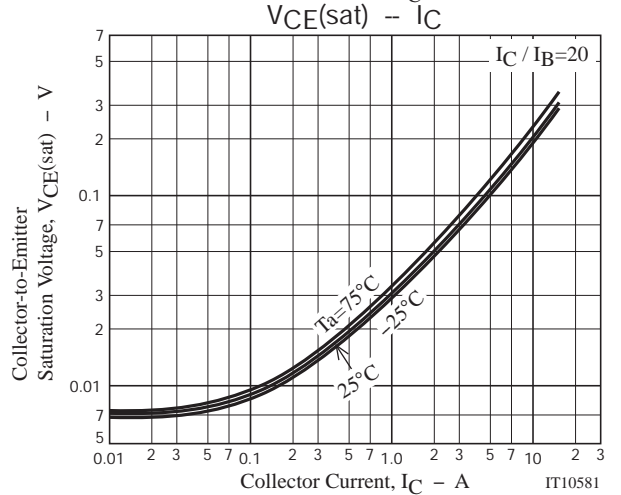
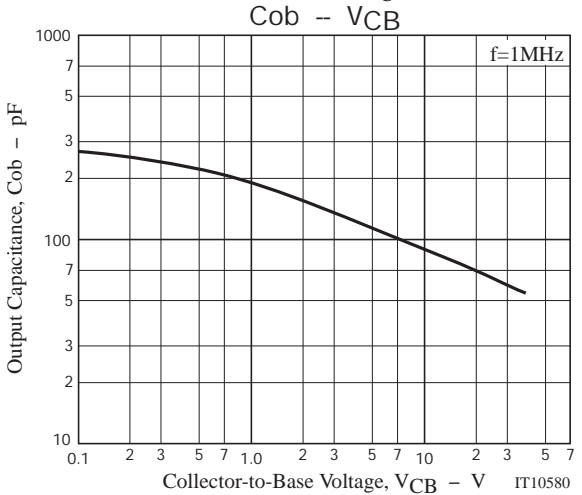
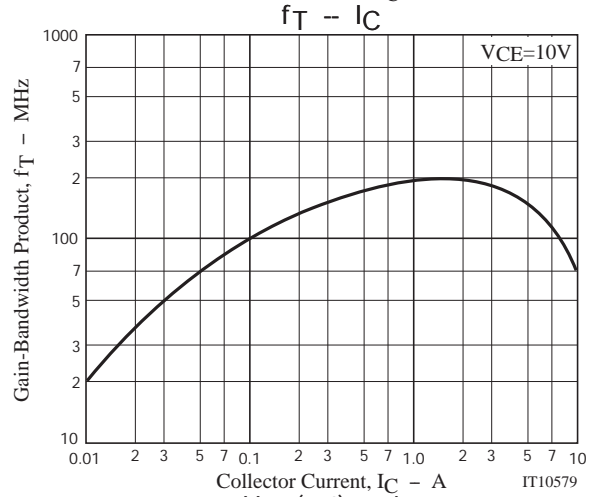
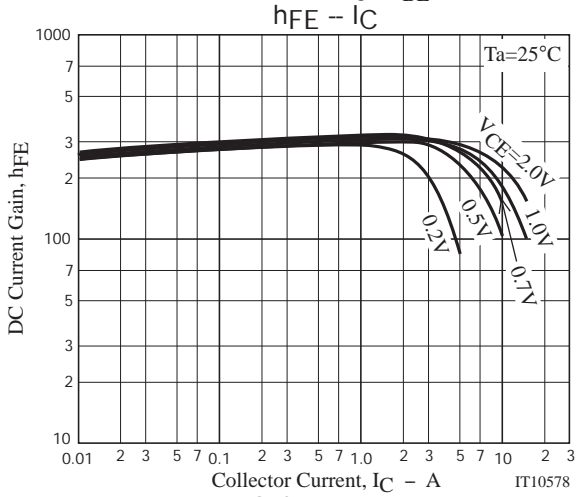
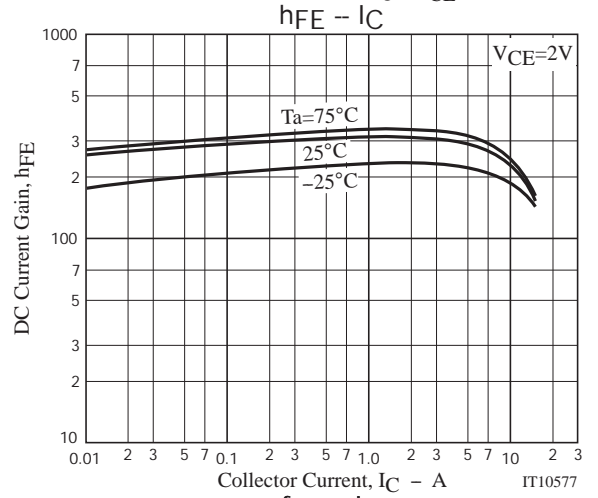
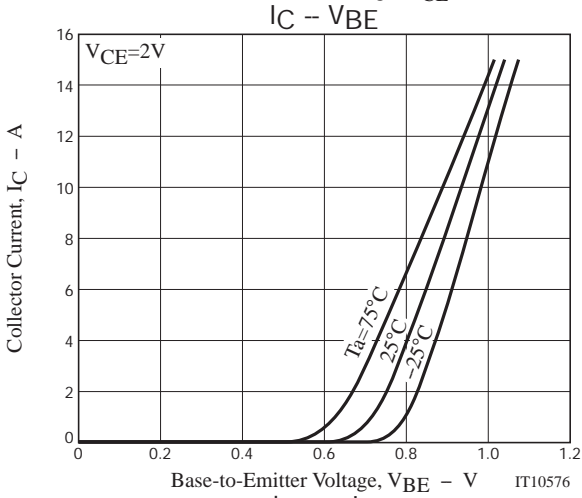
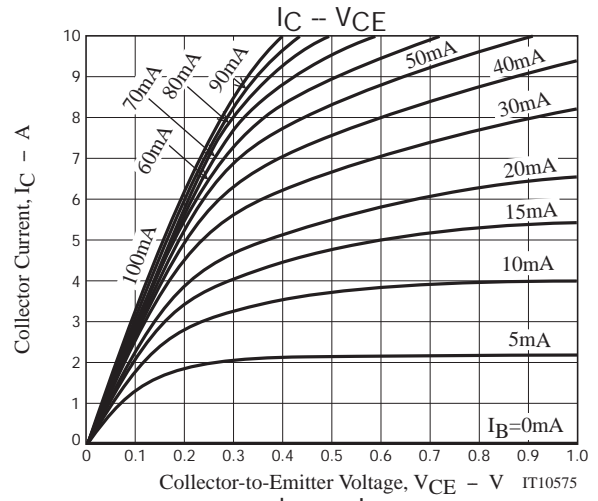
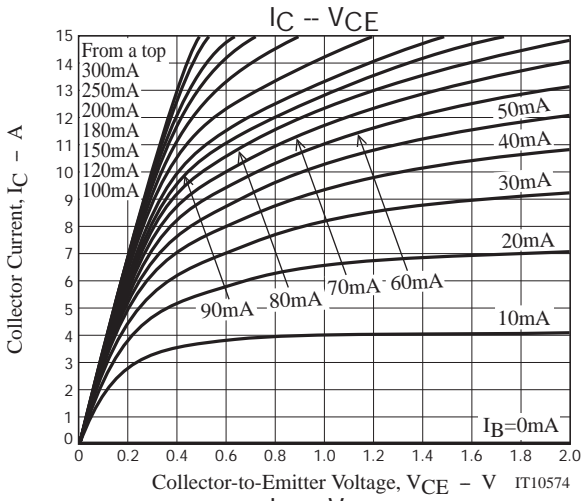

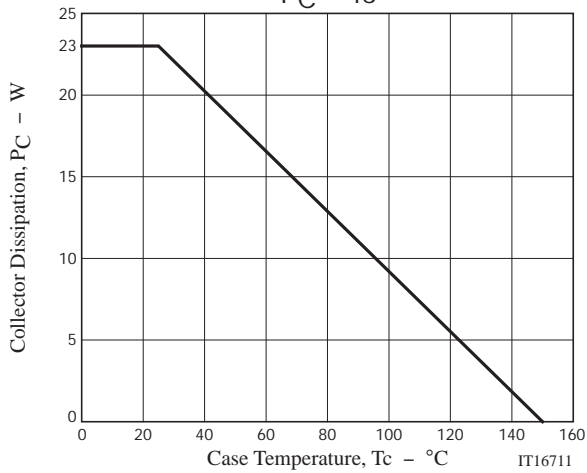
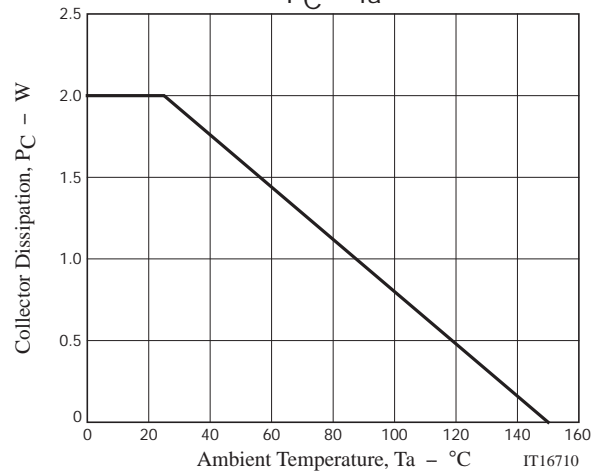
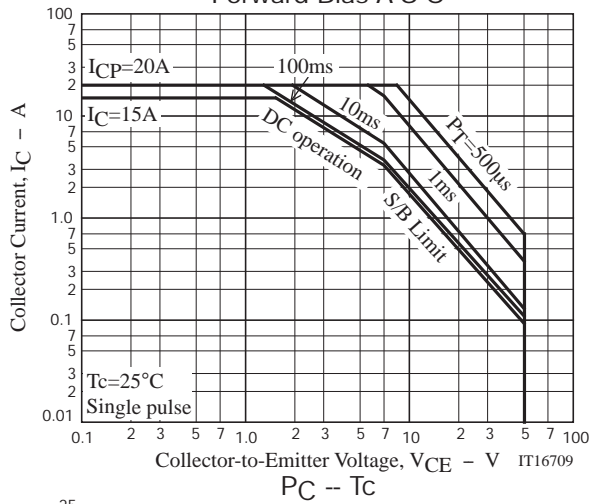
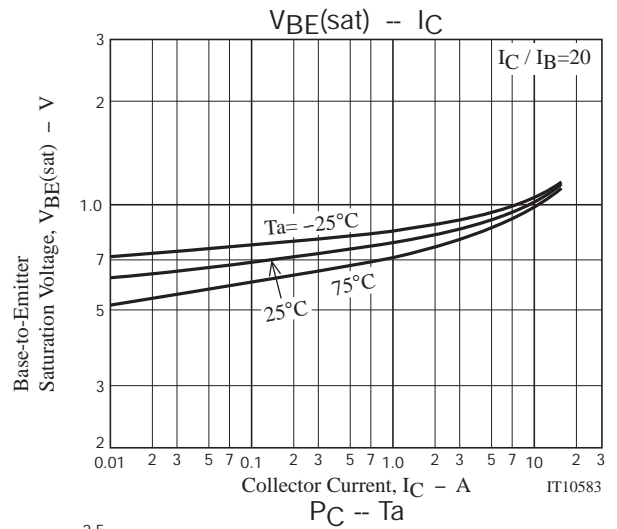
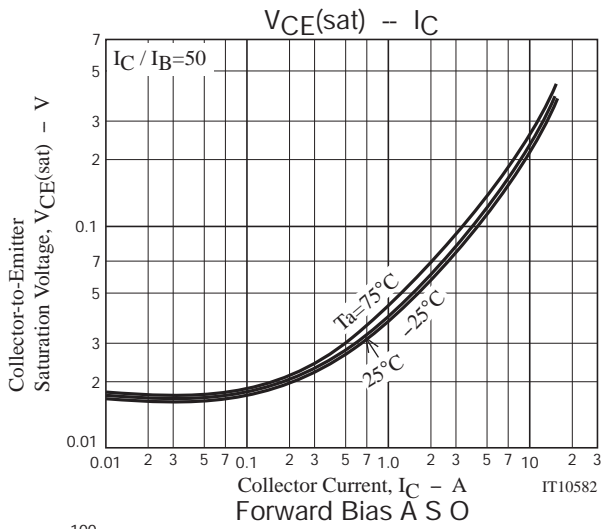

Magazine Specification

2SC6082-1E

1. Packing Format

Package Name	Magazine Name	Maximum Number of devices contained (pcs)			Packing format	
		Magazine	Inner box	Outer box	Inner BOX	Outer BOX
TO-220F-3SG	TO-220F	50	1,000	4,000	SPD-0V0001 20 magazines contained Dimensions:mm (external) 568×150×55	SPT-081029 4 inner boxes contained Dimensions:mm (external) 590×225×178

2. Magazine dimensions

(unit:mm)

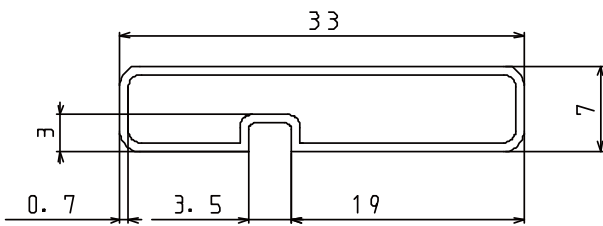

Tolerance=±0.3mm
 Thickness=0.7±0.2mm
 Length =532.5±2mm
 Material =PVC (Antistatic treatment)

3. Storage method to magazine

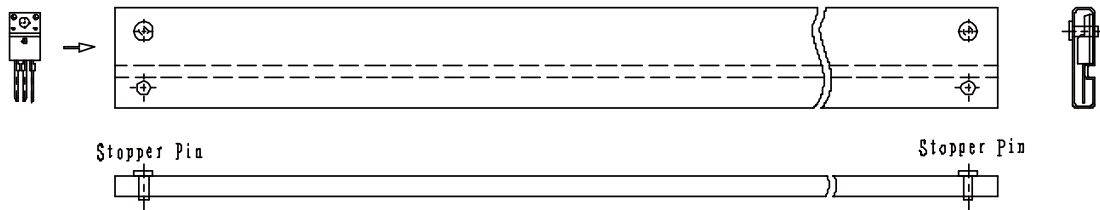

4. Inner box label (unit:mm)

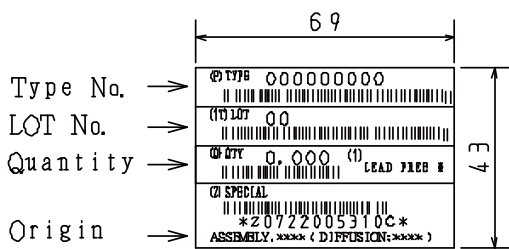

5. Outer box label (unit:mm)

It is a label at the time of factory shipments.
 The form of a label may change in physical
 distribution process.

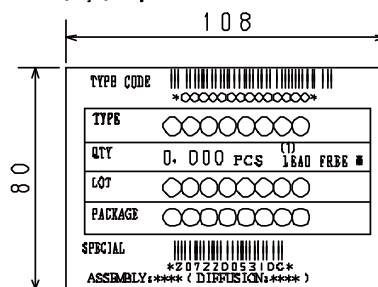

NOTE (1)

The LEAD FREE * description shows that the surface treatment of the terminal is lead free.

Label	JEITA Phase
LEAD FREE 3	JEITA Phase 3A

Outline Drawing

2SC6082-1E

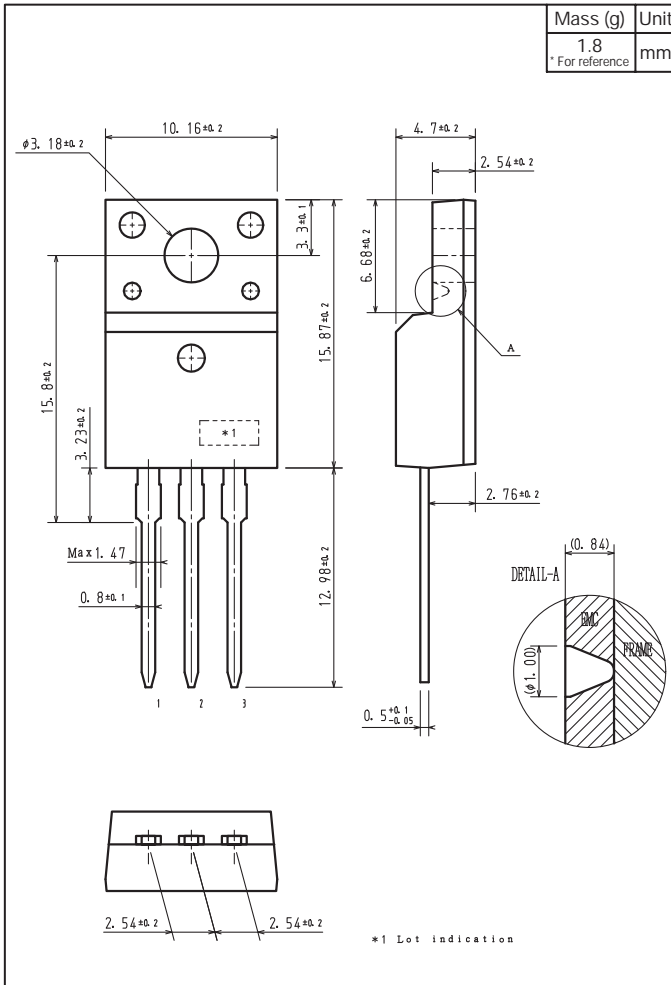

ON Semiconductor and the ON logo are registered trademarks of Semiconductor Components Industries, LLC (SCILLC). SCILLC owns the rights to a number of patents, trademarks, copyrights, trade secrets, and other intellectual property. A listing of SCILLC's product/patent coverage may be accessed at www.onsemi.com/site/pdf/Patent-Marking.pdf. SCILLC reserves the right to make changes without further notice to any products herein. SCILLC makes no warranty, representation or guarantee regarding the suitability of its products for any particular purpose, nor does SCILLC assume any liability arising out of the application or use of any product or circuit, and specifically disclaims any and all liability, including without limitation special, consequential or incidental damages. "Typical" parameters which may be provided in SCILLC data sheets and/or specifications can and do vary in different applications and actual performance may vary over time. All operating parameters, including "Typicals" must be validated for each customer application by customer's technical experts. SCILLC does not convey any license under its patent rights nor the rights of others. SCILLC products are not designed, intended, or authorized for use as components in systems intended for surgical implant into the body, or other applications intended to support or sustain life, or for any other application in which the failure of the SCILLC product could create a situation where personal injury or death may occur. Should Buyer purchase or use SCILLC products for any such unintended or unauthorized application, Buyer shall indemnify and hold SCILLC and its officers, employees, subsidiaries, affiliates, and distributors harmless against all claims, costs, damages, and expenses, and reasonable attorney fees arising out of, directly or indirectly, any claim of personal injury or death associated with such unintended or unauthorized use, even if such claim alleges that SCILLC was negligent regarding the design or manufacture of the part. SCILLC is an Equal Opportunity/Affirmative Action Employer. This literature is subject to all applicable copyright laws and is not for resale in any manner.

Mouser Electronics

Authorized Distributor

Click to View Pricing, Inventory, Delivery & Lifecycle Information:

[ON Semiconductor:](#)

[2SC6082](#) [2SC6082-1E](#)