

# MCR310 Series

Preferred Device

## Silicon Controlled Rectifiers

### Reverse Blocking Triode Thyristors

Designed for industrial and consumer applications such as temperature, light and speed control; process and remote controls; warning systems; capacitive discharge circuits and MPU interface.

- Center Gate Geometry for Uniform Current Density
- All Diffused and Glass-Passivated Junctions for Parameter Uniformity and Stability
- Small, Rugged, Thermowatt Construction for Low Thermal Resistance, High Heat Dissipation and Durability
- Low Trigger Currents, 200  $\mu$ A Maximum for Direct Driving from Integrated Circuits
- Pb-Free Packages are Available

#### MAXIMUM RATINGS ( $T_J = 25^\circ\text{C}$ unless otherwise noted.)

Rating	Symbol	Value	Unit
Peak Repetitive Forward and Reverse Blocking Voltage <sup>(1)</sup> ( $T_J = -40$ to $110^\circ\text{C}$ ) (1/2 Sine Wave, $R_{GK} = 1 \text{ k}\Omega$ ) MCR310-6 MCR310-8 MCR310-10	$V_{DRM}$ or $V_{RRM}$	400 600 800	Volts
On-State RMS Current ( $T_C = 75^\circ\text{C}$ )	$I_{T(RMS)}$	10	Amps
Peak Non-repetitive Surge Current (1/2 Cycle, 60 Hz, $T_J = -40$ to $110^\circ\text{C}$ )	$I_{TSM}$	100	Amps
Circuit Fusing ( $t = 8.3 \text{ ms}$ )	$I^2t$	40	$\text{A}^2\text{s}$
Peak Gate Voltage ( $t \leq 10 \mu\text{s}$ )	$V_{GM}$	$\pm 5$	Volts
Peak Gate Current ( $t \leq 10 \mu\text{s}$ )	$I_{GM}$	1	Amp
Peak Gate Power ( $t \leq 10 \mu\text{s}$ )	$P_{GM}$	5	Watts
Average Gate Power	$P_{G(AV)}$	0.75	Watt
Operating Junction Temperature Range	$T_J$	-40 to +110	$^\circ\text{C}$
Storage Temperature Range	$T_{stg}$	-40 to +150	$^\circ\text{C}$
Mounting Torque	-	8	in.-lb.

#### THERMAL CHARACTERISTICS

Characteristic	Symbol	Max	Unit
Thermal Resistance, Junction to Case	$R_{\theta JC}$	2.2	$^\circ\text{C}/\text{W}$
Thermal Resistance, Junction to Ambient	$R_{\theta JA}$	60	$^\circ\text{C}/\text{W}$

Stresses exceeding Maximum Ratings may damage the device. Maximum Ratings are stress ratings only. Functional operation above the Recommended Operating Conditions is not implied. Extended exposure to stresses above the Recommended Operating Conditions may affect device reliability.

(1)  $V_{DRM}$  and  $V_{RRM}$  for all types can be applied on a continuous basis. Ratings apply for zero or negative gate voltage; however, positive gate voltage shall not be applied concurrent with negative potential on the anode. Blocking voltages shall not be tested with a constant current source such that the voltage ratings of the devices are exceeded.



ON Semiconductor®

<http://onsemi.com>

SCRs  
10 AMPERES RMS  
400 thru 800 VOLTS

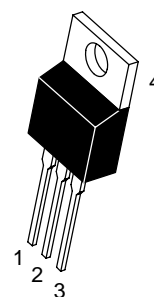

TO-220AB  
CASE 221A  
STYLE 3

- x = 6, 8 or 10
- A = Assembly Location
- Y = Year
- WW = Work Week
- G = Pb-Free Package

#### MARKING DIAGRAM

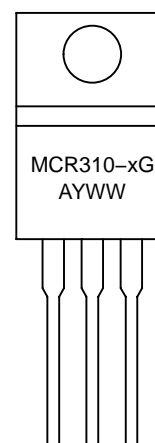

#### ORDERING INFORMATION

Device	Package	Shipping
MCR310-6	TO220AB	500/Box
MCR310-6G	TO220AB (Pb-Free)	500/Box
MCR310-8	TO220AB	500/Box
MCR310-8G	TO220AB (Pb-Free)	500/Box
MCR310-10	TO220AB	500/Box
MCR310-10G	TO220AB (Pb-Free)	500/Box

Preferred devices are recommended choices for future use and best overall value.

# MCR310 Series

## ELECTRICAL CHARACTERISTICS ( $T_C = 25^\circ\text{C}$ , $R_{GK} = 1\text{ k}\Omega$ unless otherwise noted)

Characteristic		Symbol	Min	Typ	Max	Unit
Peak Forward Blocking Current <sup>(1)</sup> ( $T_J = 110^\circ\text{C}$ , $V_D = \text{Rated } V_{DRM}$ )	$T_C = 110^\circ\text{C}$	$I_{DRM}$	—	—	500	$\mu\text{A}$
	$T_C = 25^\circ\text{C}$		—	—	10	$\mu\text{A}$
Peak Reverse Blocking Current <sup>(1)</sup> ( $T_J = 110^\circ\text{C}$ , $V_R = \text{Rated } V_{RRM}$ )	$T_C = 110^\circ\text{C}$	$I_{RRM}$	—	—	500	$\mu\text{A}$
	$T_C = 25^\circ\text{C}$		—	—	10	$\mu\text{A}$
On-State Voltage ( $I_{TM} = 20\text{ A Peak}$ , Pulse Width $\leq 1\text{ ms}$ , Duty Cycle $\leq 2\%$ )		$V_{TM}$	—	1.7	2.2	Volts
Gate Trigger Current, Continuous dc <sup>(2)</sup> ( $V_D = 12\text{ V}$ , $R_L = 100\ \Omega$ )		$I_{GT}$	—	30	200	$\mu\text{A}$
Gate Trigger Voltage, Continuous dc ( $V_D = 12\text{ V}$ , $R_L = 100\ \Omega$ ) ( $V_D = \text{Rated } V_{DRM}$ , $R_L = 10\text{ k}\Omega$ , $T_J = 110^\circ\text{C}$ )		$V_{GT}$	—	0.5	1.5	Volts
			0.1	—	—	
Holding Current ( $V_D = 12\text{ V}$ , $I_{TM} = 100\text{ mA}$ )		$I_H$	—	—	6	mA
Critical Rate of Rise of Forward Blocking Voltage ( $V_D = \text{Rated } V_{DRM}$ , $T_J = 110^\circ\text{C}$ , Exponential Waveform)		dv/dt	—	10	—	V/ $\mu\text{s}$
Gate Controlled Turn-On Time ( $V_D = \text{Rated } V_{DRM}$ , $I_{TM} = 20\text{ A}$ , $I_G = 2\text{ mA}$ )		$t_{gt}$	—	1	—	$\mu\text{s}$

1. Ratings apply for negative gate voltage or  $R_{GK} = 1\text{ k}\Omega$ . Devices shall not have a positive gate voltage concurrently with a negative voltage on the anode. Devices should not be tested with a constant current source for forward and reverse blocking capability such that the voltage applied exceeds the rated blocking voltage.
2. Does not include  $R_{GK}$  current.

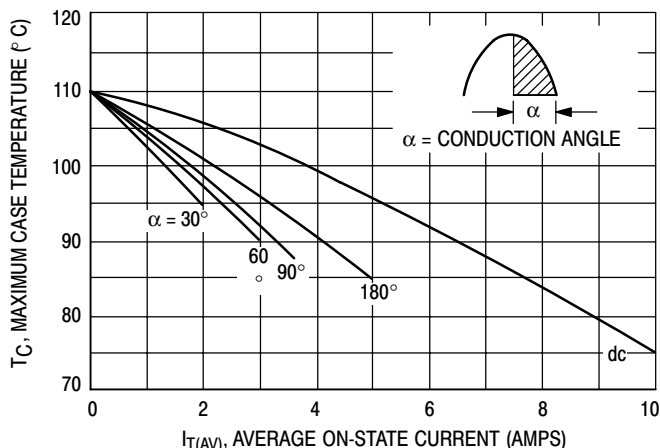

Figure 1. Average Current Derating

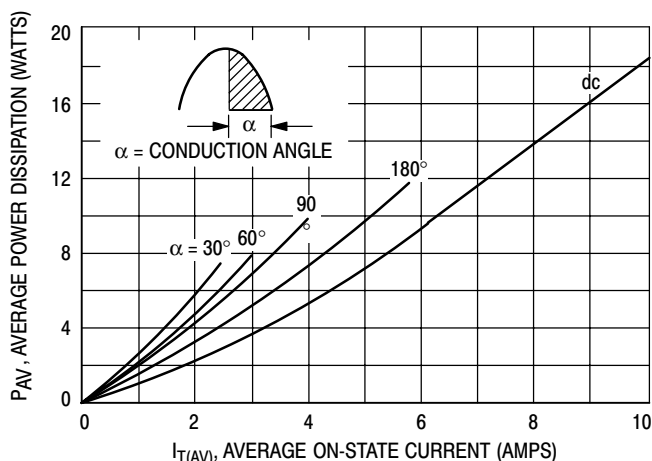

Figure 2. On-State Power Dissipation

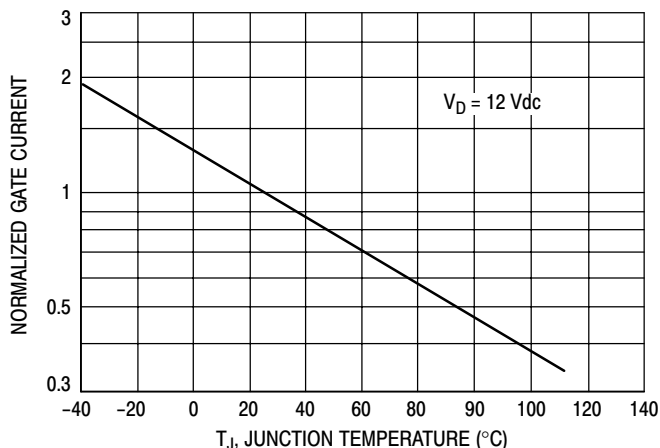

Figure 3. Normalized Gate Current

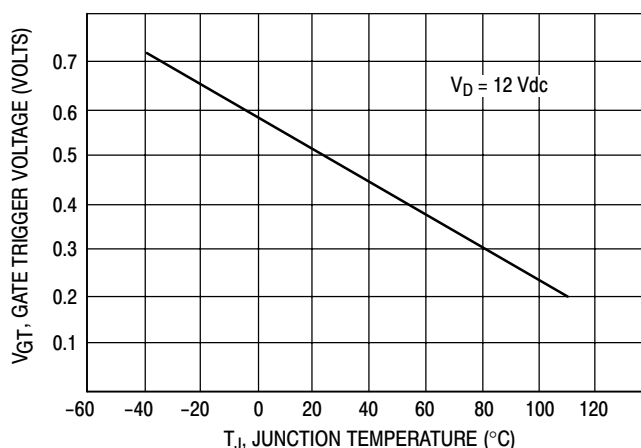
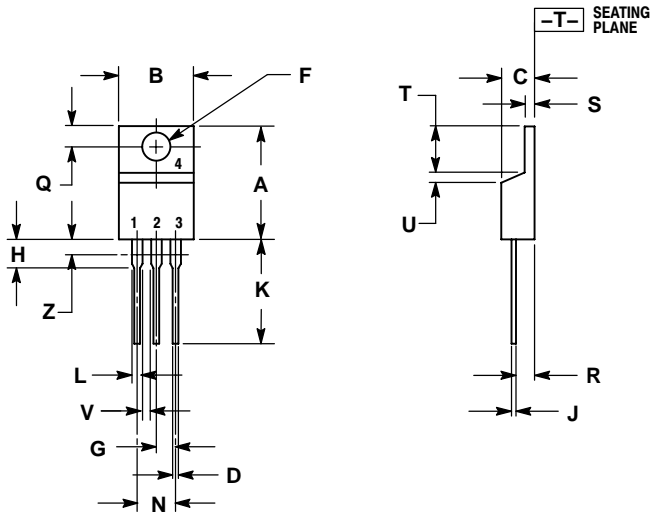

Figure 4. Gate Voltage

# MCR310 Series

## PACKAGE DIMENSIONS

TO-220AB  
CASE 221A-07  
ISSUE AA



NOTES:

1. DIMENSIONING AND TOLERANCING PER ANSI Y14.5M, 1982.
2. CONTROLLING DIMENSION: INCH.
3. DIMENSION Z DEFINES A ZONE WHERE ALL BODY AND LEAD IRREGULARITIES ARE ALLOWED.

DIM	INCHES		MILLIMETERS	
	MIN	MAX	MIN	MAX
A	0.570	0.620	14.48	15.75
B	0.380	0.405	9.66	10.28
C	0.160	0.190	4.07	4.82
D	0.025	0.035	0.64	0.88
F	0.142	0.147	3.61	3.73
G	0.095	0.105	2.42	2.66
H	0.110	0.155	2.80	3.93
J	0.014	0.022	0.36	0.55
K	0.500	0.562	12.70	14.27
L	0.045	0.060	1.15	1.52
N	0.190	0.210	4.83	5.33
Q	0.100	0.120	2.54	3.04
R	0.080	0.110	2.04	2.79
S	0.045	0.055	1.15	1.39
T	0.235	0.255	5.97	6.47
U	0.000	0.050	0.00	1.27
V	0.045	---	1.15	---
Z	---	0.080	---	2.04

STYLE 3:

- PIN 1. CATHODE
- ANODE
- GATE
- ANODE

ON Semiconductor and  are registered trademarks of Semiconductor Components Industries, LLC (SCILLC). SCILLC reserves the right to make changes without further notice to any products herein. SCILLC makes no warranty, representation or guarantee regarding the suitability of its products for any particular purpose, nor does SCILLC assume any liability arising out of the application or use of any product or circuit, and specifically disclaims any and all liability, including without limitation special, consequential or incidental damages. "Typical" parameters which may be provided in SCILLC data sheets and/or specifications can and do vary in different applications and actual performance may vary over time. All operating parameters, including "Typicals" must be validated for each customer application by customer's technical experts. SCILLC does not convey any license under its patent rights nor the rights of others. SCILLC products are not designed, intended, or authorized for use as components in systems intended for surgical implant into the body, or other applications intended to support or sustain life, or for any other application in which the failure of the SCILLC product could create a situation where personal injury or death may occur. Should Buyer purchase or use SCILLC products for any such unintended or unauthorized application, Buyer shall indemnify and hold SCILLC and its officers, employees, subsidiaries, affiliates, and distributors harmless against all claims, costs, damages, and expenses, and reasonable attorney fees arising out of, directly or indirectly, any claim of personal injury or death associated with such unintended or unauthorized use, even if such claim alleges that SCILLC was negligent regarding the design or manufacture of the part. SCILLC is an Equal Opportunity/Affirmative Action Employer. This literature is subject to all applicable copyright laws and is not for resale in any manner.

### PUBLICATION ORDERING INFORMATION

LITERATURE FULFILLMENT:

Literature Distribution Center for ON Semiconductor  
P.O. Box 5163, Denver, Colorado 80217 USA  
Phone: 303-675-2175 or 800-344-3860 Toll Free USA/Canada  
Fax: 303-675-2176 or 800-344-3867 Toll Free USA/Canada  
Email: orderlit@onsemi.com

N. American Technical Support: 800-282-9855 Toll Free  
USA/Canada  
Europe, Middle East and Africa Technical Support:  
Phone: 421 33 790 2910  
Japan Customer Focus Center  
Phone: 81-3-5773-3850

ON Semiconductor Website: [www.onsemi.com](http://www.onsemi.com)

Order Literature: <http://www.onsemi.com/orderlit>

For additional information, please contact your local Sales Representative

# Mouser Electronics

Authorized Distributor

Click to View Pricing, Inventory, Delivery & Lifecycle Information:

[ON Semiconductor:](#)

[MCR310-10G](#)