

NTA4151P, NTE4151P

Small Signal MOSFET

-20 V, -760 mA, Single P-Channel,
Gate Zener, SC-75, SC-89

Features

- Low $R_{DS(on)}$ for Higher Efficiency and Longer Battery Life
- Small Outline Package (1.6 x 1.6 mm)
- SC-75 Standard Gullwing Package
- ESD Protected Gate
- These Devices are Pb-Free, Halogen Free/BFR Free and are RoHS Compliant

Applications

- High Side Load Switch
- DC-DC Conversion
- Small Drive Circuits
- Battery Operated Systems such as Cell Phones, PDAs, Digital Cameras, etc.

MAXIMUM RATINGS ($T_J = 25^\circ\text{C}$ unless otherwise stated)

| Parameter | | Symbol | Value | Units |
|---|------------------------|----------------|------------|------------------|
| Drain-to-Source Voltage | | V_{DSS} | -20 | V |
| Gate-to-Source Voltage | | V_{GS} | ± 6.0 | V |
| Continuous Drain Current (Note 1) | Steady State | I_D | -760 | mA |
| Power Dissipation (Note 1) | Steady State | P_D | 301 | mW |
| SC-75 SC-89 | | | 313 | |
| Pulsed Drain Current | $t_p = 10 \mu\text{s}$ | I_{DM} | ± 1000 | mA |
| Operating Junction and Storage Temperature | | T_J, T_{STG} | -55 to 150 | $^\circ\text{C}$ |
| Continuous Source Current (Body Diode) | | I_S | -250 | mA |
| Lead Temperature for Soldering Purposes (1/8 in from case for 10 s) | | T_L | 260 | $^\circ\text{C}$ |
| Gate-to-Source ESD Rating – (Human Body Model, Method 3015) | | ESD | 1800 | V |

THERMAL RESISTANCE RATINGS

| Junction-to-Ambient – Steady State (Note 1) | $R_{\theta JA}$ | | $^\circ\text{C/W}$ |
|---|-----------------|-----|--------------------|
| SC-75 | | 415 | |
| SC-89 | | 400 | |

Stresses exceeding those listed in the Maximum Ratings table may damage the device. If any of these limits are exceeded, device functionality should not be assumed, damage may occur and reliability may be affected.

1. Surface mounted on FR4 board using 1 in sq pad size (Cu area = 1.127 in sq [1 oz] including traces).



ON Semiconductor®

www.onsemi.com

| $V_{(BR)DSS}$ | $R_{DS(on)}$ TYP | I_D MAX |
|---------------|------------------------|-----------|
| -20 V | 0.26 Ω @ -4.5 V | -760 mA |
| | 0.35 Ω @ -2.5 V | |
| | 0.49 Ω @ -1.8 V | |

P-Channel MOSFET

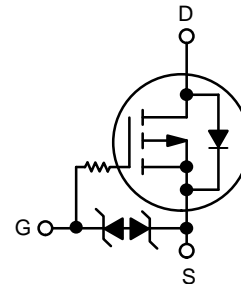

MARKING DIAGRAM & PIN ASSIGNMENT

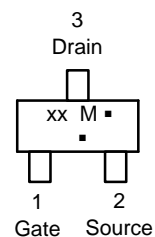
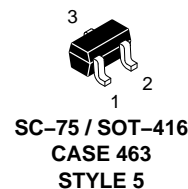

- xx = Device Code
- M = Date Code*
- = Pb-Free Package

(Note: Microdot may be in either location)

*Date Code orientation may vary depending upon manufacturing location.

ORDERING INFORMATION

See detailed ordering and shipping information in the package dimensions section on page 2 of this data sheet.

NTA4151P, NTE4151P

ELECTRICAL CHARACTERISTICS (T_J = 25°C unless otherwise stated)

| Parameter | Symbol | Test Condition | Min | Typ | Max | Unit |
|-----------|--------|----------------|-----|-----|-----|------|
|-----------|--------|----------------|-----|-----|-----|------|

OFF CHARACTERISTICS

| | | | | | | |
|-----------------------------------|----------------------|---|-----|------|------|----|
| Drain-to-Source Breakdown Voltage | V _{(BR)DSS} | V _{GS} = 0 V, I _D = -250 μA | -20 | | | V |
| Zero Gate Voltage Drain Current | I _{DSS} | V _{GS} = 0 V, V _{DS} = -16 V | | -1.0 | -100 | nA |
| Gate-to-Source Leakage Current | I _{GSS} | V _{DS} = 0 V, V _{GS} = ±4.5 V | | ±1.0 | ±10 | μA |

ON CHARACTERISTICS (Note 2)

| | | | | | | |
|-------------------------------|---------------------|--|-------|------|------|---|
| Gate Threshold Voltage | V _{GS(TH)} | V _{DS} = V _{GS} , I _D = -250 μA | -0.45 | | -1.2 | V |
| Drain-to-Source On Resistance | R _{DS(on)} | V _{GS} = -4.5 V, I _D = -350 mA | | 0.26 | 0.36 | Ω |
| | | V _{GS} = -2.5 V, I _D = -300 mA | | 0.35 | 0.45 | |
| | | V _{GS} = -1.8 V, I _D = -150 mA | | 0.49 | 1.0 | |
| Forward Transconductance | g _{FS} | V _{DS} = -10 V, I _D = -250 mA | | 0.4 | | S |

CHARGES AND CAPACITANCES

| | | | | | | |
|------------------------------|---------------------|---|--|-------|--|----|
| Input Capacitance | C _{ISS} | V _{GS} = 0 V, f = 1.0 MHz, V _{DS} = -5.0 V | | 156 | | pF |
| Output Capacitance | C _{OSS} | | | 28 | | |
| Reverse Transfer Capacitance | C _{RSS} | | | 18 | | |
| Total Gate Charge | Q _{G(TOT)} | V _{GS} = -4.5 V, V _{DD} = -10 V, I _D = -0.3 A | | 2.1 | | nC |
| Threshold Gate Charge | Q _{G(TH)} | | | 0.125 | | |
| Gate-to-Source Charge | Q _{GS} | | | 0.325 | | |
| Gate-to-Drain Charge | Q _{GD} | | | 0.5 | | |

SWITCHING CHARACTERISTICS (Note 3)

| | | | | | | |
|---------------------|---------------------|---|--|------|--|----|
| Turn-On Delay Time | t _{d(ON)} | V _{GS} = -4.5 V, V _{DD} = -10 V, I _D = -200 mA, R _G = 10 Ω | | 8.0 | | ns |
| Rise Time | t _r | | | 8.2 | | |
| Turn-Off Delay Time | t _{d(OFF)} | | | 29 | | |
| Fall Time | t _f | | | 20.4 | | |

DRAIN-SOURCE DIODE CHARACTERISTICS

| | | | | | | |
|-----------------------|-----------------|---|--|-------|------|---|
| Forward Diode Voltage | V _{SD} | V _{GS} = 0 V, I _S = -250 mA | | -0.72 | -1.1 | V |
|-----------------------|-----------------|---|--|-------|------|---|

Product parametric performance is indicated in the Electrical Characteristics for the listed test conditions, unless otherwise noted. Product performance may not be indicated by the Electrical Characteristics if operated under different conditions.

2. Pulse Test: pulse width ≤ 300 μs, duty cycle ≤ 2%.

3. Switching characteristics are independent of operating junction temperatures.

ORDERING INFORMATION

| Device | Marking | Package | Shipping† |
|-------------|---------|--------------------|--------------------|
| NTA4151PT1G | TN | SC-75 (Pb-Free) | 3000 / Tape & Reel |
| NTE4151PT1G | TM | SC-89 (Pb-Free) | 3000 / Tape & Reel |

†For information on tape and reel specifications, including part orientation and tape sizes, please refer to our Tape and Reel Packaging Specifications Brochure, BRD8011/D.

NTA4151P, NTE4151P

TYPICAL ELECTRICAL CHARACTERISTICS

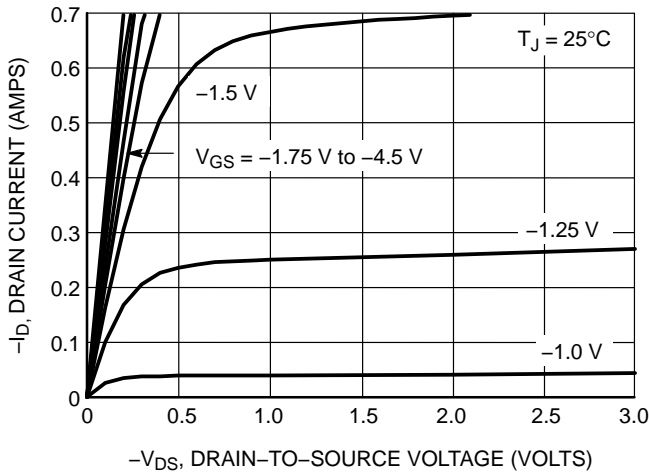

Figure 1. On-Region Characteristics

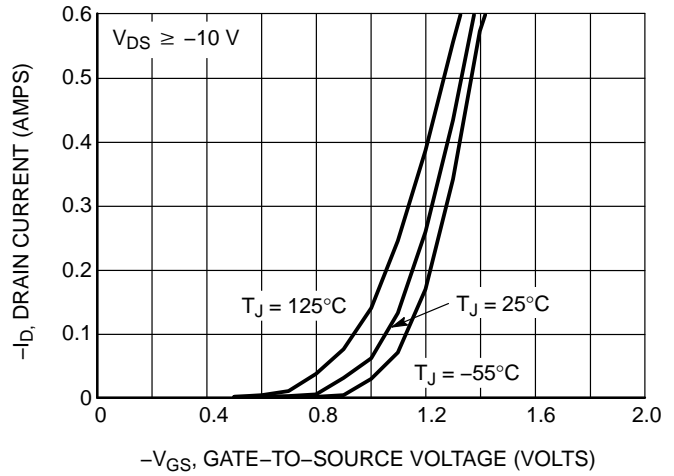

Figure 2. Transfer Characteristics

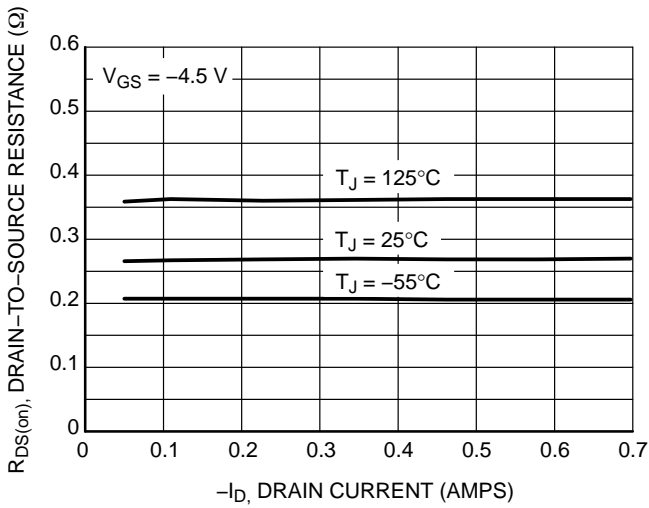

Figure 3. On-Resistance vs. Drain Current and Temperature

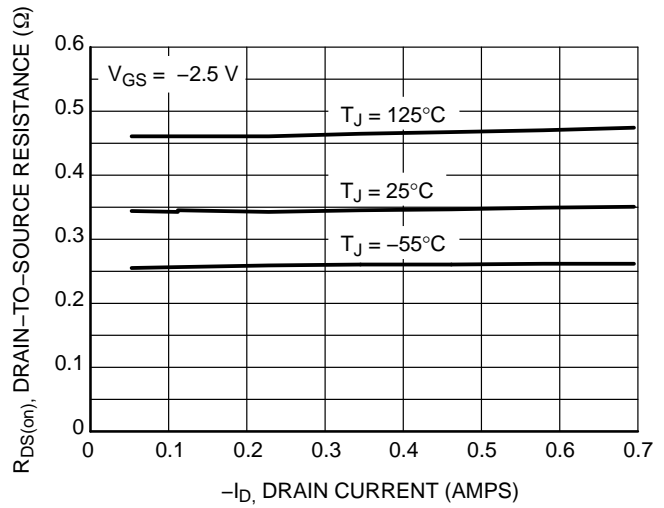

Figure 4. On-Resistance vs. Drain Current and Temperature

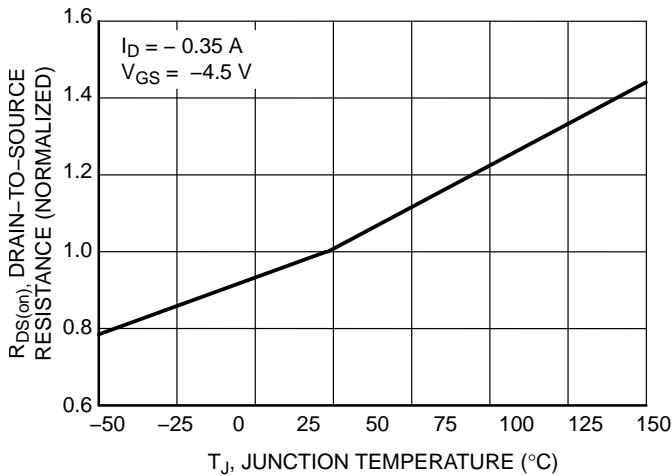

Figure 5. On-Resistance Variation with Temperature

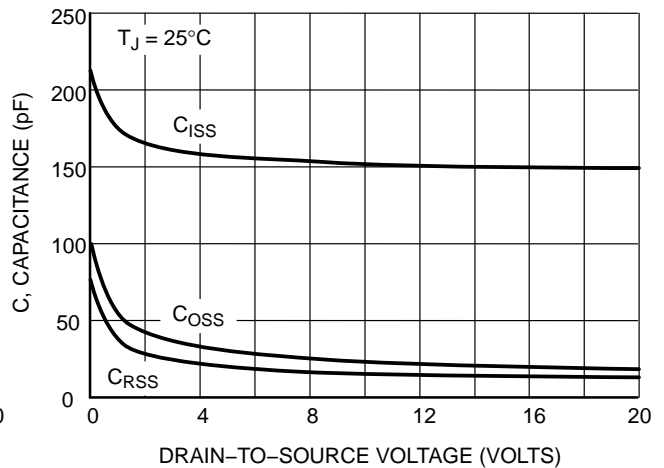

Figure 6. Capacitance Variation

NTA4151P, NTE4151P

TYPICAL ELECTRICAL CHARACTERISTICS

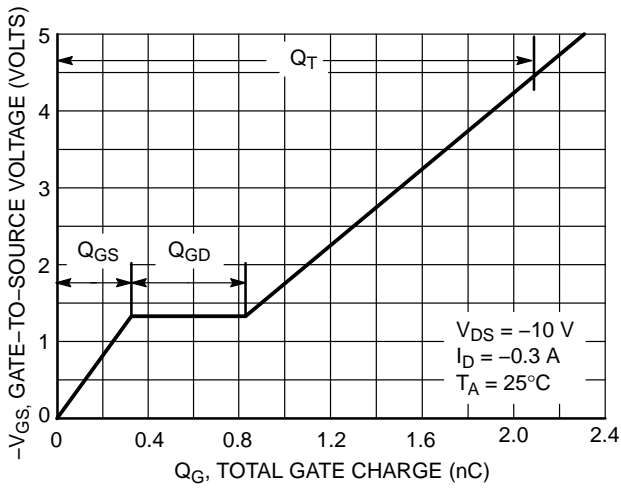

Figure 7. Gate-to-Source Voltage vs. Total Gate Charge

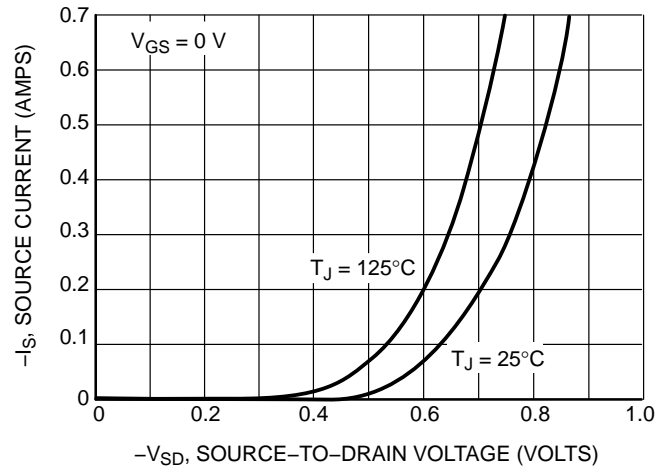

Figure 8. Diode Forward Voltage vs. Current

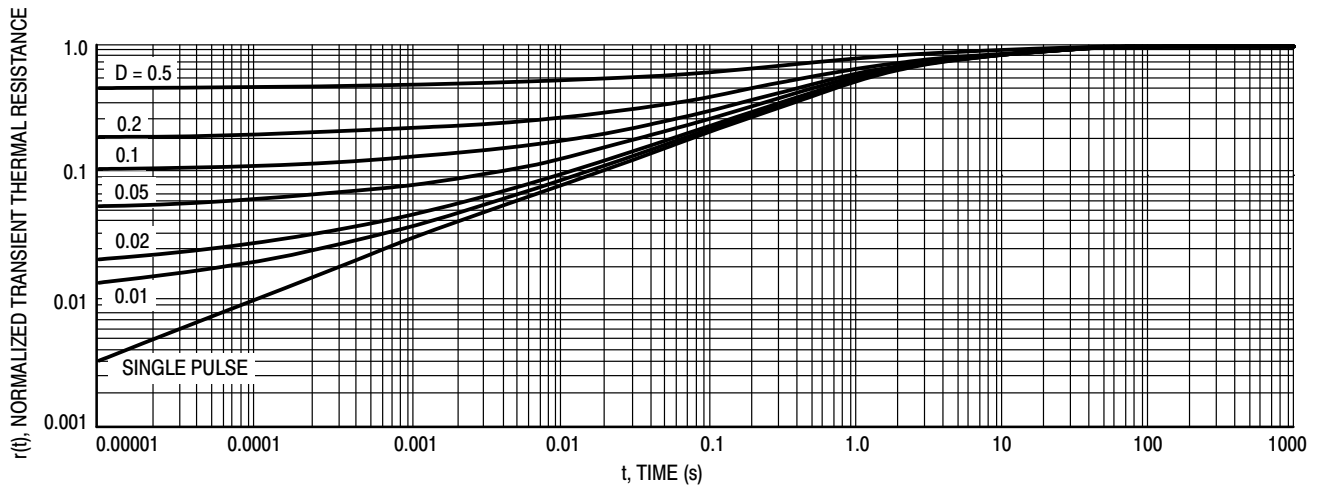
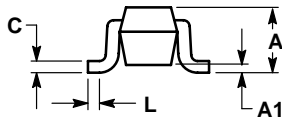
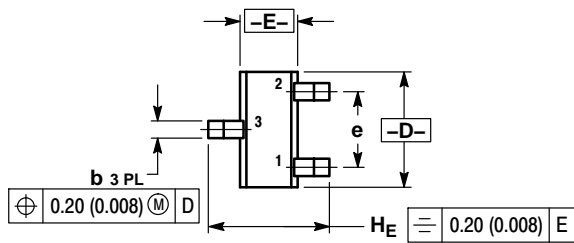

Figure 9. Normalized Thermal Response

NTA4151P, NTE4151P

PACKAGE DIMENSIONS

SC-75/SOT-416
CASE 463
ISSUE F



- NOTES:
1. DIMENSIONING AND TOLERANCING PER ANSI Y14.5M, 1982.
2. CONTROLLING DIMENSION: MILLIMETER.

| DIM | MILLIMETERS | | | INCHES | | |
|----------------|-------------|------|------|----------|-------|-------|
| | MIN | NOM | MAX | MIN | NOM | MAX |
| A | 0.70 | 0.80 | 0.90 | 0.027 | 0.031 | 0.035 |
| A1 | 0.00 | 0.05 | 0.10 | 0.000 | 0.002 | 0.004 |
| b | 0.15 | 0.20 | 0.30 | 0.006 | 0.008 | 0.012 |
| C | 0.10 | 0.15 | 0.25 | 0.004 | 0.006 | 0.010 |
| D | 1.55 | 1.60 | 1.65 | 0.059 | 0.063 | 0.067 |
| E | 0.70 | 0.80 | 0.90 | 0.027 | 0.031 | 0.035 |
| e | 1.00 BSC | | | 0.04 BSC | | |
| L | 0.10 | 0.15 | 0.20 | 0.004 | 0.006 | 0.008 |
| H _E | 1.50 | 1.60 | 1.70 | 0.061 | 0.063 | 0.065 |

- STYLE 5:
PIN 1. GATE
2. SOURCE
3. DRAIN

SOLDERING FOOTPRINT*

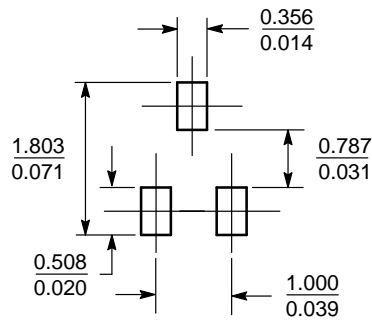

SCALE 10:1 ($\frac{\text{mm}}{\text{inches}}$)

*For additional information on our Pb-Free strategy and soldering details, please download the ON Semiconductor Soldering and Mounting Techniques Reference Manual, SOLDERRM/D.

NTA4151P, NTE4151P

PACKAGE DIMENSIONS

SC-89, 3-LEAD
CASE 463C-03
ISSUE C

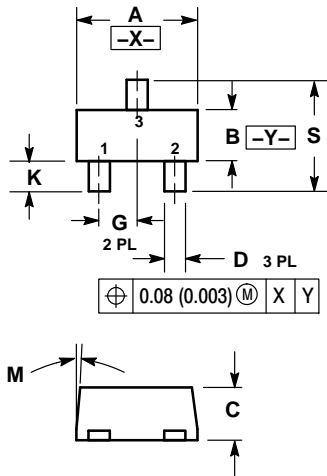

NOTES:

1. DIMENSIONING AND TOLERANCING PER ANSI Y14.5M, 1982.
2. CONTROLLING DIMENSION: MILLIMETERS
3. MAXIMUM LEAD THICKNESS INCLUDES LEAD FINISH THICKNESS. MINIMUM LEAD THICKNESS IS THE MINIMUM THICKNESS OF BASE MATERIAL.
4. 463C-01 OBSOLETE, NEW STANDARD 463C-02.

| DIM | MILLIMETERS | | | INCHES | | |
|-----|-------------|------|------|-----------|-------|-------|
| | MIN | NOM | MAX | MIN | NOM | MAX |
| A | 1.50 | 1.60 | 1.70 | 0.059 | 0.063 | 0.067 |
| B | 0.75 | 0.85 | 0.95 | 0.030 | 0.034 | 0.040 |
| C | 0.60 | 0.70 | 0.80 | 0.024 | 0.028 | 0.031 |
| D | 0.23 | 0.28 | 0.33 | 0.009 | 0.011 | 0.013 |
| G | 0.50 BSC | | | 0.020 BSC | | |
| H | 0.53 REF | | | 0.021 REF | | |
| J | 0.10 | 0.15 | 0.20 | 0.004 | 0.006 | 0.008 |
| K | 0.30 | 0.40 | 0.50 | 0.012 | 0.016 | 0.020 |
| L | 1.10 REF | | | 0.043 REF | | |
| M | --- | --- | 10 | --- | --- | 10 |
| N | --- | --- | 10 | --- | --- | 10 |
| S | 1.50 | 1.60 | 1.70 | 0.059 | 0.063 | 0.067 |

SOLDERING FOOTPRINT*

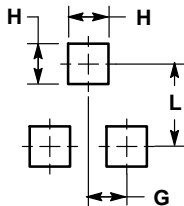

*For additional information on our Pb-Free strategy and soldering details, please download the ON Semiconductor Soldering and Mounting Techniques Reference Manual, SOLDERRM/D.

ON Semiconductor and the  are registered trademarks of Semiconductor Components Industries, LLC (SCILLC) or its subsidiaries in the United States and/or other countries. SCILLC owns the rights to a number of patents, trademarks, copyrights, trade secrets, and other intellectual property. A listing of SCILLC's product/patent coverage may be accessed at www.onsemi.com/site/pdf/Patent-Marketing.pdf. SCILLC reserves the right to make changes without further notice to any products herein. SCILLC makes no warranty, representation or guarantee regarding the suitability of its products for any particular purpose, nor does SCILLC assume any liability arising out of the application or use of any product or circuit, and specifically disclaims any and all liability, including without limitation special, consequential or incidental damages. "Typical" parameters which may be provided in SCILLC data sheets and/or specifications can and do vary in different applications and actual performance may vary over time. All operating parameters, including "Typicals" must be validated for each customer application by customer's technical experts. SCILLC does not convey any license under its patent rights nor the rights of others. SCILLC products are not designed, intended, or authorized for use as components in systems intended for surgical implant into the body, or other applications intended to support or sustain life, or for any other application in which the failure of the SCILLC product could create a situation where personal injury or death may occur. Should Buyer purchase or use SCILLC products for any such unintended or unauthorized application, Buyer shall indemnify and hold SCILLC and its officers, employees, subsidiaries, affiliates, and distributors harmless against all claims, costs, damages, and expenses, and reasonable attorney fees arising out of, directly or indirectly, any claim of personal injury or death associated with such unintended or unauthorized use, even if such claim alleges that SCILLC was negligent regarding the design or manufacture of the part. SCILLC is an Equal Opportunity/Affirmative Action Employer. This literature is subject to all applicable copyright laws and is not for resale in any manner.

PUBLICATION ORDERING INFORMATION

LITERATURE FULFILLMENT:

Literature Distribution Center for ON Semiconductor
P.O. Box 5163, Denver, Colorado 80217 USA
Phone: 303-675-2175 or 800-344-3860 Toll Free USA/Canada
Fax: 303-675-2176 or 800-344-3867 Toll Free USA/Canada
Email: orderlit@onsemi.com

N. American Technical Support: 800-282-9855 Toll Free
USA/Canada
Europe, Middle East and Africa Technical Support:
Phone: 421 33 790 2910
Japan Customer Focus Center
Phone: 81-3-5817-1050

ON Semiconductor Website: www.onsemi.com

Order Literature: <http://www.onsemi.com/orderlit>

For additional information, please contact your local Sales Representative

Mouser Electronics

Authorized Distributor

Click to View Pricing, Inventory, Delivery & Lifecycle Information:

[ON Semiconductor:](#)

[NTA4151PT1H](#)