

# Smart Regulator Series 7 to 26V Input, 1.0A, Fixed Output Voltage 3 terminals DC/DC Regulator



## BP5293-xx Series

### •General Description

The BP5293-xx series is one packaged 3 terminals Buck type DC/DC Converter built-in all parts of DC/DC converter.

High efficiency compared with 3 terminals regulator, and not necessary to heat sink. It's able to rearrange without redesign PCB, because of pin compatible. The built in input/output capacitors and coil is contribute to compact design.

Supplied DC7V~26V output fixed voltage which is 1.8V, 3.3V, 5.0V, 12.0V line up. The output max current is 1A. High efficiency at light load with a SLLM™. It is most suitable for use in the equipment to reduce the standby power is required.

### •Features

- 1ch Buck DC/DC Converter
- SLLM™ control(Simple Light Load Mode)
- Efficiency=70%(@IOUT=2mA)
- Over current protection
- Under voltage lockout protection
- Soft start
- Not need to externals parts
- Small Package

### •Applications

- Consumer applications such as Communication, AV appliances etc.
- Industrial equipment
- Amusement device

etc.

### •Key Specifications

- Input voltage range: 7V to 26 V
- Precision voltage ±2%
- Maximum output current 1A (Max.)
- Operating temperature -25°C to 85°C

### •Appearance



W: 17.0mm x H: 17.8mm x T: 7.2mm (Max.)

### •Line up

Output Voltage Typ. Vo(T)	Product Name
3.3V	BP5293-33
5.0V	BP5293-50
12.0V	BP5293-12

### •Typical Application Circuit

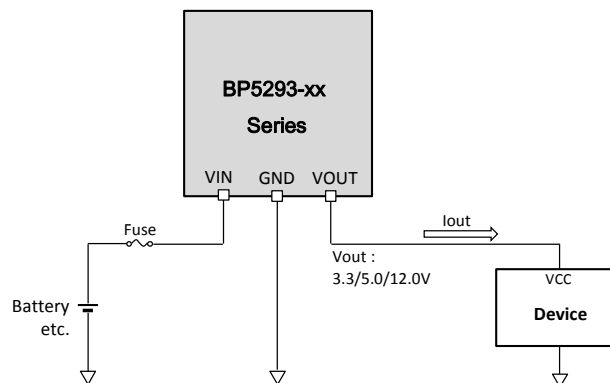

Fig.1 Application circuit

### •Absolute Maximum Ratings (Ta=25°C)

These are the values which must not be exceeded at any time under any application or any test conditions.

Please make design keeping margins accordingly

Parameter	Symbol	Rating	Unit	Conditions
Input Voltage	VinMAX	30	V	VIN terminal
Allowable maximum surface temperature	Tcmax	105	°C	Ambient temperature + The module self-heating $\leq T_{cmax}$
Operating temperature range	Topr	-25 ~ +85	°C	
Storage temperature range	Tstg	-40 ~ +85	°C	
Maximum output current	IoMAX	1000	mA	

### •Recommended Operating Ratings (Ta=-25°C ~ +85°C)

[BP5293-33, BP5293-50]

Parameter	Symbol	Rating			Unit	Conditions
		Min	Typ	Max		
Input Voltage	Vi	7	12	26	V	

[BP5293-12]

Parameter	Symbol	Rating			Unit	Conditions
		Min	Typ	Max		
Input Voltage	Vi	17	20	26	V	

### •Electrical Characteristics

[BP5293-33] (Vi=12V, Io=500mA, Ta = +25°C unless otherwise specified)

Parameter	Symbol	Limits			Unit	Conditions
		Min	Typ	Max		
Output Voltage	Vo(T)	Vo(T) x -3%	Vo(T)	Vo(T) x +3%	V	Io=0mA
Line Regulation	Vln	-	50	100	mV	Vi=7~26V
Load Regulation	Vlo	-	50	200	mV	Io=100~1000mA
Output Ripple voltage	Vp		50	200	mVpp	
Efficiency 1	$\eta_1$	-	70	-	%	Iout=2mA
Efficiency 2	$\eta_2$	86	90	-	%	Iout=1000mA
UVLO Voltage	Vuvlo	6.0	6.4	6.8	V	VIN falling

[BP5293-50] (Vi=12V, Io=500mA, Ta = +25°C unless otherwise specified)

Parameter	Symbol	Limits			Unit	Conditions
		Min	Typ	Max		
Output Voltage	Vo(T)	Vo(T) x -2%	Vo(T)	Vo(T) x +2%	V	Io=0mA
Line Regulation	Vln	-	50	100	mV	Vi=7~26V
Load Regulation	Vlo	-	50	200	mV	Io=100~1000mA
Output Ripple voltage	Vp		50	200	mVpp	
Efficiency 1	$\eta_1$	-	70	-	%	Iout=2mA
Efficiency 2	$\eta_2$	86	90	-	%	Iout=1000mA
UVLO Voltage	Vuvlo	6.0	6.4	6.8	V	VIN falling

[BP5293-12] (  $V_i=20V$ ,  $I_o=500mA$ ,  $T_a = +25^\circ C$  unless otherwise specified)

Parameter	Symbol	Limits			Unit	Conditions
		Min	Typ	Max		
Output Voltage	$V_o(T)$	$V_o(T) \times -3\%$	$V_o(T)$	$V_o(T) \times +3\%$	V	$I_o=0mA$
Line Regulation	$V_{ln}$	-	50	100	mV	$V_i=7\sim 26V$
Load Regulation	$V_{lo}$	-	50	200	mV	$I_o=100\sim 1000mA$
Output Ripple voltage	$V_p$		50	200	mVpp	
Efficiency 1	$\eta_1$	-	70	-	%	$I_{out}=2mA$
Efficiency 2	$\eta_2$	86	90	-	%	$I_{out}=1000mA$
UVLO Voltage	$V_{uvlo}$	6.0	6.4	6.8	V	VIN falling

**Pin Configuration**

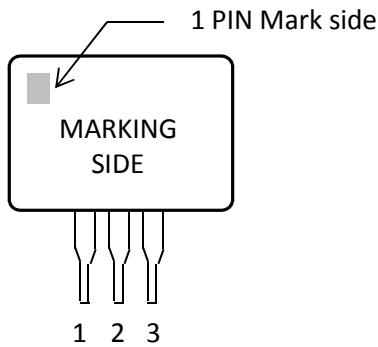

Fig.2 Pin assignment

**•Pin Descriptions**

No	Pin Name	Description	Remarks
1	VIN	Input Power supply terminals	
2	GND	GND	
3	VOU	Output terminals	

●Block Diagram

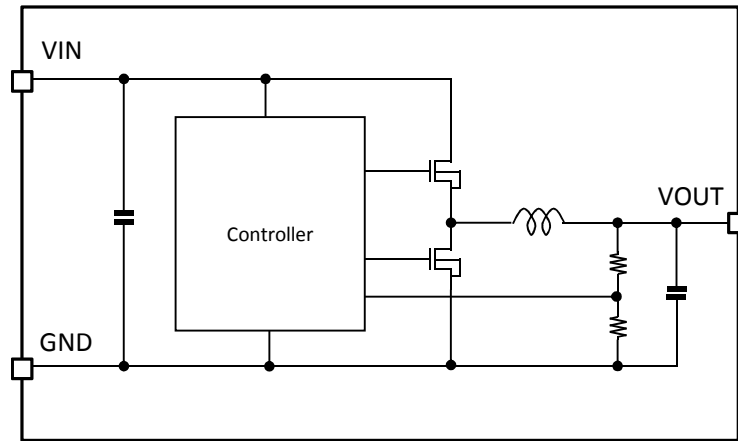

Fig.3 Block diagram

●Description

**1) DC/DC converter function**

BP5293-xx is a synchronous rectifying switching regulator that achieves faster transient response by employing current mode PWM control system. It utilizes switching operation for 570kHz (typ.) in PWM (Pulse Width Modulation) mode for heavier load, while it utilizes SLLM™(Simple Light Load Mode) control for lighter load to improve efficiency. While this mode, the switching function is stopped, it become waveform of output voltage like Fig5-1

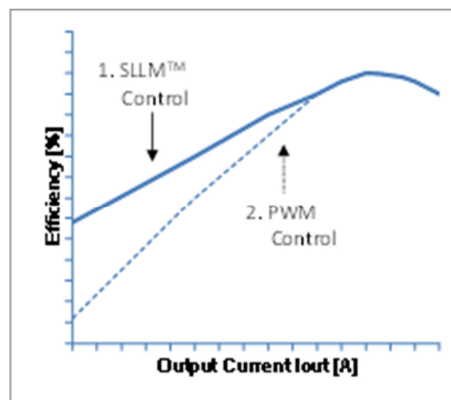

Fig.4 Efficiency (SLLM™ control and PWM control)

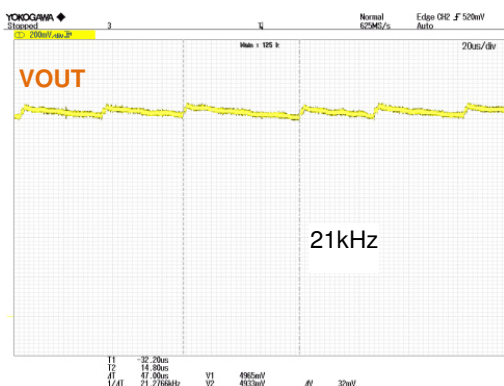

Fig.5-1 Output Waveform (SLLM™ control)  
(Vin=12V, Vout=5.0V, Iout=10mA)

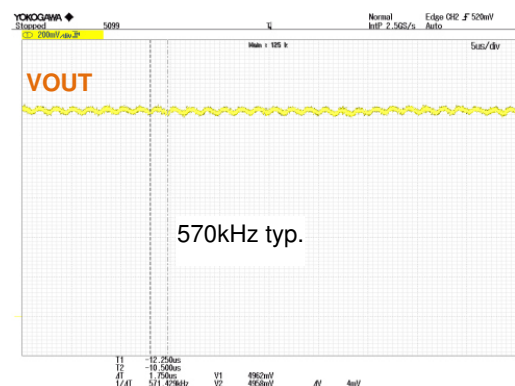

Fig.5-2 SW Waveform(PWM control)  
(Vin=12V, Vout=5.0V, Iout=1000mA)

**2) Protection circuit**

The protective circuits are intended for prevention of damage caused by unexpected accidents. Do not use them for continuous protective operation.

2-1) Short Circuit Protection Function (SCP)

The short circuit protection circuit compares the VOUT terminal voltage with internal standard voltage  $V_{SCP}$ . When the VOUT terminal voltage has fallen below  $V_{SCP}$  and remained there for 0.9 msec (typ.), SCP stops the operation for 14.4 msec (typ.) and subsequently initiates a restart.

Table.1 SCP detection voltage

Product No.	SCP Detection Voltage $V_{SCP}$
BP5293-33	2.3V typ.
BP5293-50	3.5V typ.
BP5293-12	8.5V typ.

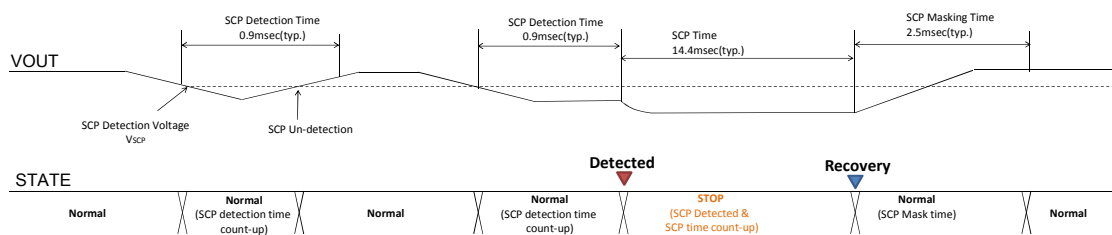

Fig.6 SCP Timing Chart

In the case of using big capacitor (330 $\mu$ F typ. Over), The VOUT rising is slow, the short protection function is maybe available, then take care of output normally.

2-2) Under Voltage Lockout Protection (UVLO)

The under voltage lockout protection circuit monitors the VIN terminal voltage. The operation enters standby when the VIN terminal voltage is 6.4V(typ.) or lower. The operation starts when the VIN terminal voltage is 6.6V(typ.) or higher.

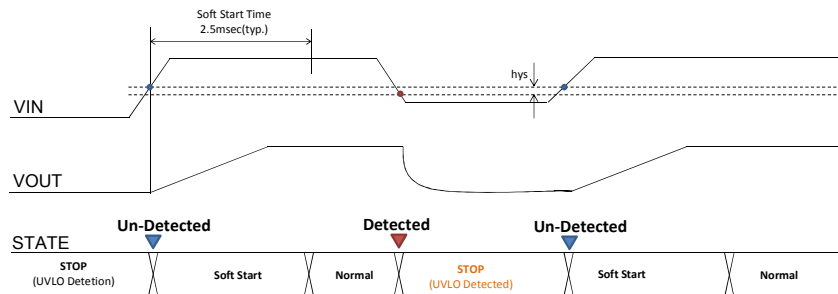

Fig.7 UVLO Timing Chart

2-3) Over Current Protection Function (OCP)

The over current protection function is monitoring every switching terms of input current, protect by dropping output voltage when over current detection.

2-4) Over Voltage Protection Function (OVP)

The over voltage protection function (OVP) compares VOUT terminal voltage with internal standard voltage  $V_{OVP}$  and when VOUT terminal voltage exceeds  $V_{OVP}$  it turns off output. After output voltage drop it returns with hysteresis.

Table.2 OVP detection voltage

Product No.	OVP Detection Voltage $V_{OVP}$
BP5293-33	4.3V typ.
BP5293-50	6.5V typ.
BP5293-12	15.9V typ.

•Typical Performance Curve (Reference data)

• BP5293-33

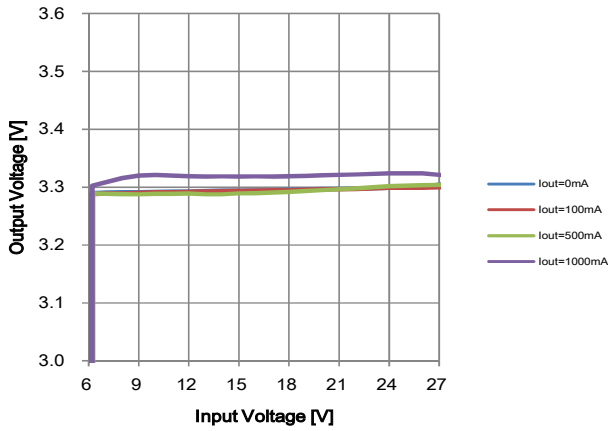

Fig.8-1 LINE Regulation (Vout : BP5293-33)

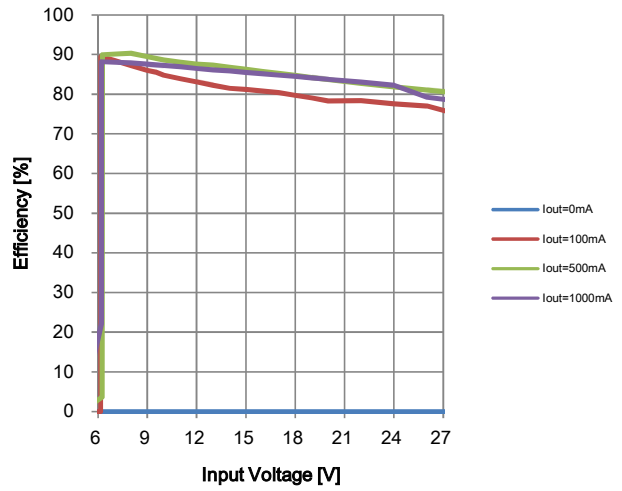

Fig.8-2 LINE Regulation (Efficiency : BP5293-33)

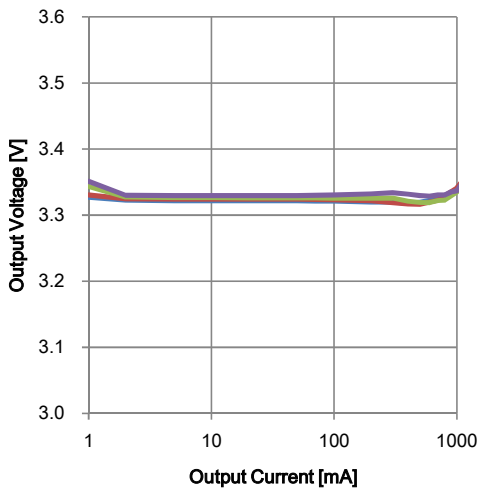

Fig.9-1 LINE Regulation (Vout : BP5293-33)

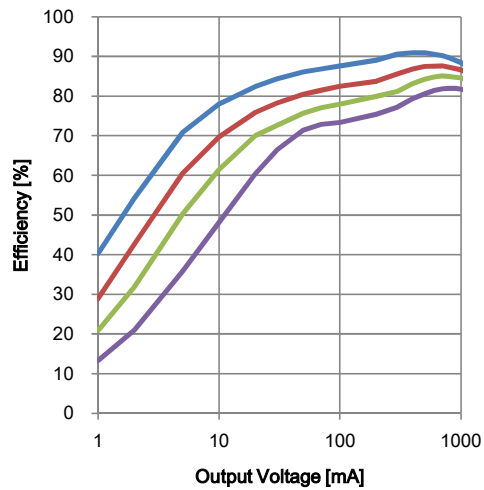

Fig.9-2 LINE Regulation (Efficiency : BP5293-33)

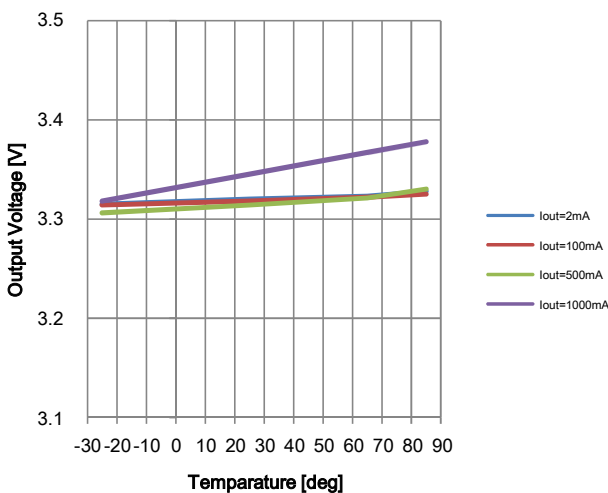

Fig.10-1 Temperature Characteristics (Vout: BP5293-33)

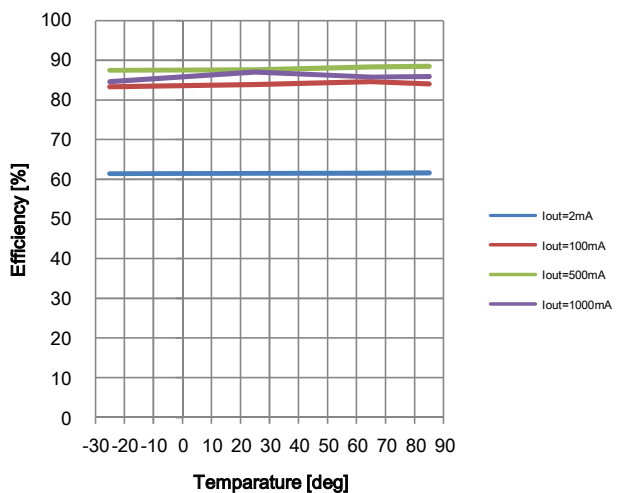

Fig.10-2 Temperature Characteristics (Vout:BP5293-33)

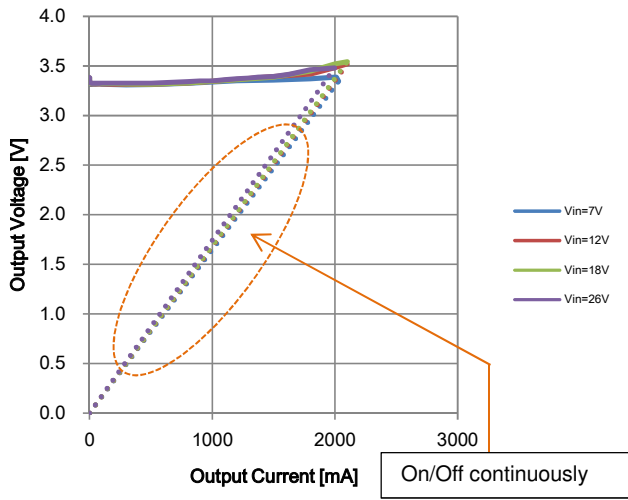

Fig.11 Over Current Limit (Vout : BP5293-33)

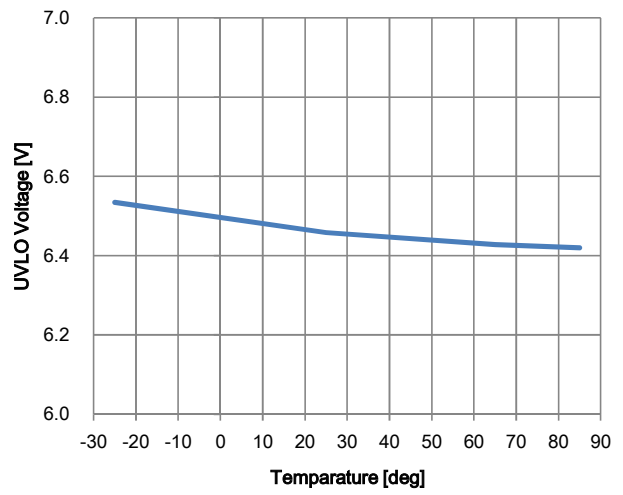

Fig.12 UVLO Voltage (Efficiency : BP5293-33)

• BP5293-50

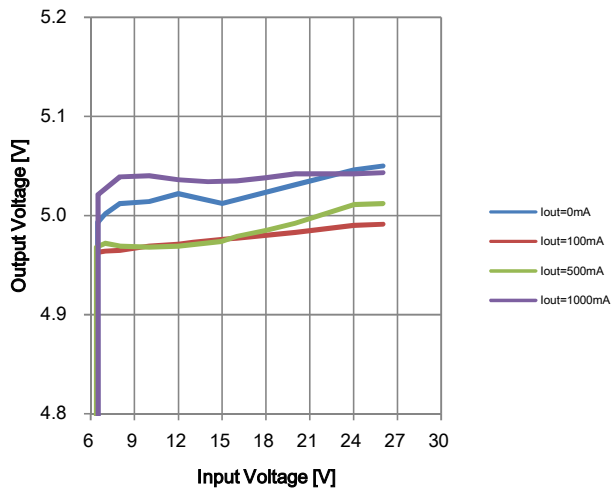

Fig.13-1 LINE Regulation (Vout : BP5293-50)

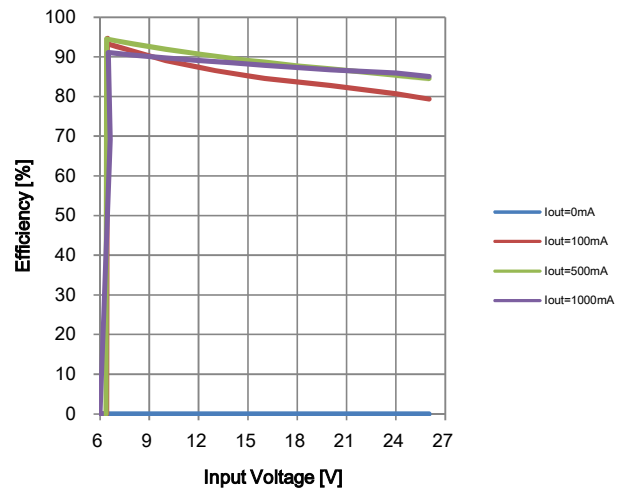

Fig.13-2 LINE Regulation (Efficiency : BP5293-50)

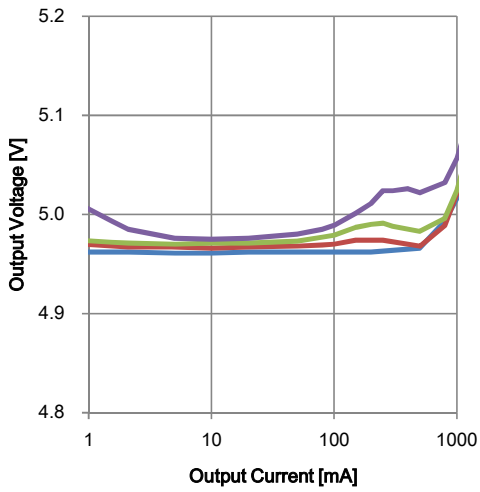

Fig.14-1 LINE Regulation (Vout : BP5293-50)

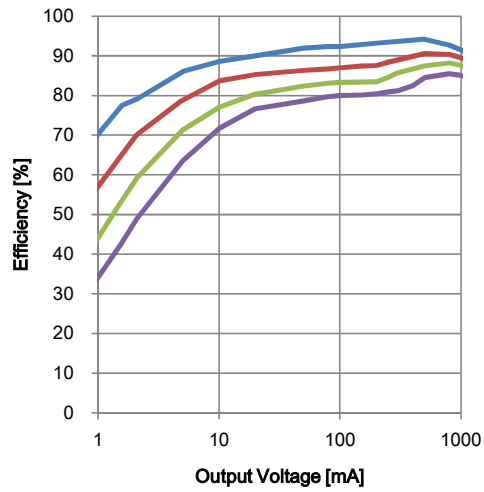

Fig.14-2 LINE Regulation (Efficiency : BP5293-50)

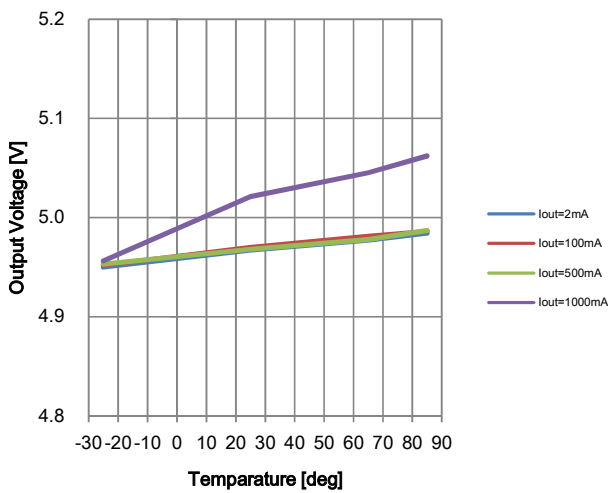

Fig.15-1 Temperature Characteristics (Vout: BP5293-50)

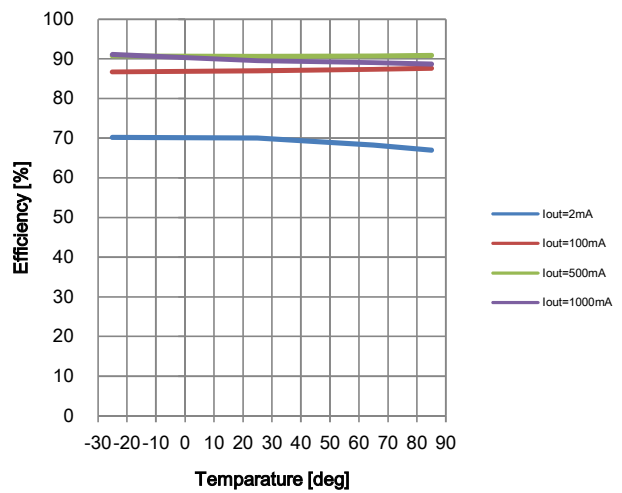

Fig.15-2 Temperature Characteristics (Vout:BP5293-50)



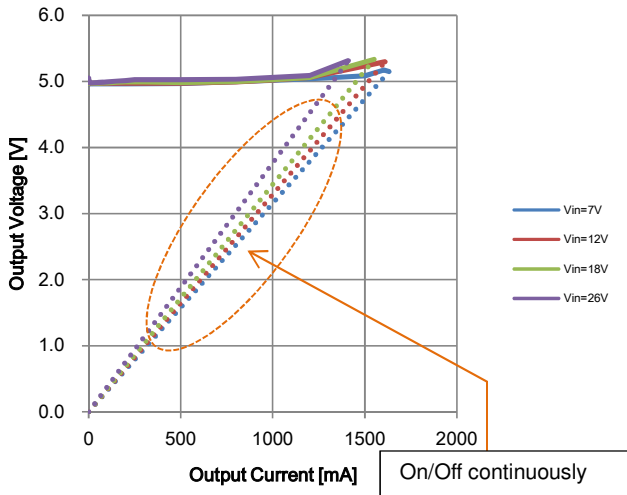

Fig.16 Over Current Limit (Vout : BP5293-50)

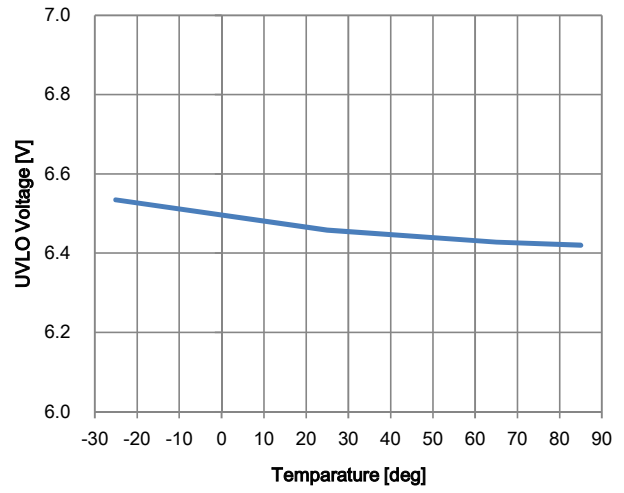

Fig.17 UVLO Voltage (Efficiency : BP5293-50)

• BP5293-12

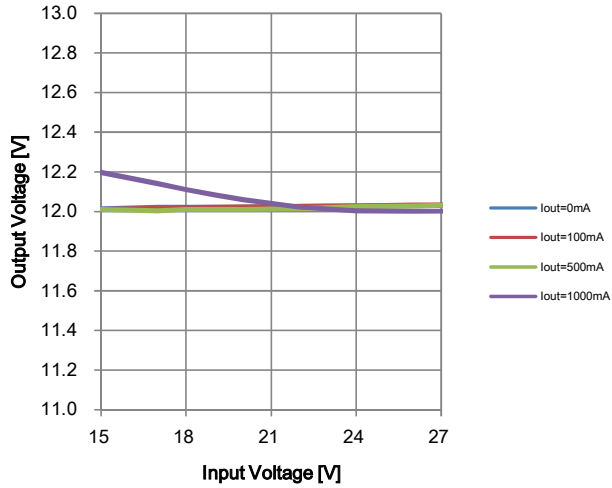

Fig.18-1 LINE Regulation (Vout : BP5293-12)

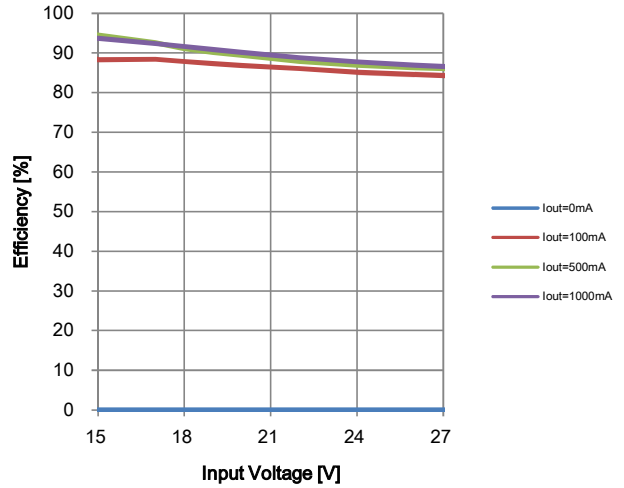

Fig.18-2 LINE Regulation (Efficiency : BP5293-12)

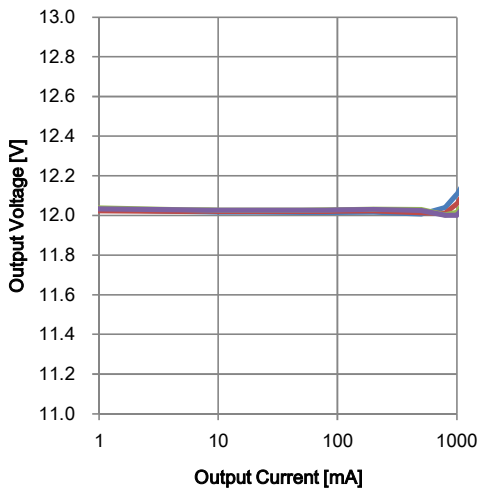

Fig.19-1 LINE Regulation (Vout : BP5293-12)

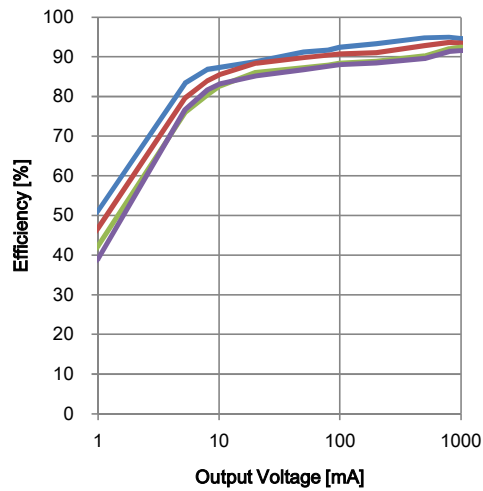

Fig.19-2 LINE Regulation (Efficiency : BP5293-12)

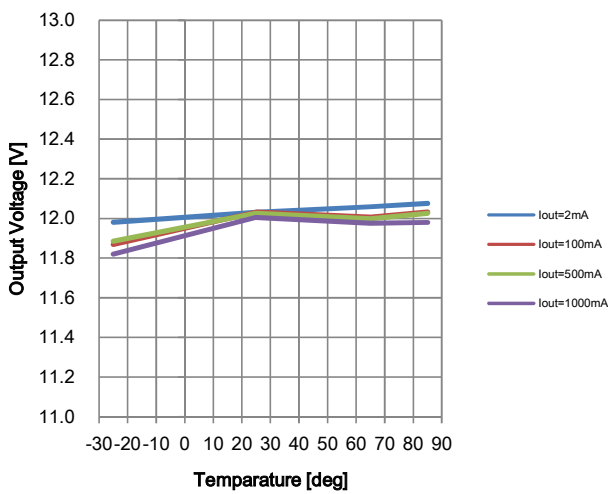

Fig.20-1 Temperature Characteristics (Vout: BP5293-12)

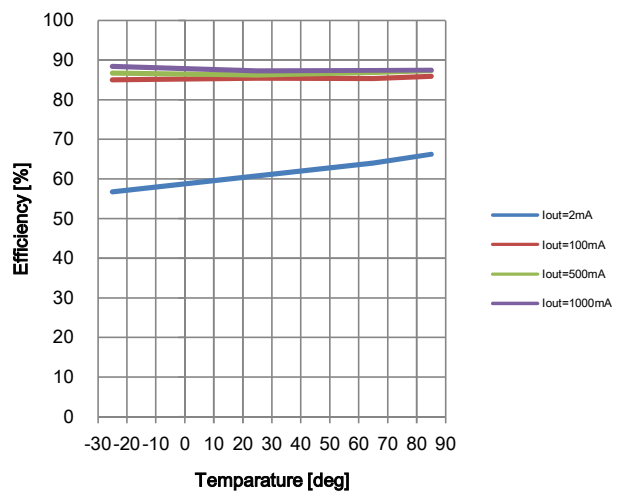

Fig.20-2 Temperature Characteristics (Vout:BP5293-12)

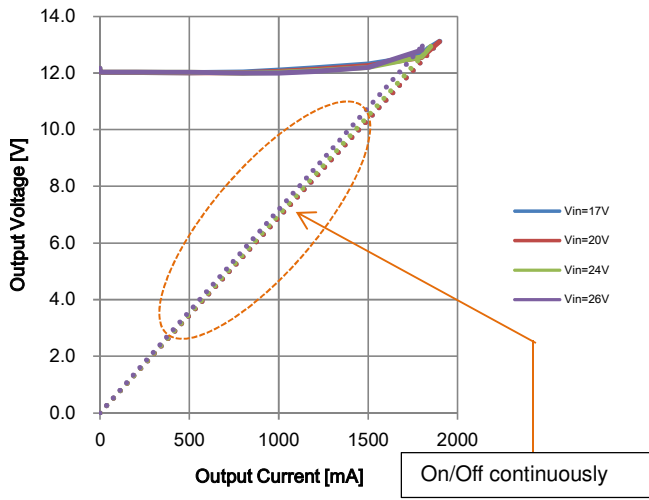

Fig.21 Over Current Limit (Vout : BP5293-12)

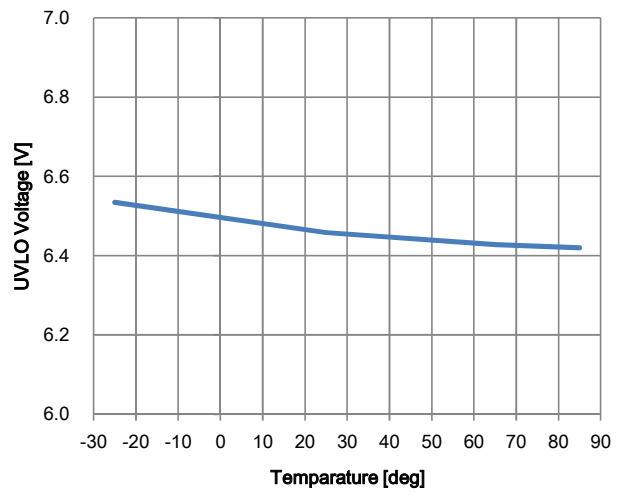

Fig.22 UVLO Voltage (Efficiency : BP5293-12)

● Power Dissipation

The maximum current must be delating for the ambient temperature.

Please make design keeping the below condition

- 1. The ambient temperature of the module keeps the operating condition range(Topr)
- 2. The power loss has enough margins within the power dissipation curve
- 3. The surface temperature is higher than 105°C(Tcmax)

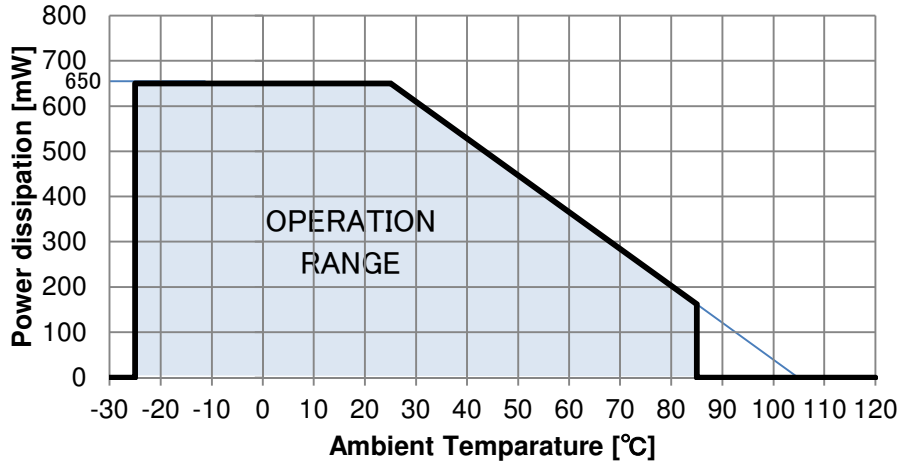

Fig.23 Power dissipation

The surface temperature indicated below line keeps below for allowable maximum surface temperature. If the module condition which its surface temperature is higher than 105°C, the reliability of the module may be compromised.

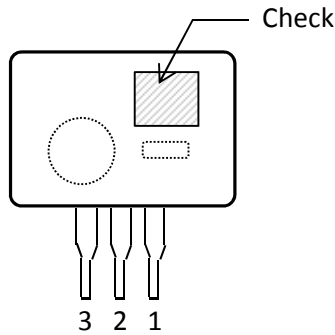

Fig.24 Part of the max heating

● Derating curve

If these power loss condition is satisfied, the derating curve is below graph. The maximum output current is 100mA. Don't use over this.

• BP5293-33

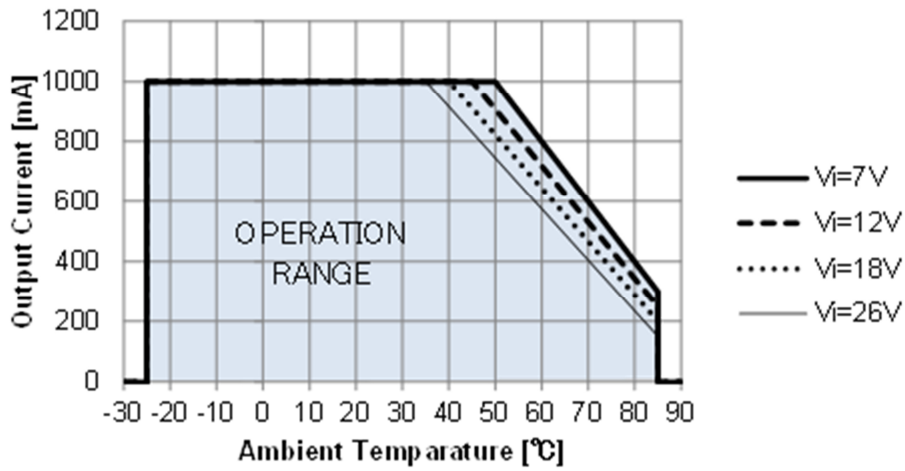

Fig.25 Derating curve(BP5293-33)

• BP5293-50

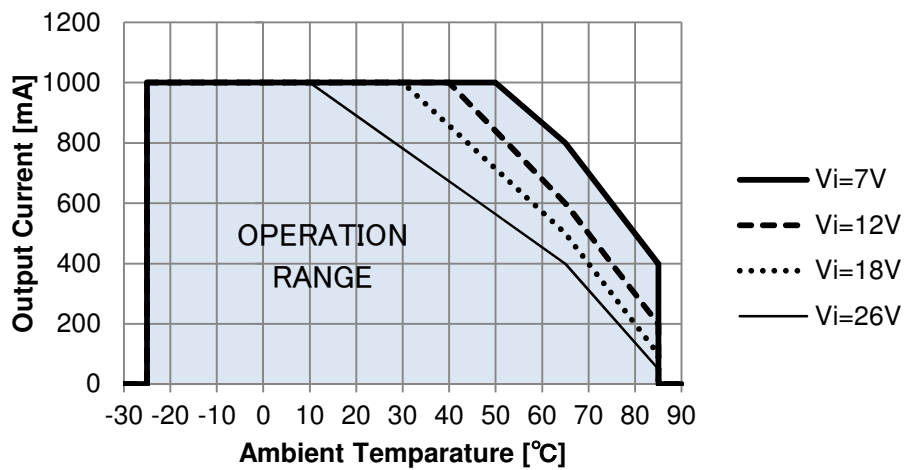

Fig.26 Derating curve(BP5293-50)

• BP5293-12

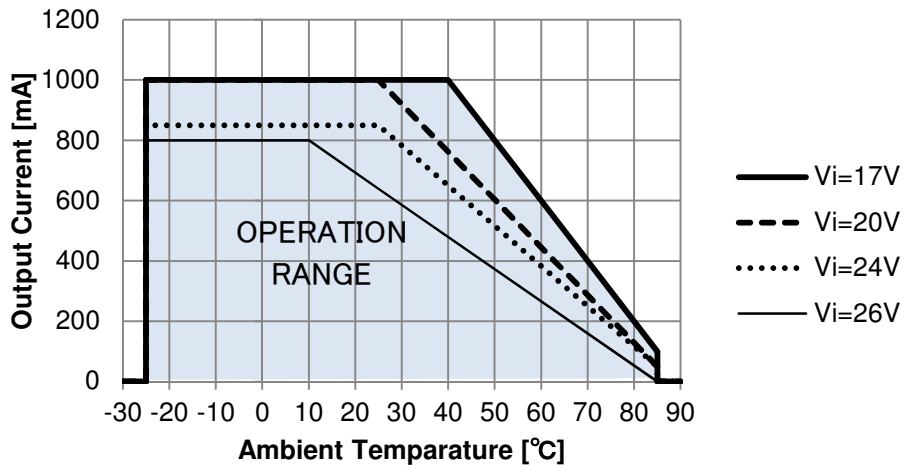

Fig.27 Derating curve (BP5293-12)

If the output current is duty;50%, the derating curve is below graph. The maximum output current is 100mA. Don't use over this.

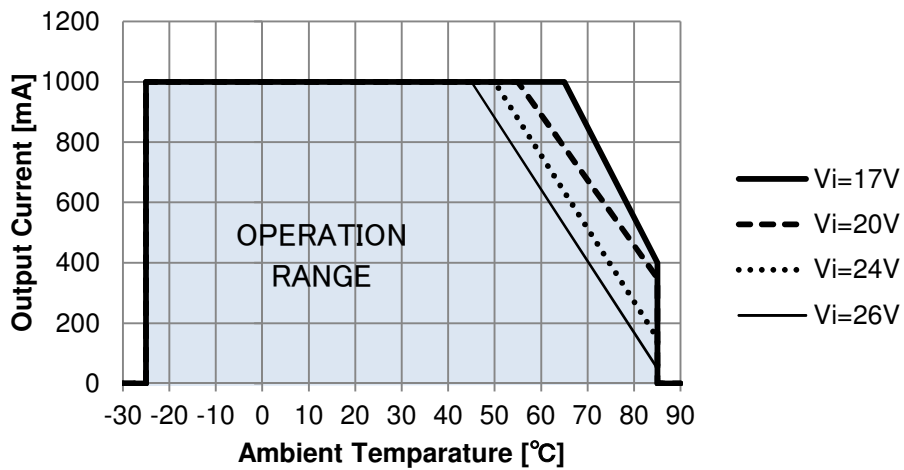

Fig.27-2 Derating curve Duty:50% (BP5293-12)

•Application parts

Recommend adding input or output capacitor as necessary between Input (VIN-GND) and Output (VOUT-GND), though built in capacitor.

1.) Input capacitor

In below the case, add input capacitor (Cin)

- Un-stable because of high ripple input voltage
- Un-stable output because of input voltage dropped when suddenly load changing

2.) Output capacitor

In below the case, add output capacitor (Cout) (Capacitor 10uF~330uF, ESR T.B.D)

- High ripple voltage
- large changing output voltage, when suddenly load changing
- Un-stable output voltage unusually

In the case of using big capacitor (330uF typ Over), The VOUT rising is slow, the short protection function is maybe available, then take care of output normally.

3.) Fuse

Please design safely with fail-safe design not to occur danger or damage, if module is broken by any chance. Connect the "Fuse" adapted specification of input current for protecting continuous over current.

If VIN-GND is shorted accidentally, VOUT terminal may be supplied over voltage. If it's supplied over voltage over 26V, VOUT terminal is broken, and if 3A over current continuously, the module is heat, then smoke or ignition. Please connect the "Fuse" 3A below.

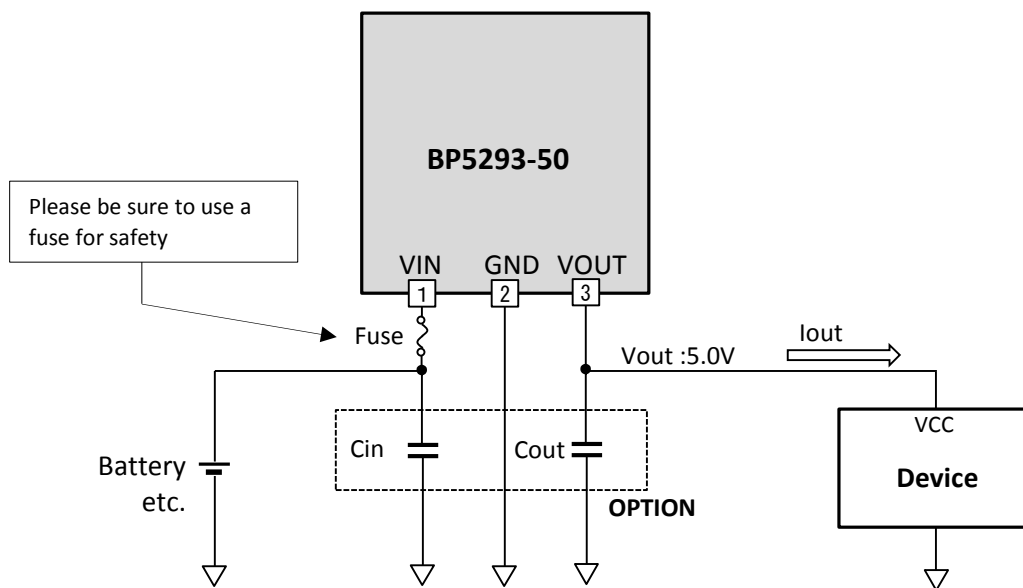

Fig.28 Recommended circuit

•Dimensions

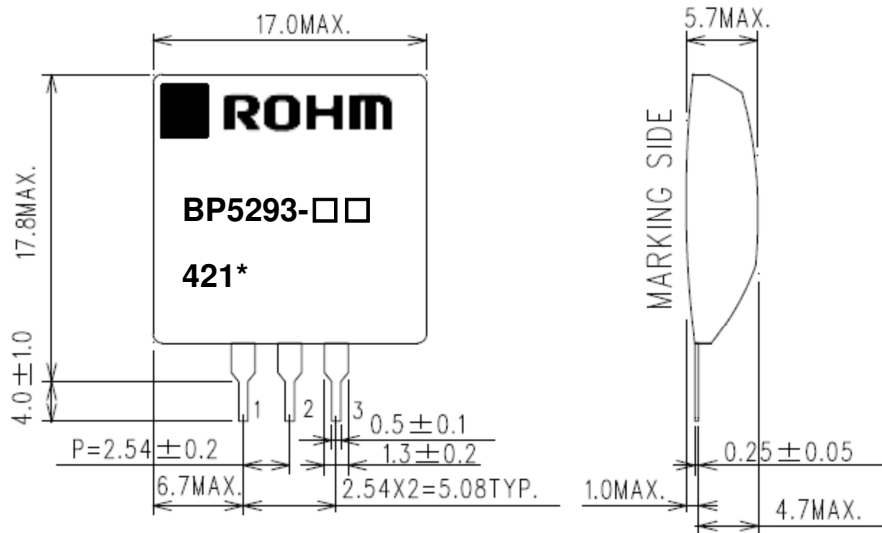

Fig.29 Dimensions (UNIT:mm)

- The external inspection standard is assumed to be a ROHM standard.
- Burr is not covered in above dimension value or tolerance.
- The dimension value without tolerance is a design value.

Marking

■	Pin No.1 Mark
ROHM	Trade Mark
BP5293-□□	Type name
421*	Production Lot Number
	<u>21</u> th week of 201 <u>4</u>
	S:ROHM DALIAN

•Structure

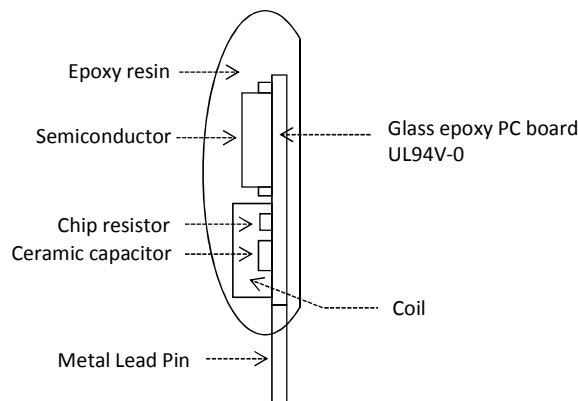

Fig.23 Structure

- Soldering condition
 

Flow soldering	260°C	within 10sec
Manual soldering	380°C	within 3sec
- Recommended land dimensions
 

Hole diameter	1.2mm
Land diameter	2.2mm (Please do cutting land when the interval of the pin is necessary)



●Packing Specification

48 pieces of modules might be packaged in the packaging tray, and it might be piled up 5steps, and with an empty pack on the top, in principle.  
The number of piling might change according to the quantity of delivery without previous notice.  
It is necessary to mount by hand.

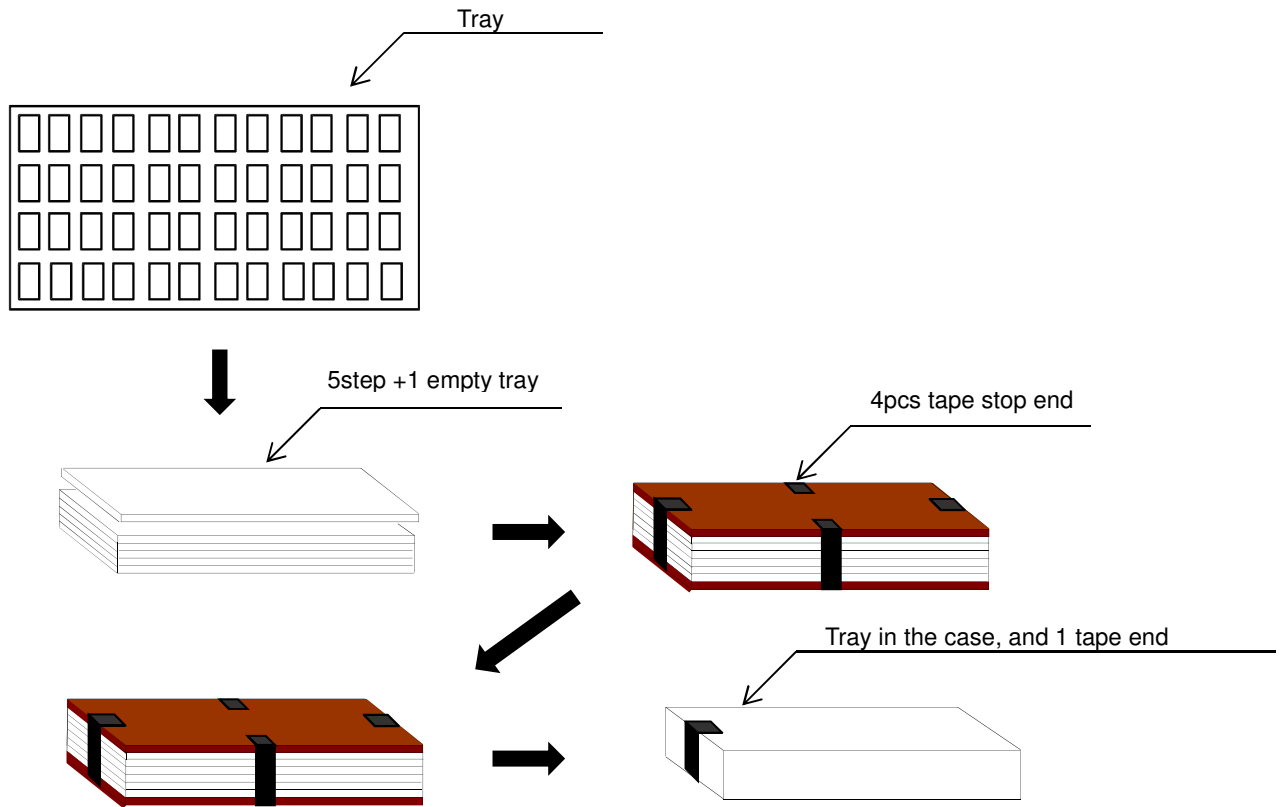

Fig.31 Method of Packing

●Manufacturing Factory

ROHM ELECTRONICS DALIAN CO.,LTD. (CHINA)

**•Caution on use**

1. Although the power supply is paid much attention for quality control, it might be deteriorated or destructed in case it is used beyond the absolute maximum rated value of applied voltage and the operating temperature range. When designing, it should be used in a guarantee range in any case. It might get damaged if used beyond the absolute maximum value of applied voltage and the operating temperature range. In case of damage, the applied mode such as short mode and open mode cannot be specified, therefore please take physical safety measures including the fuse when the special mode which exceeds the absolute maximum rated value is assumed.
2. The GND terminal should be set at the minimum electric potential in any operating conditions.
3. Please design the heat with enough allowance considering derating in the actual use state.
4. The power supply may be damaged because of the excessive stress on the substrate When the lead pin is bent. Please use the lead pin without bending it.
5. At the time of starting the power supply, please set the output light loaded. The power supply line noise and the voltage drop occurred by the motion electric current should be within the hysteresis width of UVLO. When noises more than hysteresis width are input, I may cause malfunction.
6. The power supply is not designed for vehicle installation, military use and equipment affect human life, please do not use it for these purposes. In case used for the said purposes, we do not take any responsibility for the matters not meeting the requirements.
7. The operating temperature range guarantees the function of the power supply, and is not to guarantee the life of it in the range. Since the life of the power supply is subject to derating in accordance with the usage environment such as applied voltage, ambient temperature, and the humidity, please perform the equipment design considering derating.

**•Notice**

This document may not be reprinted or reproduced, in whole or in part, without prior written consent of ROHM.  
This document is reference document. Please check the formal specification by requesting other document.

## Notes

- 1) The information contained herein is subject to change without notice.
- 2) Before you use our Products, please contact our sales representative and verify the latest specifications :
- 3) Although ROHM is continuously working to improve product reliability and quality, semiconductors can break down and malfunction due to various factors.  
Therefore, in order to prevent personal injury or fire arising from failure, please take safety measures such as complying with the derating characteristics, implementing redundant and fire prevention designs, and utilizing backups and fail-safe procedures. ROHM shall have no responsibility for any damages arising out of the use of our Products beyond the rating specified by ROHM.
- 4) Examples of application circuits, circuit constants and any other information contained herein are provided only to illustrate the standard usage and operations of the Products. The peripheral conditions must be taken into account when designing circuits for mass production.
- 5) The technical information specified herein is intended only to show the typical functions of and examples of application circuits for the Products. ROHM does not grant you, explicitly or implicitly, any license to use or exercise intellectual property or other rights held by ROHM or any other parties. ROHM shall have no responsibility whatsoever for any dispute arising out of the use of such technical information.
- 6) The Products are intended for use in general electronic equipment (i.e. AV/OA devices, communication, consumer systems, gaming/entertainment sets) as well as the applications indicated in this document.
- 7) The Products specified in this document are not designed to be radiation tolerant.
- 8) For use of our Products in applications requiring a high degree of reliability (as exemplified below), please contact and consult with a ROHM representative : transportation equipment (i.e. cars, ships, trains), primary communication equipment, traffic lights, fire/crime prevention, safety equipment, medical systems, servers, solar cells, and power transmission systems.
- 9) Do not use our Products in applications requiring extremely high reliability, such as aerospace equipment, nuclear power control systems, and submarine repeaters.
- 10) ROHM shall have no responsibility for any damages or injury arising from non-compliance with the recommended usage conditions and specifications contained herein.
- 11) ROHM has used reasonable care to ensure the accuracy of the information contained in this document. However, ROHM does not warrant that such information is error-free, and ROHM shall have no responsibility for any damages arising from any inaccuracy or misprint of such information.
- 12) Please use the Products in accordance with any applicable environmental laws and regulations, such as the RoHS Directive. For more details, including RoHS compatibility, please contact a ROHM sales office. ROHM shall have no responsibility for any damages or losses resulting from non-compliance with any applicable laws or regulations.
- 13) When providing our Products and technologies contained in this document to other countries, you must abide by the procedures and provisions stipulated in all applicable export laws and regulations, including without limitation the US Export Administration Regulations and the Foreign Exchange and Foreign Trade Act.
- 14) This document, in part or in whole, may not be reprinted or reproduced without prior consent of ROHM.



Thank you for your accessing to ROHM product informations.  
More detail product informations and catalogs are available, please contact us.

## ROHM Customer Support System

<http://www.rohm.com/contact/>

# Mouser Electronics

Authorized Distributor

Click to View Pricing, Inventory, Delivery & Lifecycle Information:

[ROHM Semiconductor:](#)

[BP5293-12](#) [BP5293-33](#) [BP5293-50](#)