

● Structure

Silicon N-channel MOSFET

● Features

- 1) Low On-resistance.
- 2) Space saving, small surface mount package (TSMT6).
- 3) 1.5V drive

● Applications

Switching

● Packaging specifications

Type	Package	Taping
	Code	TR
	Basic ordering unit (pieces)	3000
	Marking	FD

● Dimensions

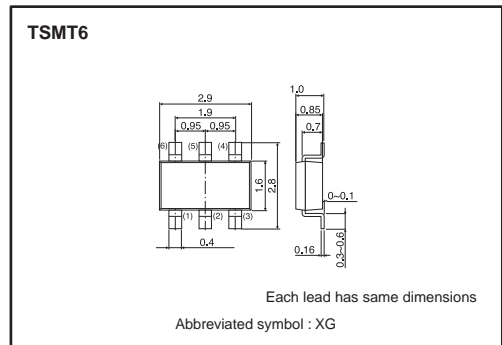

● Inner circuit

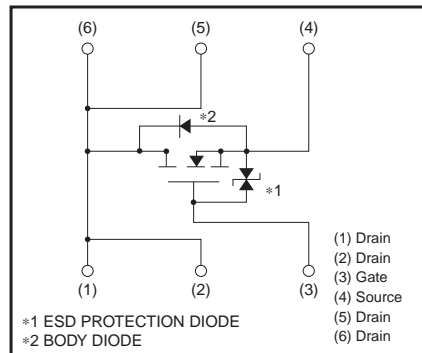

● Absolute maximum ratings (Ta=25°C)

Parameter		Symbol	Limits	Unit
Drain-source voltage		V_{DSS}	20	V
Gate-source voltage		V_{GSS}	± 10	V
Drain current	Continuous	I_D	± 5.0	A
	Pulsed	I_{DP} *1	± 10	A
Source current (Body diode)	Continuous	I_S	1.0	A
	Pulsed	I_{SP} *1	10	A
Total power dissipation		P_D *2	1.25	W
Channel temperature		T_{ch}	150	°C
Range of storage temperature		T_{stg}	-55 to +150	°C

*1 $P_w \leq 10\mu s$, Duty cycle $\leq 1\%$

*2 Mounted on a ceramic board

● Thermal resistance

Parameter	Symbol	Limits	Unit
Channel to ambient	$R_{th(ch-a)}$ *	100	°C/W

* Mounted on a ceramic board

● Electrical characteristics (Ta=25°C)

Parameter	Symbol	Min.	Typ.	Max.	Unit	Conditions
Gate-source leakage	I _{GSS}	–	–	±10	μA	V _{GS} =±10V, V _{DS} =0V
Drain-source breakdown voltage	V _{(BR) DSS}	20	–	–	V	I _D = 1mA, V _{GS} =0V
Zero gate voltage drain current	I _{DSS}	–	–	1	μA	V _{DS} = 20V, V _{GS} =0V
Gate threshold voltage	V _{GS (th)}	0.3	–	1.0	V	V _{DS} = 10V, I _D = 1mA
Static drain-source on-state resistance	R _{DS (on)} *	–	22	30	mΩ	I _D = 5.0A, V _{GS} = 4.5V
		–	27	38	mΩ	I _D = 5.0A, V _{GS} = 2.5V
		–	32	45	mΩ	I _D = 2.5A, V _{GS} = 1.8V
		–	40	80	mΩ	I _D = 1.0A, V _{GS} = 1.5V
Forward transfer admittance	Y _{fs} *	6.5	–	–	S	V _{DS} = 10V, I _D = 5.0A
Input capacitance	C _{iss}	–	900	–	pF	V _{DS} = 10V
Output capacitance	C _{oss}	–	190	–	pF	V _{GS} =0V
Reverse transfer capacitance	C _{rss}	–	120	–	pF	f=1MHz
Turn-on delay time	t _{d (on)} *	–	15	–	ns	V _{DD} ≐ 10V
Rise time	t _r *	–	25	–	ns	I _D = 2.5A V _{GS} = 4.5V
Turn-off delay time	t _{d (off)} *	–	70	–	ns	R _L ≐ 4Ω
Fall time	t _f *	–	100	–	ns	R _G =10Ω
Total gate charge	Q _g *	–	12	–	nC	V _{DD} ≐ 10V, I _D = 5.0A
Gate-source charge	Q _{gs} *	–	2.5	–	nC	V _{GS} = 4.5V
Gate-drain charge	Q _{gd} *	–	1.7	–	nC	R _L ≐ 2Ω, R _G =10Ω

*Pulsed

● Body diode characteristics (Source-drain) (Ta=25°C)

Parameter	Symbol	Min.	Typ.	Max.	Unit	Conditions
Forward voltage	V _{SD} *	–	–	1.2	V	I _S = 1.0A, V _{GS} =0V

*Pulsed

● Electrical characteristics curves

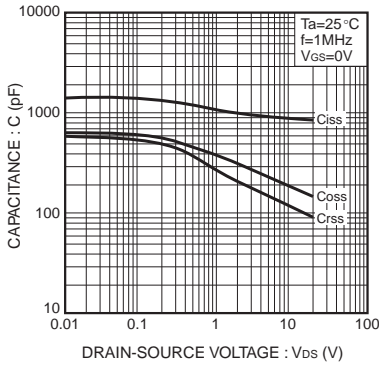

Fig.1 Typical Capacitance vs. Drain-Source Voltage

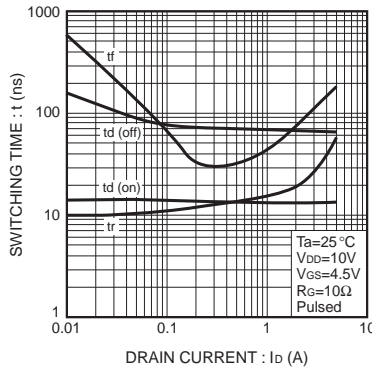

Fig.2 Switching Characteristics

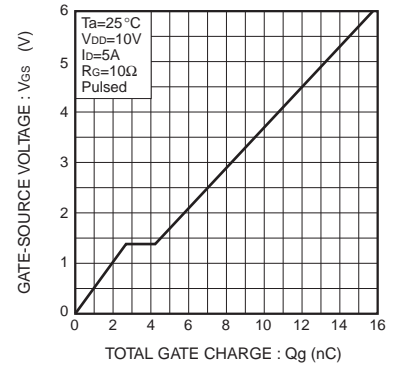

Fig.3 Dynamic Input Characteristics

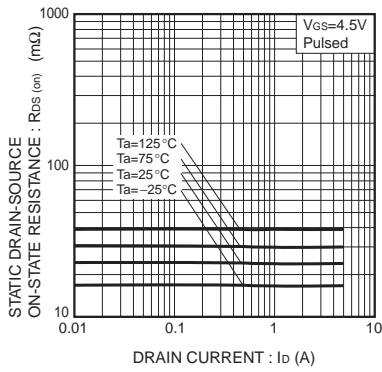

Fig.7 Static Drain-Source On-State Resistance vs. Drain current (I)

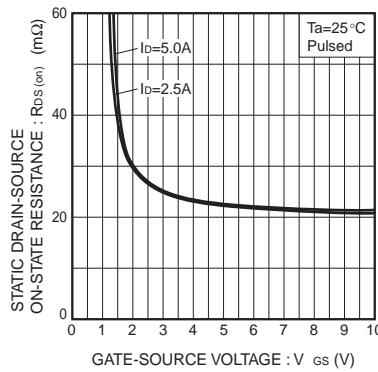

Fig.5 Static Drain-Source On-State Resistance vs. Gate-Source Voltage

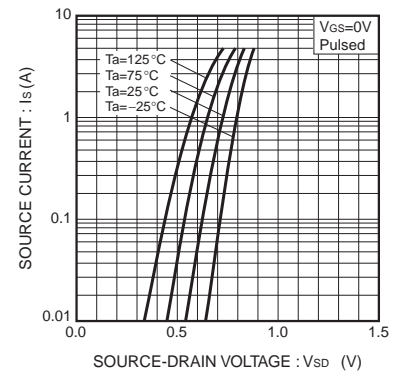

Fig.6 Source Current vs. Source-Drain Voltage

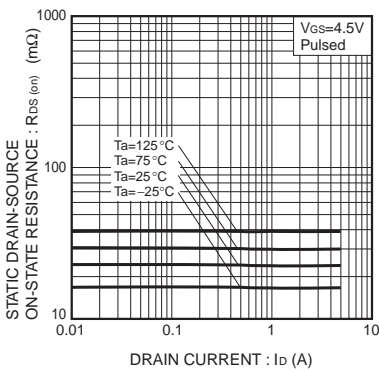

Fig.7 Static Drain-Source On-State Resistance vs. Drain current (I)

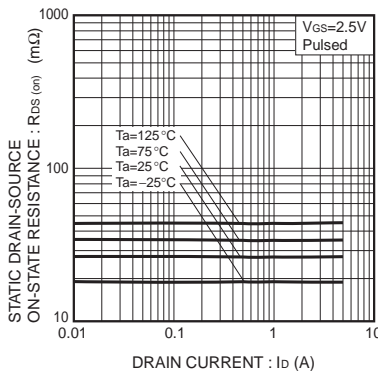

Fig.8 Static Drain-Source On-State Resistance vs. Drain current (II)

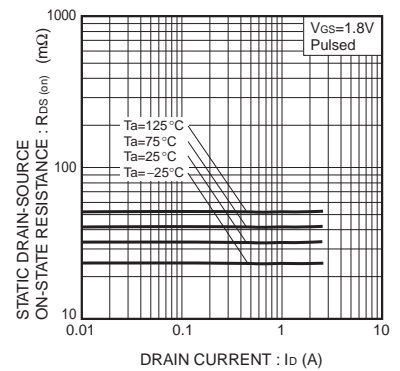

Fig.9 Static Drain-Source On-State Resistance vs. Drain current (III)

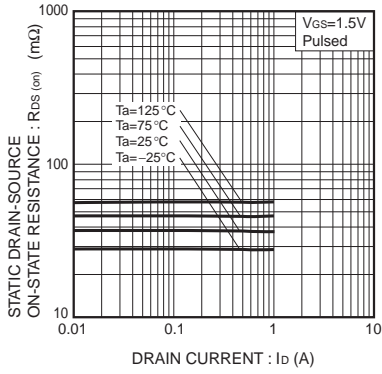

Fig.10 Static Drain-Source On-State Resistance vs. Drain current (IV)

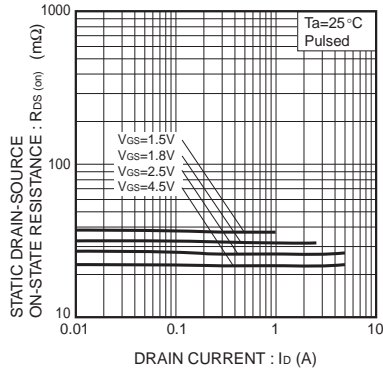

Fig.11 Static Drain-Source On-State Resistance vs. Drain current (V)

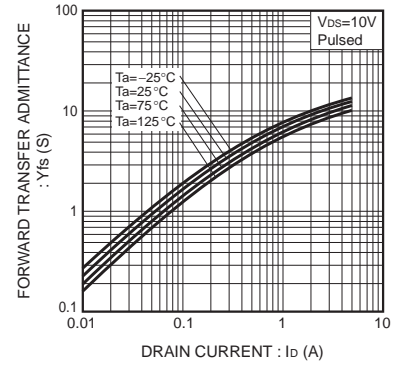

Fig.12 Forward Transfer Admittance vs. Drain current

● Measurement circuit

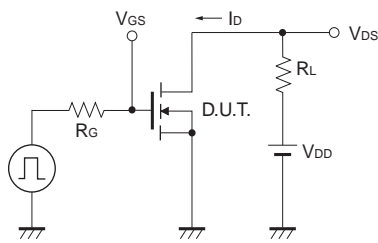

Fig.13 Switching Time Measurement Circuit

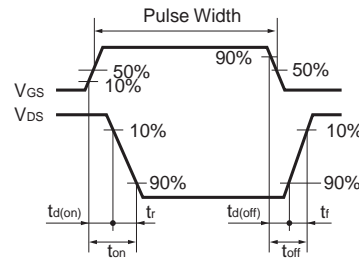

Fig.14 Switching Waveforms

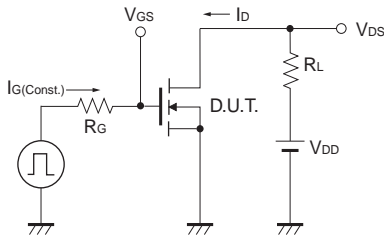

Fig.15 Gate Charge Measurement Circuit

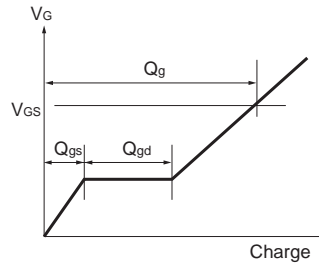

Fig.16 Gate Charge Waveform

Notes

- 1) The information contained herein is subject to change without notice.
- 2) Before you use our Products, please contact our sales representative and verify the latest specifications :
- 3) Although ROHM is continuously working to improve product reliability and quality, semiconductors can break down and malfunction due to various factors.
Therefore, in order to prevent personal injury or fire arising from failure, please take safety measures such as complying with the derating characteristics, implementing redundant and fire prevention designs, and utilizing backups and fail-safe procedures. ROHM shall have no responsibility for any damages arising out of the use of our Products beyond the rating specified by ROHM.
- 4) Examples of application circuits, circuit constants and any other information contained herein are provided only to illustrate the standard usage and operations of the Products. The peripheral conditions must be taken into account when designing circuits for mass production.
- 5) The technical information specified herein is intended only to show the typical functions of and examples of application circuits for the Products. ROHM does not grant you, explicitly or implicitly, any license to use or exercise intellectual property or other rights held by ROHM or any other parties. ROHM shall have no responsibility whatsoever for any dispute arising out of the use of such technical information.
- 6) The Products are intended for use in general electronic equipment (i.e. AV/OA devices, communication, consumer systems, gaming/entertainment sets) as well as the applications indicated in this document.
- 7) The Products specified in this document are not designed to be radiation tolerant.
- 8) For use of our Products in applications requiring a high degree of reliability (as exemplified below), please contact and consult with a ROHM representative : transportation equipment (i.e. cars, ships, trains), primary communication equipment, traffic lights, fire/crime prevention, safety equipment, medical systems, servers, solar cells, and power transmission systems.
- 9) Do not use our Products in applications requiring extremely high reliability, such as aerospace equipment, nuclear power control systems, and submarine repeaters.
- 10) ROHM shall have no responsibility for any damages or injury arising from non-compliance with the recommended usage conditions and specifications contained herein.
- 11) ROHM has used reasonable care to ensure the accuracy of the information contained in this document. However, ROHM does not warrant that such information is error-free, and ROHM shall have no responsibility for any damages arising from any inaccuracy or misprint of such information.
- 12) Please use the Products in accordance with any applicable environmental laws and regulations, such as the RoHS Directive. For more details, including RoHS compatibility, please contact a ROHM sales office. ROHM shall have no responsibility for any damages or losses resulting from non-compliance with any applicable laws or regulations.
- 13) When providing our Products and technologies contained in this document to other countries, you must abide by the procedures and provisions stipulated in all applicable export laws and regulations, including without limitation the US Export Administration Regulations and the Foreign Exchange and Foreign Trade Act.
- 14) This document, in part or in whole, may not be reprinted or reproduced without prior consent of ROHM.



Thank you for your accessing to ROHM product informations.
More detail product informations and catalogs are available, please contact us.

ROHM Customer Support System

<http://www.rohm.com/contact/>

Mouser Electronics

Authorized Distributor

Click to View Pricing, Inventory, Delivery & Lifecycle Information:

[ROHM Semiconductor:](#)

[RQ6C050UNTR](#)