

## Automotive TVS for load dump protection

Datasheet - production data

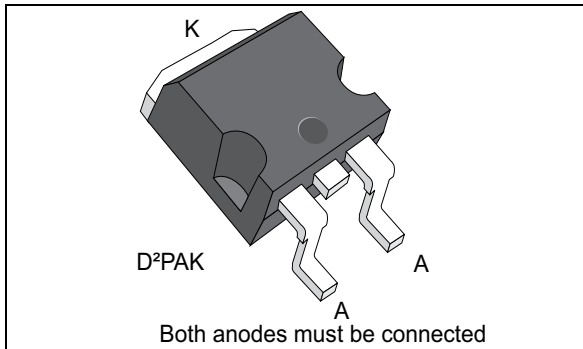

### Description

The LDP01-xxAY Transil™ series have been designed to protect automotive sensitive circuits against surges defined in ISO 7637-2 and ISO 16750 tests A and B also called load-dump.

The planar technology makes it compatible with high-end circuits where low leakage current and high junction temperature are required to provide reliability and stability over time.

LDP01-xxAY is packaged in D<sup>2</sup>PAK.

### Features

- Stand-off voltage range: from 22 to 70 V
- Low leakage current: 1  $\mu$ A at 25 °C
- Operating  $T_j$  max: 175 °C
- High power capability at  $T_j$  max
- JEDEC registered package outline
- ROHS and Halogen free
- Resin meets UL 94, V0
- AEC-Q101 compliant

### Complies with the following standards:

- IEC 61000-4-2 exceeds level 4
  - 30 kV (air discharge)
  - 30 kV (contact discharge)
- ISO10605 – C = 330 pF, R = 330  $\Omega$ 
  - 30 kV (air discharge)
  - 30 kV (contact discharge)
- ISO 7637-2
  - Pulse 1:  $V_S = -150$  V
  - Pulse 2a:  $V_S = +112$  V
  - Pulse 3a:  $V_S = -220$  V
  - Pulse 3b:  $V_S = +150$  V
  - Formerly pulses 5a and 5b
- ISO 16750-2
  - Tests A and B

Table 1. Device summary

Part number	Breakdown voltage ( $V_{BR}$ at $I_R = 1$ mA)		
	min.	typ.	max.
	V		
LDP01-26AY	24.4	26	27.0
LDP01-28AY	26.7	28	29.5
LDP01-30AY	28.9	30	31.9
LDP01-33AY	31.1	33	34.3
LDP01-35AY	33.3	35	36.9
LDP01-39AY	36.7	39	40.5
LDP01-42AY	40	42	44.2
LDP01-47AY	44.4	47	49
LDP01-50AY	47.8	50	52.8
LDP01-56AY	53.3	56	58.9
LDP01-68AY	64.4	68	71.2
LDP01-82AY	77.8	82	86

# 1 Characteristics

**Table 2. Absolute maximum ratings ( $T_{amb} = 25\text{ }^{\circ}\text{C}$ )**

Symbol	Parameter	Value	Unit	
$V_{PP}$	Peak pulse voltage	ISO 10605 (C = 330 pF, R = 330 $\Omega$ )	kV	
		- contact discharge		30
		- air discharge		30
		IEC 61000-4-2		
		- contact discharge	30	
		- air discharge	30	
$T_{stg}$	Storage temperature range	-65 to + 175	$^{\circ}\text{C}$	
$T_j$	Operating junction temperature range	-55 to + 175	$^{\circ}\text{C}$	
$T_L$	Maximum lead temperature for soldering during 10 s	260	$^{\circ}\text{C}$	

**Table 3. Thermal parameter**

Symbol	Parameter	Maximum	Unit
$R_{th(j-c)}$	Junction to case	0.24	$^{\circ}\text{C/W}$
	D <sup>2</sup> PAK		

**Figure 1. Electrical characteristics (definitions)**

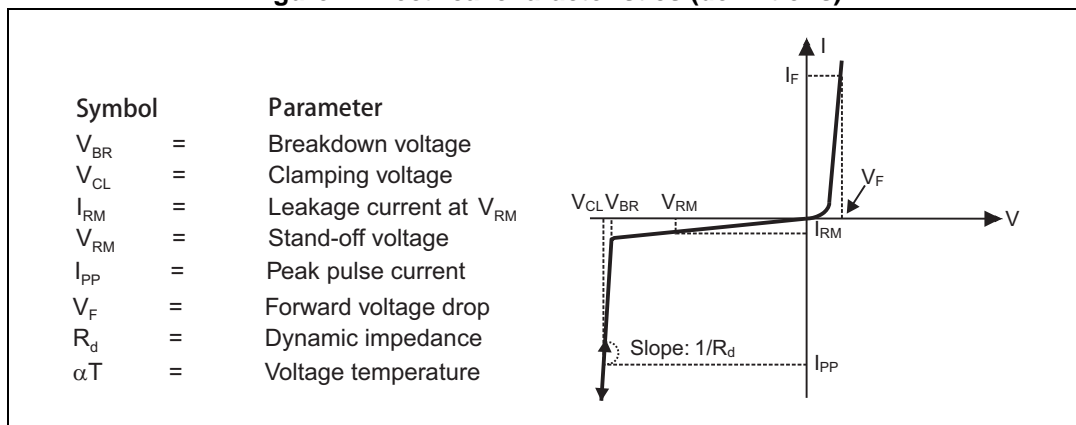

**Figure 2. Pulse definition for electrical characteristics**

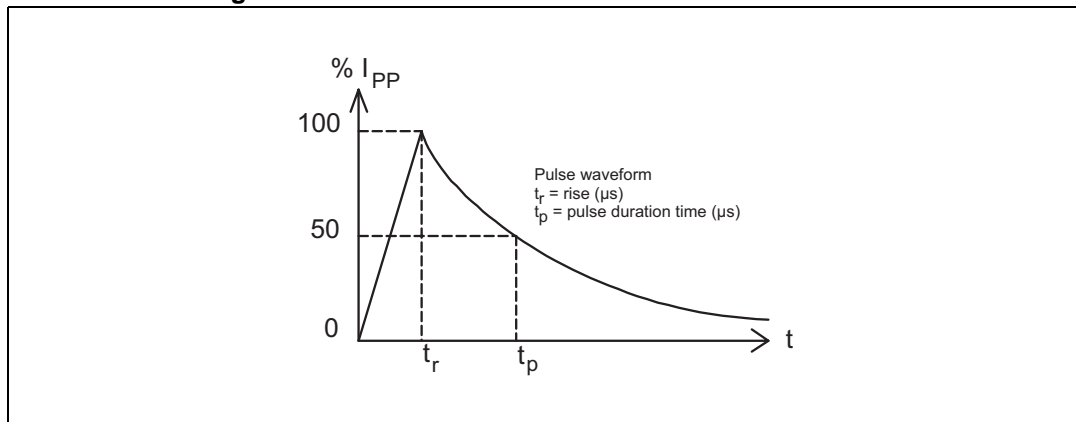

Table 4. Electrical characteristics (parameter)

Order code	I <sub>RM</sub> max. at V <sub>RM</sub>		V <sub>BR</sub> at I <sub>R</sub> <sup>(1)</sup>				V <sub>CL</sub> at I <sub>PP</sub> 10/1000 μs		R <sub>D</sub> <sup>(2)</sup> 10/1000 μs	V <sub>CL</sub> at I <sub>PP</sub> 8/20 μs		R <sub>D</sub> <sup>(2)</sup> 8/20 μs	α T <sup>(3)</sup>	
	25 °C	175 °C	min.	typ.	max.	max.	max.	max.			max.			
	μA	V	V		mA	V	A	m Ω	V	A	m Ω	10 <sup>-4</sup> /°C		
LDP01-26AY	1	100	22	24.4	26	27.0	1	36	140	64	42	1400	11	9.6
LDP01-28AY	1	100	24	26.7	28	29.5	1	40	120	88	45	1250	12	9.7
LDP01-30AY	1	100	27	28.9	30	31.9	1	40	125	65	49	1400	12	9.7
LDP01-33AY	1	100	28	31.1	33	34.3	1	43.5	110	75	56	1250	17	9.8
LDP01-35AY	1	100	30	33.3	35	36.9	1	45.5	95	91	60	1150	20	9.9
LDP01-39AY	1	100	33	36.7	39	40.5	1	51.5	85	129	66	1050	24	10
LDP01-42AY	1	100	36	40	42	44.2	1	57	77	166	71	1000	27	10
LDP01-47AY	1	100	40	44.4	47	49	1	63	65	215	76.5	950	29	10.1
LDP01-50AY	1	100	43	47.8	50	52.8	1	68	55	276	81	900	31	10.2
LDP01-56AY	1	100	48	53.3	56	58.9	1	76	48	356	90	770	40	10.3
LDP01-68AY	1	100	58	64.4	68	71.2	1	92	42	495	110	620	63	10.4
LDP01-82AY	1	100	70	77.8	82	86	1	113	35	771	135	550	89	10.5

1. Pulse test: t<sub>p</sub> < 50 ms
2. To calculate maximum clamping voltage at other surge level, use the following formula: V<sub>CL</sub>max = R<sub>D</sub> × I<sub>PP</sub> + V<sub>BR</sub>max
3. To calculate V<sub>BR</sub> or V<sub>CL</sub> versus junction temperature, use the following formulas:  
 $V_{BR} \text{ at } T_j = V_{BR} \text{ at } 25 \text{ °C} \times (1 + \alpha T \times (T_j - 25))$   
 $V_{CL} \text{ at } T_j = V_{CL} \text{ at } 25 \text{ °C} \times (1 + \alpha T \times (T_j - 25))$

Figure 3. Peak pulse power dissipation versus initial junction temperature (LDP01-30AY)

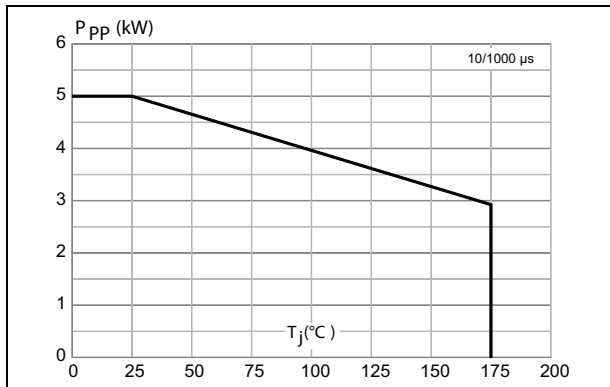

Figure 4. Peak pulse power versus exponential pulse duration (LDP01-30AY)

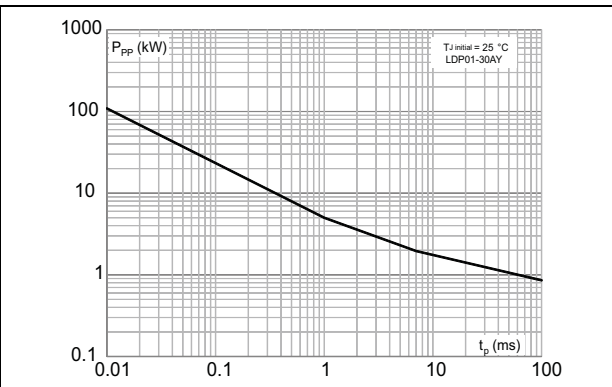

Figure 5. ISO7637-2, pulse 5a definition

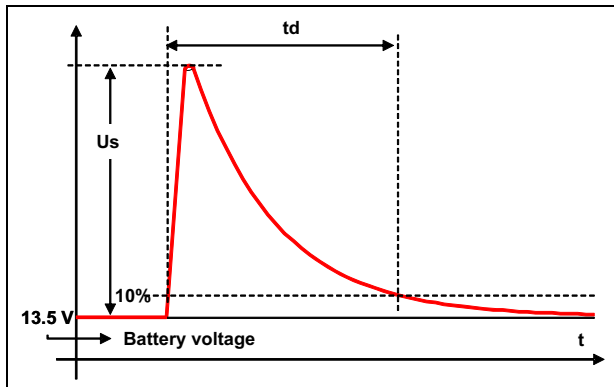

Figure 6. Load dump capability (LDP01-30AY)  
 $U_s = f(R_i)$  pulse 5a)

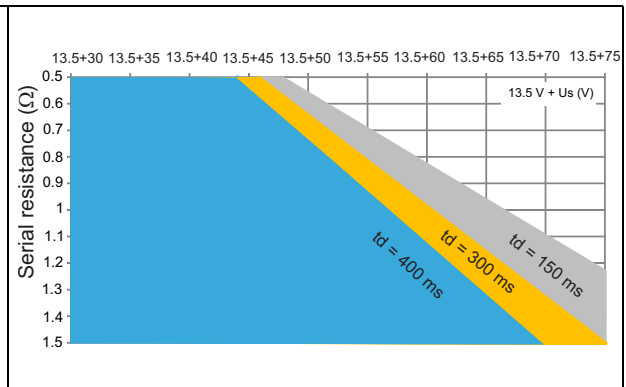

Figure 7. ISO7637-2, pulse 5b definition

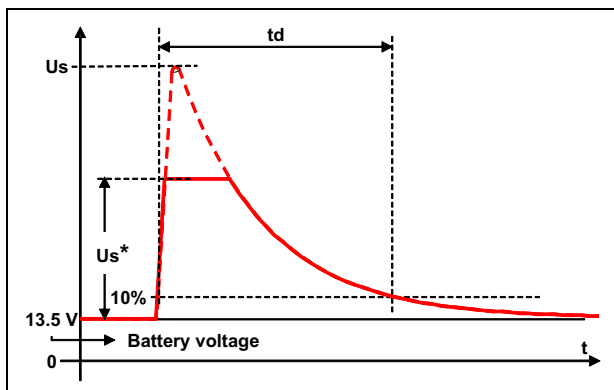

Figure 8. Load dump capability (LDP01-30AY)  
 $U_s^* = f(R_i)$  pulse 5b,  $U_s = 87 V$

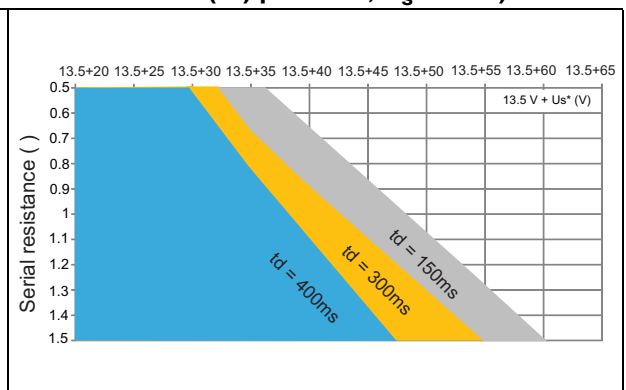

Figure 9. ISO 16750-2, test A definition

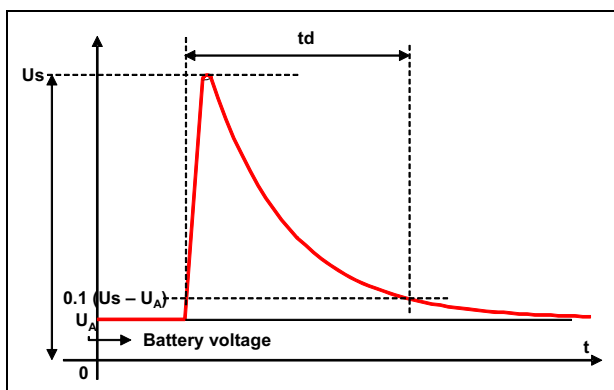

Figure 10. Load dump capability (LDP01-30AY)  
 $U_s = f(R_i)$ , Test A

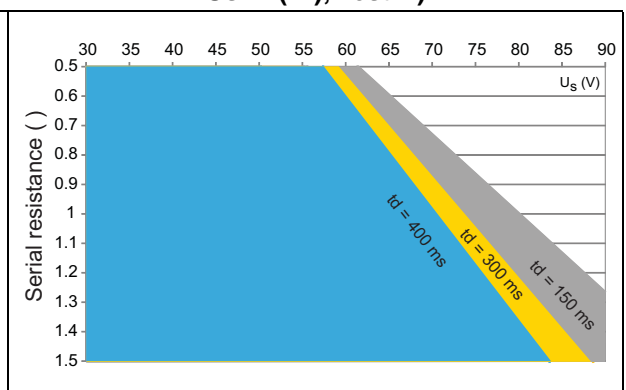

Figure 11. ISO 16750-2, test B definition

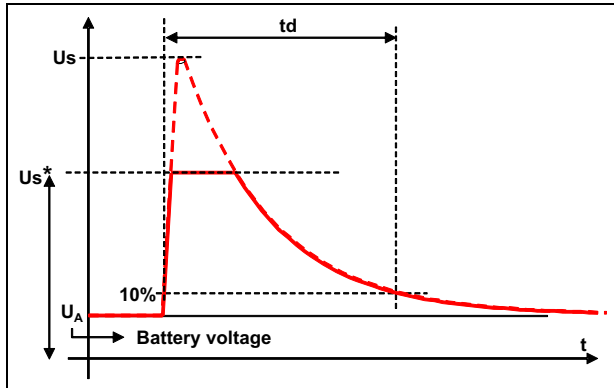

Figure 12. Load dump capability (LDP01-30AY)  $U_s^* = f(R_i)$  Test B,  $U_s = 87\text{ V}$

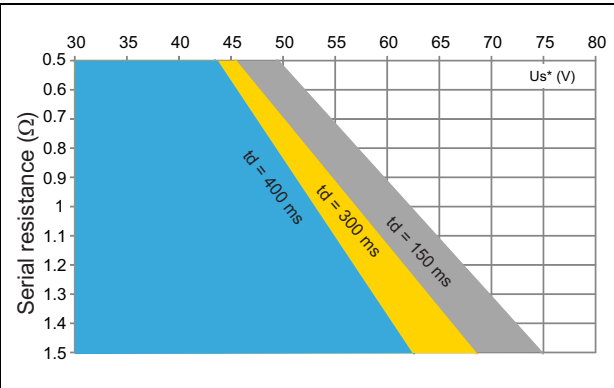

Figure 13. Clamping voltage versus peak pulse current (maximum values)

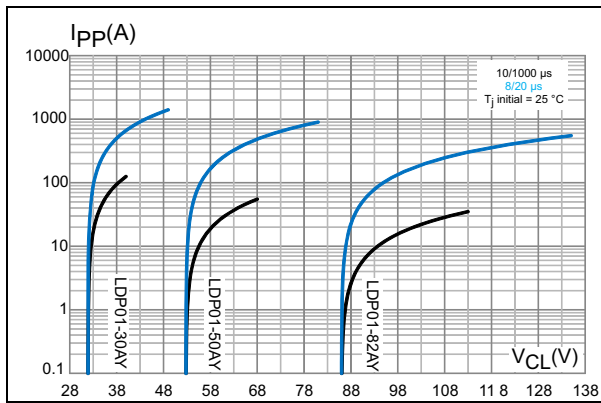

Figure 14. ISO 16750-2 test B response ( $U_A + U_s^* = 13.5 + 30\text{ V}$ ,  $U_s = 87\text{ V}$ ,  $t_d = 400\text{ ms}$ ,  $R_i = 0.5\ \Omega$ )

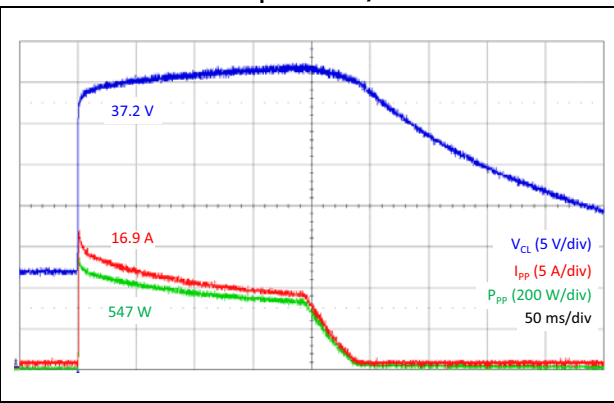

Figure 15. Peak forward voltage versus peak forward current (typical values)

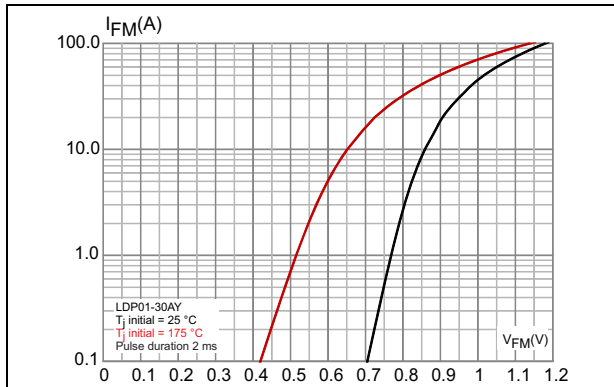

Figure 16. Leakage current versus junction temperature (typical values)

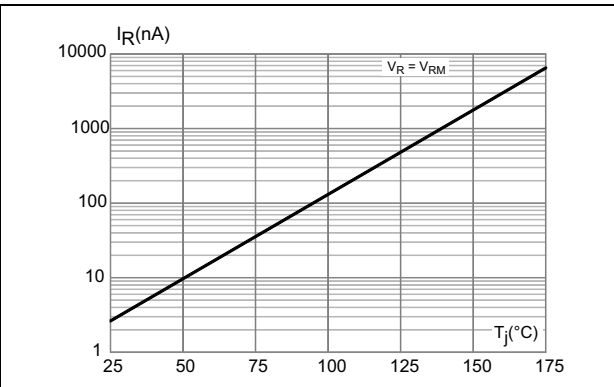
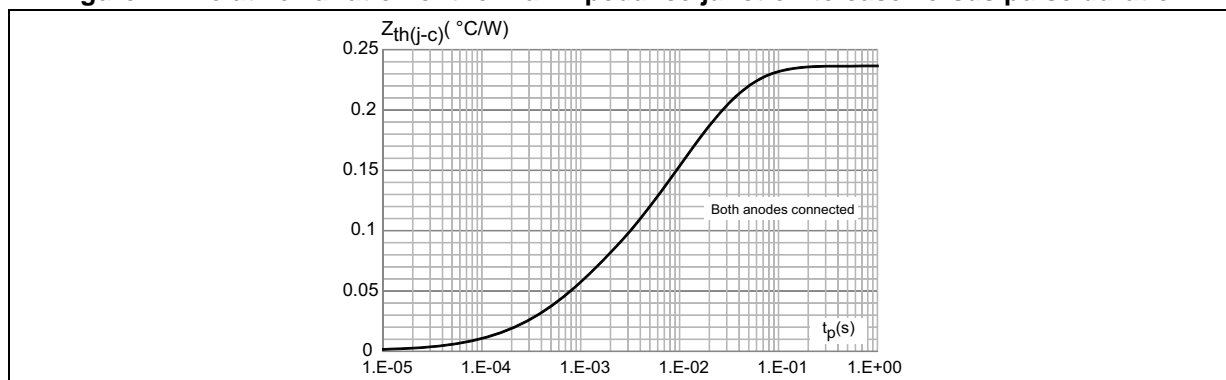

Figure 17. Relative variation of thermal impedance junction to case versus pulse duration



More information available in AN2689 on [www.st.com](http://www.st.com): Protection of automotive electronics from electrical hazards, guidelines for design and component selection.

## 2 Package information

- Epoxy meets UL94, V0

In order to meet environmental requirements, ST offers these devices in different grades of ECOPACK<sup>®</sup> packages, depending on their level of environmental compliance. ECOPACK<sup>®</sup> specifications, grade definitions and product status are available at: [www.st.com](http://www.st.com). ECOPACK<sup>®</sup> is an ST trademark.

Figure 18. D<sup>2</sup>PAK dimension definitions

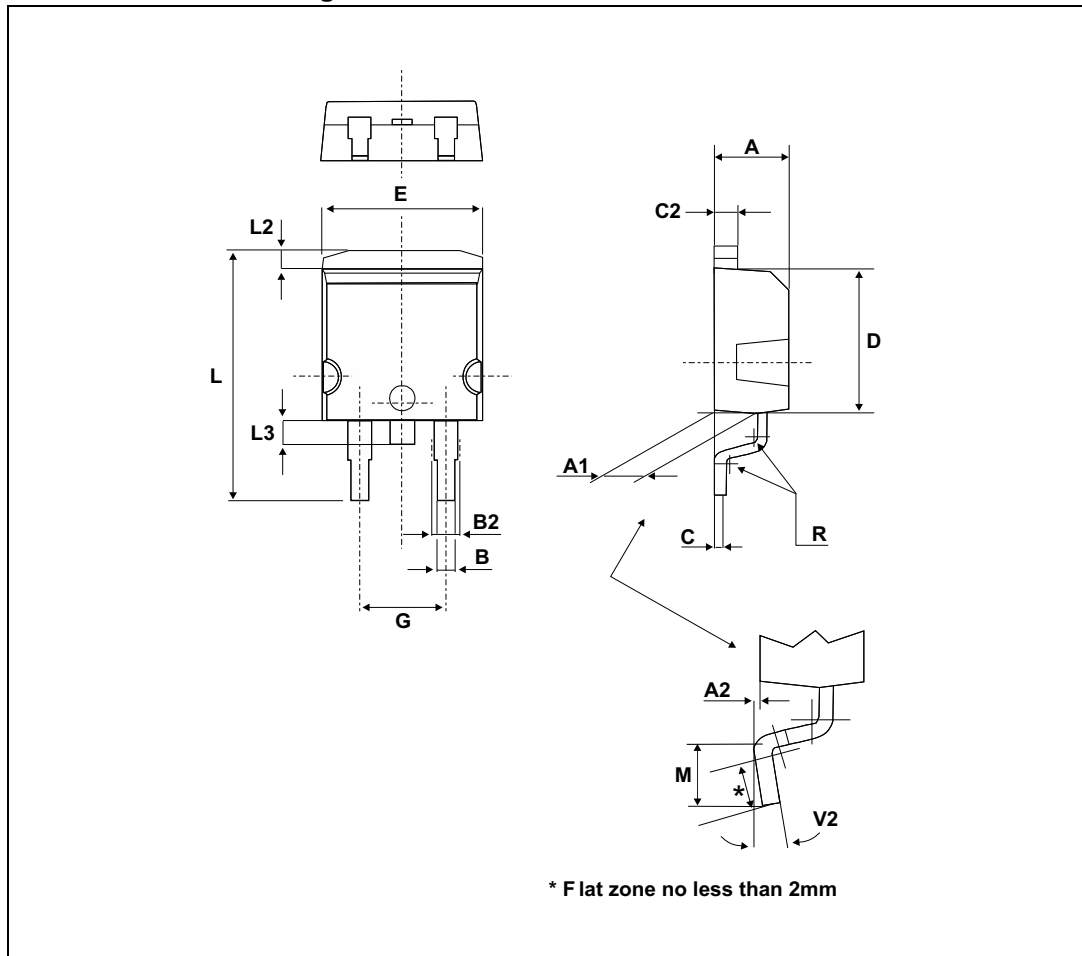

Table 5. D<sup>2</sup>PAK dimension values

Ref.	Dimensions			
	Millimeters		Inches	
	Min.	Max.	Min.	Max.
A	4.40	4.60	0.173	0.181
A1	2.49	2.69	0.098	0.106
A2	0.03	0.23	0.001	0.009
B	0.70	0.93	0.027	0.037
B2	1.14	1.70	0.045	0.067
C	0.45	0.60	0.017	0.024
C2	1.23	1.36	0.048	0.054
D	8.95	9.35	0.352	0.368
E	10.00	10.40	0.393	0.409
G	4.88	5.28	0.192	0.208
L	15.00	15.85	0.590	0.624
L2	1.27	1.40	0.050	0.055
L3	1.30	1.75	0.051	0.069
M	2.29	2.79	0.090	0.110
R	0.40 typ.		0.016 typ.	
V2	0°	8°	0°	8°

Figure 19. Footprint (dimensions in mm)

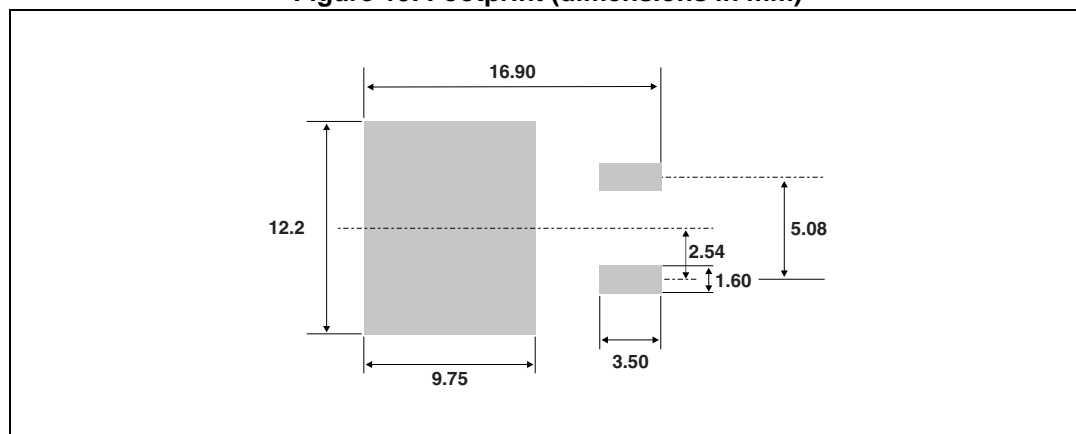
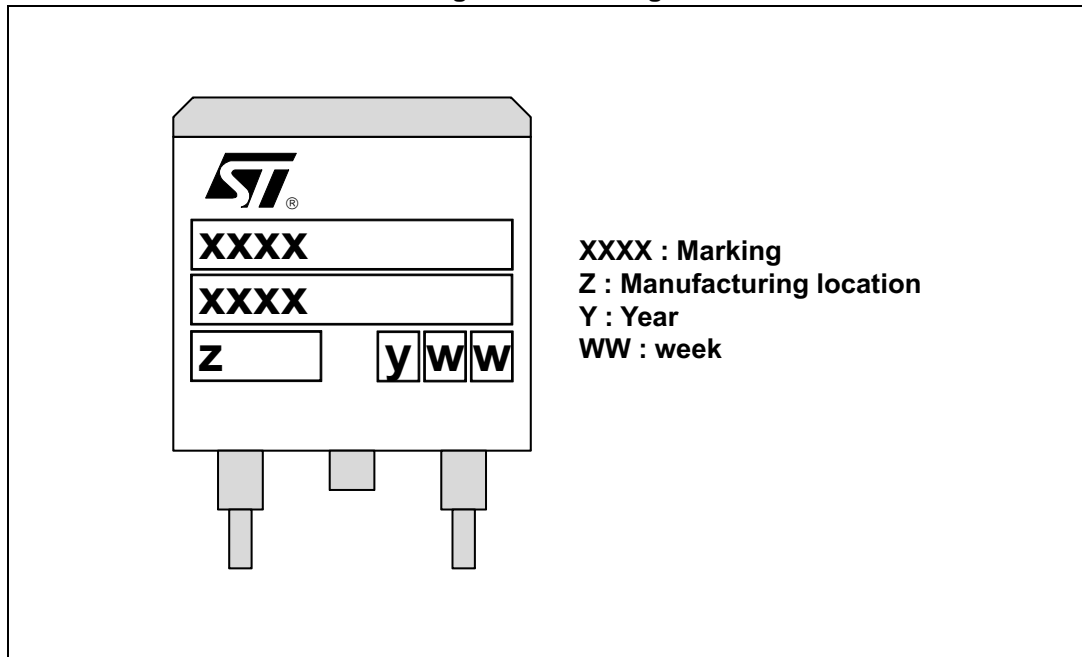



Figure 20. Marking



### 3 Ordering information

Table 6. Ordering information

Order code	Marking	Package	Weight	Base qty	Delivery mode
LDP01-26AY	LDP01-26AY	D <sup>2</sup> PAK	1.38 g	1000	Tape and reel
LDP01-28AY	LDP01-28AY				
LDP01-30AY	LDP01-30AY				
LDP01-33AY	LDP01-33AY				
LDP01-35AY	LDP01-35AY				
LDP01-39AY	LDP01-39AY				
LDP01-42AY	LDP01-42AY				
LDP01-47AY	LDP01-47AY				
LDP01-50AY	LDP01-50AY				
LDP01-56AY	LDP01-56AY				
LDP01-68AY	LDP01-68AY				
LDP01-82AY	LDP01-82AY				

### 4 Revision history

Table 7. Document revision history

Date	Revision	Changes
26-Nov-2014	1	Initial release.
01-Oct-2015	2	Added wildcard character in part number on the cover page. Updated <a href="#">Figure 4</a> . Minor text changes.

**IMPORTANT NOTICE – PLEASE READ CAREFULLY**

STMicroelectronics NV and its subsidiaries ("ST") reserve the right to make changes, corrections, enhancements, modifications, and improvements to ST products and/or to this document at any time without notice. Purchasers should obtain the latest relevant information on ST products before placing orders. ST products are sold pursuant to ST's terms and conditions of sale in place at the time of order acknowledgement.

Purchasers are solely responsible for the choice, selection, and use of ST products and ST assumes no liability for application assistance or the design of Purchasers' products.

No license, express or implied, to any intellectual property right is granted by ST herein.

Resale of ST products with provisions different from the information set forth herein shall void any warranty granted by ST for such product.

ST and the ST logo are trademarks of ST. All other product or service names are the property of their respective owners.

Information in this document supersedes and replaces information previously supplied in any prior versions of this document.

© 2015 STMicroelectronics – All rights reserved



# Mouser Electronics

Authorized Distributor

Click to View Pricing, Inventory, Delivery & Lifecycle Information:

## STMicroelectronics:

[LDP01-35AY](#) [LDP01-50AY](#) [LDP01-28AY](#) [LDP01-39AY](#) [LDP01-42AY](#) [LDP01-82AY](#) [LDP01-47AY](#) [LDP01-33AY](#)  
[LDP01-26AY](#) [LDP01-56AY](#) [LDP01-30AY](#) [LDP01-68AY](#)