



STB40NF10L

N-channel 100V - 0.028Ω - 40A - D²PAK
Low gate charge STripFET™ II Power MOSFET

General features

Type	V _{DSS}	R _{DS(on)}	I _D
STB40NF10L	100V	<0.033Ω	40A

- Exceptional dv/dt capability
- 100% avalanche tested
- Application oriented characterization

Description

This Power MOSFET series realized with STMicroelectronics unique STripFET process has specifically been designed to minimize input capacitance and gate charge. It is therefore suitable as primary switch in advanced high-efficiency isolated DC-DC converters for Telecom and Computer application. It is also intended for any application with low gate charge drive requirements.

Applications

- Switching application

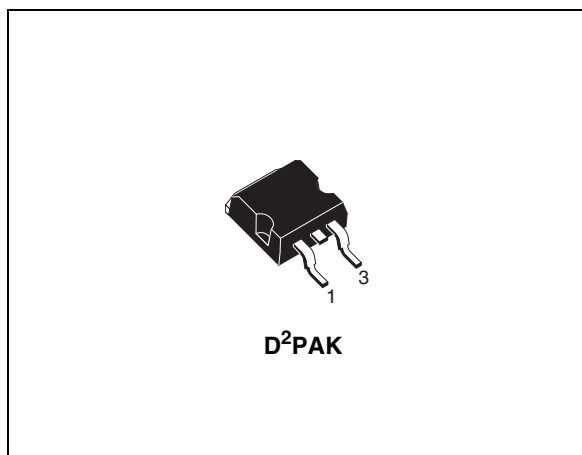

Internal schematic diagram

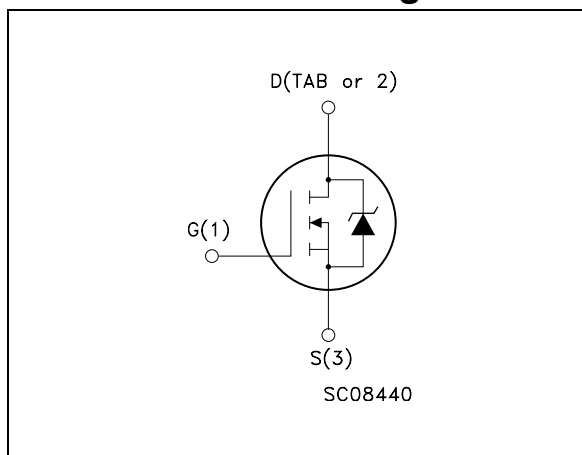

Order codes

Part number	Marking	Package	Packaging
STB40NF10L	B40NF10L	D ² PAK	Tape & reel

Contents

1	Electrical ratings	3
2	Electrical characteristics	4
	2.1 Electrical characteristics (curves)	6
3	Test circuit	8
4	Package mechanical data	9
5	Packing mechanical data	11
6	Revision history	12

1 Electrical ratings

Table 1. Absolute maximum ratings

Symbol	Parameter	Value	Unit
V_{DS}	Drain-source voltage ($V_{GS} = 0$)	100	V
V_{DGR}	Drain-gate voltage ($R_{GS} = 20\text{ k}\Omega$)	100	V
V_{GS}	Gate- source voltage	± 15	V
I_D	Drain current (continuous) at $T_C = 25^\circ\text{C}$	40	A
I_D	Drain current (continuous) at $T_C = 100^\circ\text{C}$	25	A
$I_{DM}^{(1)}$	Drain current (pulsed)	160	A
P_{tot}	Total dissipation at $T_C = 25^\circ\text{C}$	150	W
	Derating Factor	1	W/ $^\circ\text{C}$
$E_{AS}^{(2)}$	Single pulse avalanche energy	430	mJ
T_{stg}	Storage temperature	-65 to 175	$^\circ\text{C}$
T_j	Max. operating junction temperature		

1. Pulse width limited by safe operating area.

2. Starting $T_j = 25^\circ\text{C}$, $I_D = 20\text{A}$, $V_{DD} = 40\text{V}$

Table 2. Thermal data

$R_{thj-case}$	Thermal resistance junction-case max	1	$^\circ\text{C}/\text{W}$
$R_{thj-amb}$	Thermal resistance junction-ambient max	62.5	$^\circ\text{C}/\text{W}$
T_J	Maximum lead temperature for soldering purpose	300	$^\circ\text{C}$

2 Electrical characteristics

($T_{CASE}=25^{\circ}C$ unless otherwise specified)

Table 3. On/off states

Symbol	Parameter	Test conditions	Min.	Typ.	Max.	Unit
$V_{(BR)DSS}$	Drain-source breakdown voltage	$I_D = 250\mu A, V_{GS} = 0$	100			V
I_{DSS}	Zero gate voltage drain current ($V_{GS} = 0$)	$V_{DS} = \text{Max rating}$ $V_{DS} = \text{Max rating},$ $T_C = 125^{\circ}C$			1 10	μA μA
I_{GSS}	Gate-body leakage current ($V_{DS} = 0$)	$V_{GS} = \pm 20V$			± 100	nA
$V_{GS(th)}$	Gate threshold voltage	$V_{DS} = V_{GS}, I_D = 250\mu A$	1	1.7	2.5	V
$R_{DS(on)}$	Static drain-source on resistance	$V_{GS} = 10V, I_D = 20A$ $V_{GS} = 5V, I_D = 20A$		0.028 0.030	0.033 0.036	Ω Ω

Table 4. Dynamic

Symbol	Parameter	Test conditions	Min.	Typ.	Max.	Unit
$g_{fs}^{(1)}$	Forward transconductance	$V_{DS} = 15V, I_D = 20A$		25		S
C_{iss}	Input capacitance	$V_{DS} = 25V, f = 1MHz,$ $V_{GS} = 0$		2300		pF
C_{oss}	Output capacitance			290		pF
C_{rss}	Reverse transfer capacitance			125		pF
$t_{d(on)}$	Turn-on delay time	$V_{DD} = 50V, I_D = 20A$ $R_G = 4.7\Omega, V_{GS} = 4.5V$ (see Figure 13)		25		ns
t_r	Rise time			82		ns
$t_{d(off)}$	Turn-off delay time			64		ns
t_f	Fall time			24		ns
Q_g	Total gate charge	$V_{DD} = 80V, I_D = 40A,$ $V_{GS} = 4.5V, R_G = 4.7\Omega$ (see Figure 14)		46	64	nC
Q_{gs}	Gate-source charge			12		nC
Q_{gd}	Gate-drain charge			22		nC

1. Pulsed: Pulse duration = 300 μs , duty cycle 1.5 %.

Table 5. Source drain diode

Symbol	Parameter	Test conditions	Min.	Typ.	Max.	Unit
I_{SD} $I_{SDM}^{(1)}$	Source-drain current Source-drain current (pulsed)				40 160	A A
$V_{SD}^{(2)}$	Forward on voltage	$I_{SD} = 40A, V_{GS} = 0$			1.3	V
t_{rr} Q_{rr} I_{RRM}	Reverse recovery time Reverse recovery charge Reverse recovery current	$I_{SD} = 40A, di/dt = 100A/\mu s,$ $V_{DD} = 30V, T_j = 150^\circ C$ (see Figure 15)		110 467 8		ns nC A

1. Pulse width limited by safe operating area.
2. Pulsed: Pulse duration = 300 μs , duty cycle 1.5 %

2.1 Electrical characteristics (curves)

Figure 1. Safe operating area

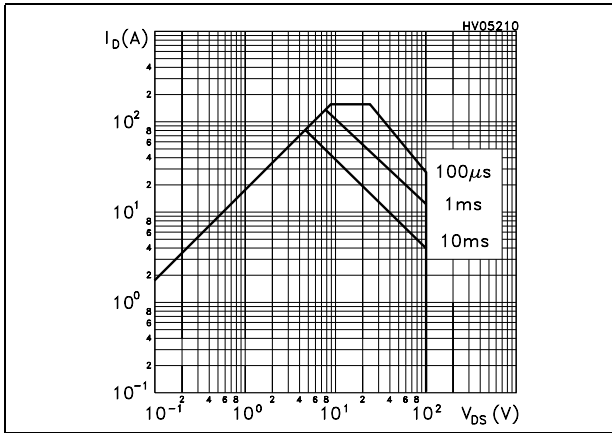

Figure 2. Thermal impedance

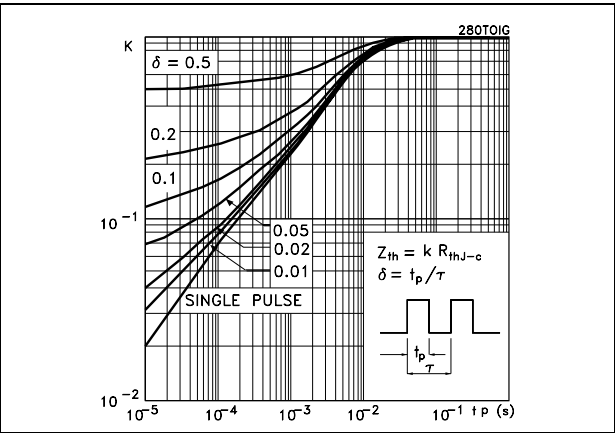

Figure 3. Output characteristics

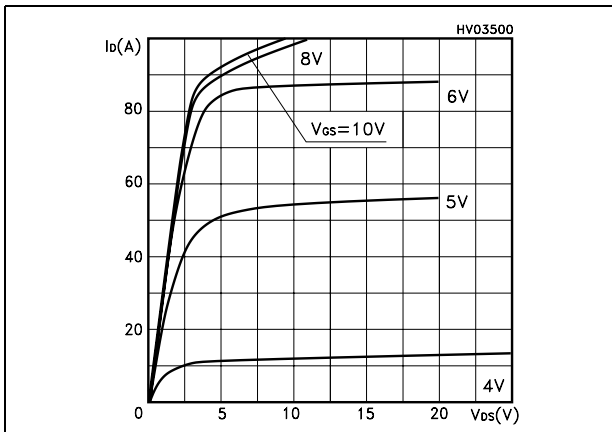

Figure 4. Transfer characteristics

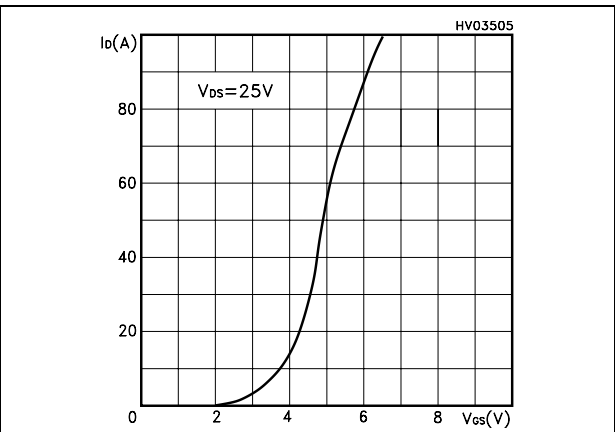

Figure 5. Transconductance

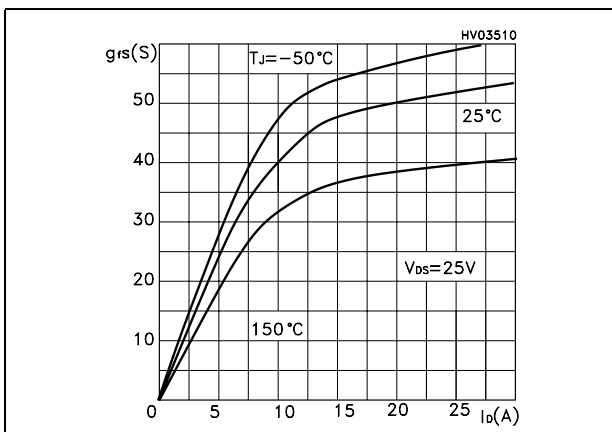

Figure 6. Static drain-source on resistance

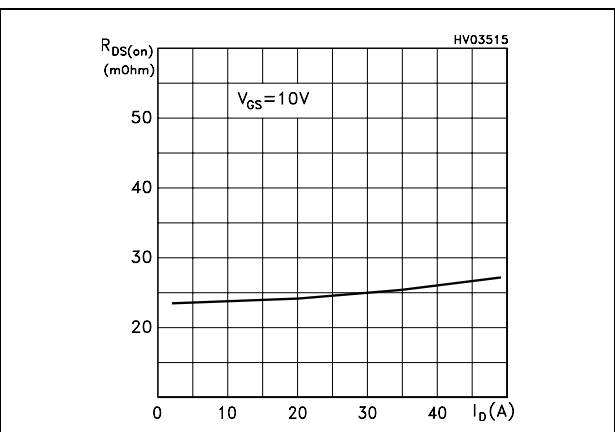

Figure 7. Gate charge vs gate-source voltage Figure 8. Capacitance variations

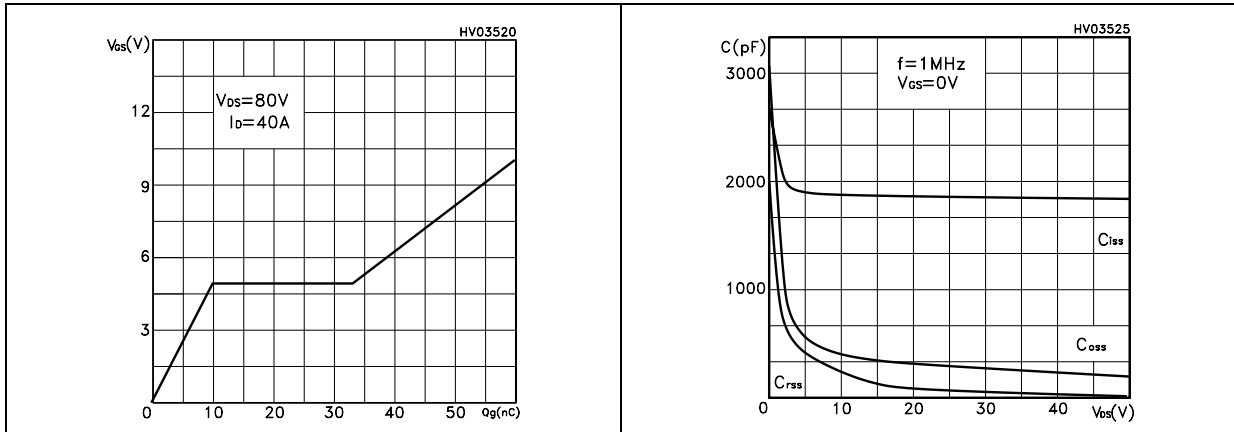

Figure 9. Normalized gate threshold voltage vs temperature Figure 10. Normalized on resistance vs temperature

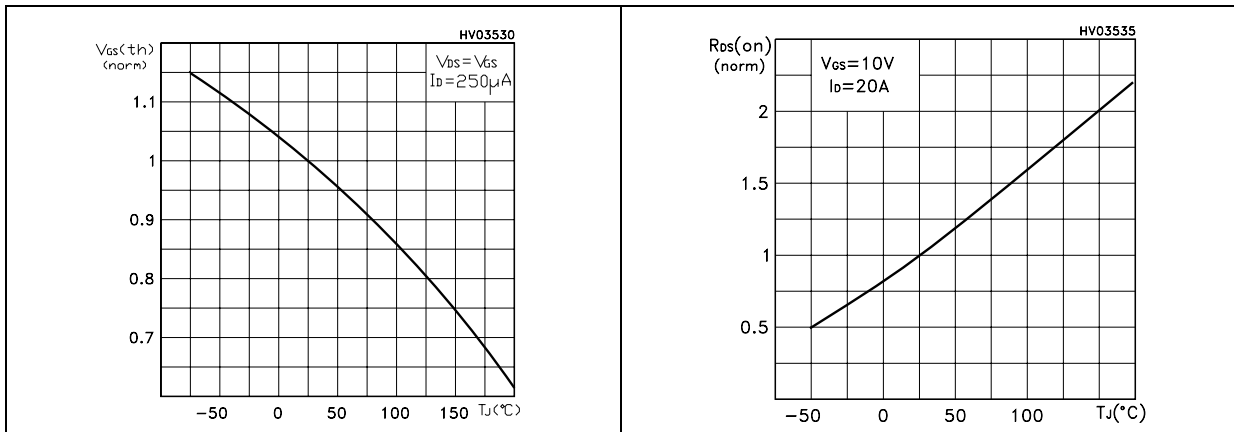
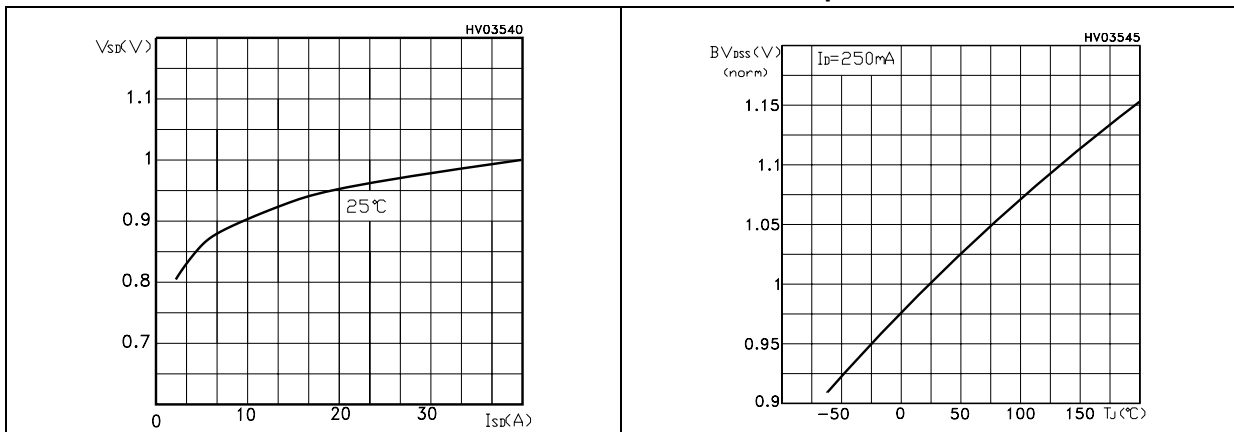

Figure 11. Source-drain diode forward characteristics Figure 12. Normalized breakdown voltage vs temperature



3 Test circuit

Figure 13. Switching times test circuit for resistive load



Figure 14. Gate charge test circuit



Figure 15. Test circuit for inductive load switching and diode recovery times



Figure 16. Unclamped Inductive load test circuit

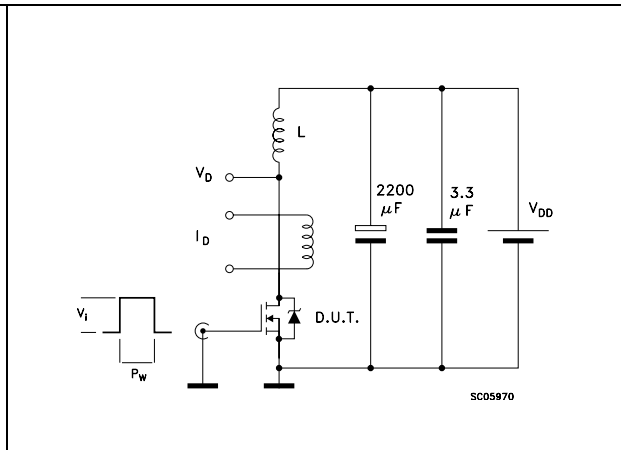
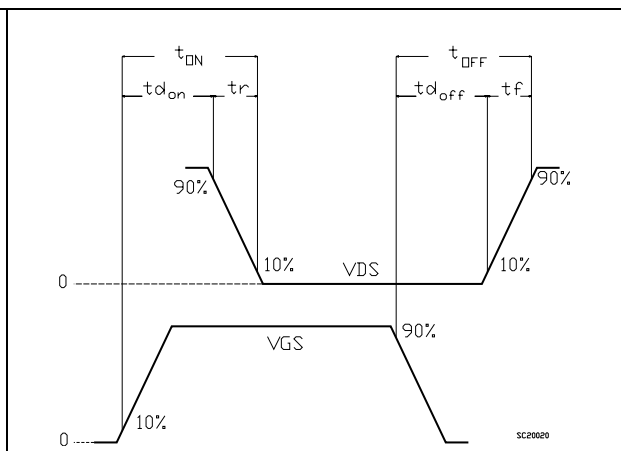

Figure 17. Unclamped inductive waveform



Figure 18. Switching time waveform



4 Package mechanical data

In order to meet environmental requirements, ST offers these devices in ECOPACK® packages. These packages have a Lead-free second level interconnect . The category of second level interconnect is marked on the package and on the inner box label, in compliance with JEDEC Standard JESD97. The maximum ratings related to soldering conditions are also marked on the inner box label. ECOPACK is an ST trademark. ECOPACK specifications are available at: www.st.com

D²PAK MECHANICAL DATA

DIM.	mm.			inch		
	MIN.	TYP.	MAX.	MIN.	TYP.	MAX.
A	4.4		4.6	0.173		0.181
A1	2.49		2.69	0.098		0.106
A2	0.03		0.23	0.001		0.009
B	0.7		0.93	0.027		0.036
B2	1.14		1.7	0.044		0.067
C	0.45		0.6	0.017		0.023
C2	1.23		1.36	0.048		0.053
D	8.95		9.35	0.352		0.368
D1		8			0.315	
E	10		10.4	0.393		
E1		8.5			0.334	
G	4.88		5.28	0.192		0.208
L	15		15.85	0.590		0.625
L2	1.27		1.4	0.050		0.055
L3	1.4		1.75	0.055		0.068
M	2.4		3.2	0.094		0.126
R		0.4			0.015	
V2	0°		4°			

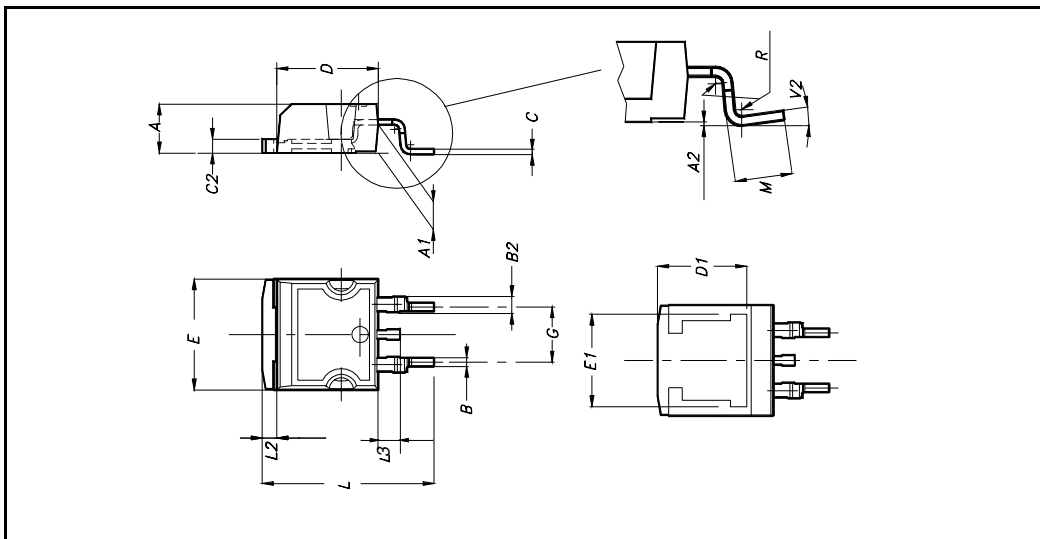

5 Packing mechanical data

D²PAK FOOTPRINT

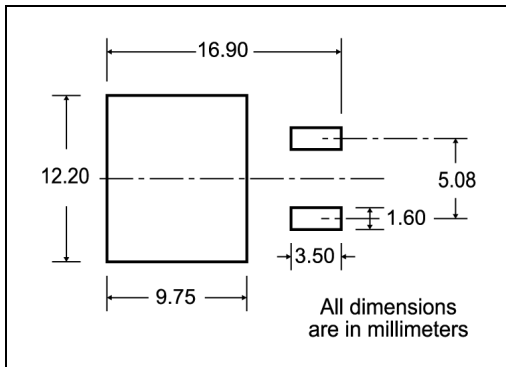

TAPE AND REEL SHIPMENT

40 mm min. Access hole at slot location

Full radius

Tape slot in core for tape start 2.5mm min. width

TAPE MECHANICAL DATA

DIM.	mm		inch	
	MIN.	MAX.	MIN.	MAX.
A0	10.5	10.7	0.413	0.421
B0	15.7	15.9	0.618	0.626
D	1.5	1.6	0.059	0.063
D1	1.59	1.61	0.062	0.063
E	1.65	1.85	0.065	0.073
F	11.4	11.6	0.449	0.456
K0	4.8	5.0	0.189	0.197
P0	3.9	4.1	0.153	0.161
P1	11.9	12.1	0.468	0.476
P2	1.9	2.1	0.075	0.082
R	50		1.574	
T	0.25	0.35	0.0098	0.0137
W	23.7	24.3	0.933	0.956

REEL MECHANICAL DATA

DIM.	mm		inch	
	MIN.	MAX.	MIN.	MAX.
A		330		12.992
B	1.5		0.059	
C	12.8	13.2	0.504	0.520
D	20.2		0.795	
G	24.4	26.4	0.960	1.039
N	100		3.937	
T		30.4		1.197

BASE QTY	BULK QTY
1000	1000

10 pitches cumulative tolerance on tape +/- 0.2 mm

Center line of cavity

User Direction of Feed

TRL

FEED DIRECTION

Bending radius R min.

* on sales type

6 Revision history

Table 6. Revision history

Date	Revision	Changes
21-Jun-2004	1	First release
26-Jun-2006	2	New template, no content change

Please Read Carefully:

Information in this document is provided solely in connection with ST products. STMicroelectronics NV and its subsidiaries ("ST") reserve the right to make changes, corrections, modifications or improvements, to this document, and the products and services described herein at any time, without notice.

All ST products are sold pursuant to ST's terms and conditions of sale.

Purchasers are solely responsible for the choice, selection and use of the ST products and services described herein, and ST assumes no liability whatsoever relating to the choice, selection or use of the ST products and services described herein.

No license, express or implied, by estoppel or otherwise, to any intellectual property rights is granted under this document. If any part of this document refers to any third party products or services it shall not be deemed a license grant by ST for the use of such third party products or services, or any intellectual property contained therein or considered as a warranty covering the use in any manner whatsoever of such third party products or services or any intellectual property contained therein.

UNLESS OTHERWISE SET FORTH IN ST'S TERMS AND CONDITIONS OF SALE ST DISCLAIMS ANY EXPRESS OR IMPLIED WARRANTY WITH RESPECT TO THE USE AND/OR SALE OF ST PRODUCTS INCLUDING WITHOUT LIMITATION IMPLIED WARRANTIES OF MERCHANTABILITY, FITNESS FOR A PARTICULAR PURPOSE (AND THEIR EQUIVALENTS UNDER THE LAWS OF ANY JURISDICTION), OR INFRINGEMENT OF ANY PATENT, COPYRIGHT OR OTHER INTELLECTUAL PROPERTY RIGHT.

UNLESS EXPRESSLY APPROVED IN WRITING BY AN AUTHORIZED REPRESENTATIVE OF ST, ST PRODUCTS ARE NOT DESIGNED, AUTHORIZED OR WARRANTED FOR USE IN MILITARY, AIR CRAFT, SPACE, LIFE SAVING, OR LIFE SUSTAINING APPLICATIONS, NOR IN PRODUCTS OR SYSTEMS, WHERE FAILURE OR MALFUNCTION MAY RESULT IN PERSONAL INJURY, DEATH, OR SEVERE PROPERTY OR ENVIRONMENTAL DAMAGE.

Resale of ST products with provisions different from the statements and/or technical features set forth in this document shall immediately void any warranty granted by ST for the ST product or service described herein and shall not create or extend in any manner whatsoever, any liability of ST.

ST and the ST logo are trademarks or registered trademarks of ST in various countries.

Information in this document supersedes and replaces all information previously supplied.

The ST logo is a registered trademark of STMicroelectronics. All other names are the property of their respective owners.

© 2006 STMicroelectronics - All rights reserved

STMicroelectronics group of companies

Australia - Belgium - Brazil - Canada - China - Czech Republic - Finland - France - Germany - Hong Kong - India - Israel - Italy - Japan - Malaysia - Malta - Morocco - Singapore - Spain - Sweden - Switzerland - United Kingdom - United States of America

www.st.com

Mouser Electronics

Authorized Distributor

Click to View Pricing, Inventory, Delivery & Lifecycle Information:

[STMicroelectronics:](#)

[STB40NF10LT4](#)