

Automotive-grade N-channel 30 V, 25 mΩ typ., 10 A STripFET™ H6 Power MOSFET in a DPAK package

Datasheet - production data

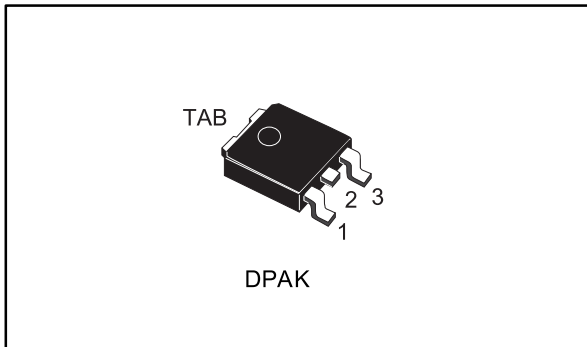
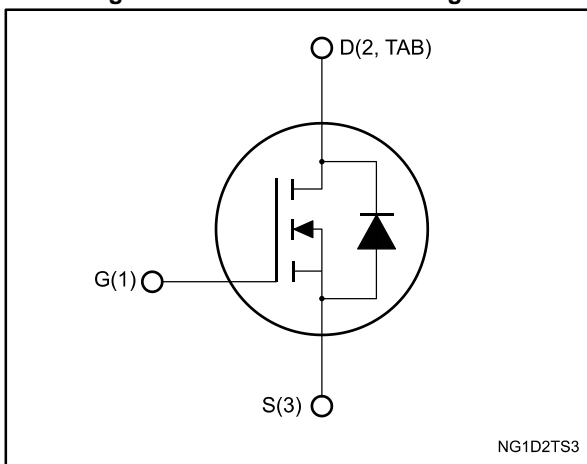

Figure 1: Internal schematic diagram



Features

Order code	V _{DS}	R _{DS(on)} max.	I _D	P _{TOT}
STD19N3LLH6AG	30 V	33 mΩ	10 A	30 W

- Designed for automotive applications and AEC-Q101 qualified
- Very low on-resistance
- Very low gate charge
- High avalanche ruggedness
- Low gate drive power loss
- Logic level

Applications

- Switching applications

Description

This device is an N-channel Power MOSFET developed using the STripFET™ H6 technology with a new trench gate structure. The resulting Power MOSFET exhibits very low R_{DS(on)} in all packages.

Table 1: Device summary

Order code	Marking	Package	Packing
STD19N3LLH6AG	19N3LLH6	DPAK	Tape and reel

Contents

1	Electrical ratings	3
2	Electrical characteristics	4
	2.1 Electrical characteristics (curves).....	6
3	Test circuits	8
4	Package information	9
	4.1 DPAK (TO-252) type A package information.....	9
	4.2 DPAK (TO-252) packing information.....	12
5	Revision history	14

1 Electrical ratings

Table 2: Absolute maximum ratings

Symbol	Parameter	Value	Unit
V_{DS}	Drain-source voltage	30	V
V_{GS}	Gate-source voltage	± 20	V
I_D	Drain current (continuous) at $T_{case} = 25\text{ °C}$ ⁽¹⁾	10	A
	Drain current (continuous) at $T_{case} = 100\text{ °C}$	10	
I_{DM} ⁽²⁾	Drain current (pulsed)	40	A
P_{TOT}	Total dissipation at $T_{case} = 25\text{ °C}$	30	W
T_{stg}	Storage temperature	-55 to 175	°C
T_j	Operating junction temperature		

Notes:

⁽¹⁾ Current limited by package. At $T_{case} = 25\text{ °C}$ the silicon is able to sustain 22 A.

⁽²⁾ Pulse width limited by safe operating area.

Table 3: Thermal data

Symbol	Parameter	Value	Unit
$R_{thj-case}$	Thermal resistance junction-case	5	°C/W
$R_{thj-pcb}$ ⁽¹⁾	Thermal resistance junction-pcb	50	

Notes:

⁽¹⁾When mounted on a 1-inch² FR-4, 2 Oz copper board.

Table 4: Avalanche characteristics

Symbol	Parameter	Value	Unit
I_{AV} ⁽¹⁾	Avalanche current, repetitive or not repetitive	10	A
E_{AS} ⁽²⁾	Single pulse avalanche energy	130	mJ

Notes:

⁽¹⁾ Pulse width limited by T_{jmax} .

⁽²⁾ starting $T_j = 25\text{ °C}$, $I_D = I_{AV}$, $V_{DD} = 25\text{ V}$.

2 Electrical characteristics

($T_{\text{case}} = 25\text{ °C}$ unless otherwise specified)

Table 5: Static

Symbol	Parameter	Test conditions	Min.	Typ.	Max.	Unit
$V_{(\text{BR})\text{DSS}}$	Drain-source breakdown voltage	$V_{\text{GS}} = 0\text{ V}$, $I_{\text{D}} = 250\text{ }\mu\text{A}$	30			V
I_{DSS}	Zero gate voltage drain current	$V_{\text{GS}} = 0\text{ V}$, $V_{\text{DS}} = 30\text{ V}$			1	μA
		$V_{\text{GS}} = 0\text{ V}$, $V_{\text{DS}} = 30\text{ V}$, $T_{\text{case}} = 125\text{ °C}$			100	μA
I_{GSS}	Gate-body leakage current	$V_{\text{DS}} = 0\text{ V}$, $V_{\text{GS}} = \pm 20\text{ V}$			± 100	nA
$V_{\text{GS}(\text{th})}$	Gate threshold voltage	$V_{\text{DS}} = V_{\text{GS}}$, $I_{\text{D}} = 250\text{ }\mu\text{A}$	1		2.5	V
$R_{\text{DS}(\text{on})}$	Static drain-source on-resistance	$V_{\text{GS}} = 10\text{ V}$, $I_{\text{D}} = 5\text{ A}$		25	33	m Ω
		$V_{\text{GS}} = 4.5\text{ V}$, $I_{\text{D}} = 5\text{ A}$		33	50	

Table 6: Dynamic

Symbol	Parameter	Test conditions	Min.	Typ.	Max.	Unit
C_{iss}	Input capacitance	$V_{\text{DS}} = 25\text{ V}$, $f = 1\text{ MHz}$, $V_{\text{GS}} = 0\text{ V}$	-	321	-	pF
C_{oss}	Output capacitance		-	68	-	
C_{riss}	Reverse transfer capacitance		-	34	-	
Q_{g}	Total gate charge	$V_{\text{DD}} = 15\text{ V}$, $I_{\text{D}} = 10\text{ A}$, $V_{\text{GS}} = 4.5\text{ V}$ (see Figure 14: "Test circuit for gate charge behavior")	-	3.7	-	nC
Q_{gs}	Gate-source charge		-	1	-	
Q_{gd}	Gate-drain charge		-	1.7	-	

Table 7: Switching times

Symbol	Parameter	Test conditions	Min.	Typ.	Max.	Unit
$t_{\text{d}(\text{on})}$	Turn-on delay time	$V_{\text{DD}} = 15\text{ V}$, $I_{\text{D}} = 5\text{ A}$ $R_{\text{G}} = 4.7\text{ }\Omega$, $V_{\text{GS}} = 10\text{ V}$ (see Figure 13: "Test circuit for resistive load switching times" and Figure 18: "Switching time waveform")	-	2.4	-	ns
t_{r}	Rise time		-	2.5	-	
$t_{\text{d}(\text{off})}$	Turn-off delay time		-	12.8	-	
t_{f}	Fall time		-	2.5	-	

Table 8: Source-drain diode

Symbol	Parameter	Test conditions	Min.	Typ.	Max.	Unit
I_{SD}	Source-drain current		-		10	A
$I_{SDM}^{(1)}$	Source-drain current (pulsed)		-		40	A
$V_{SD}^{(2)}$	Forward on voltage	$V_{GS} = 0\text{ V}$, $I_{SD} = 10\text{ A}$	-		1.12	V
t_{rr}	Reverse recovery time	$I_{SD} = 10\text{ A}$, $di/dt = 100\text{ A}/\mu\text{s}$, $V_{DD} = 24\text{ V}$ (see Figure 15 : "Test circuit for inductive load switching and diode recovery times")	-	15.1		ns
Q_{rr}	Reverse recovery charge		-	7.5		nC
I_{RRM}	Reverse recovery current		-	1		A

Notes:

(1) Pulse width is limited by safe operating area.

(2) Pulse test: pulse duration = 300 μs , duty cycle 1.5%.

2.1 Electrical characteristics (curves)

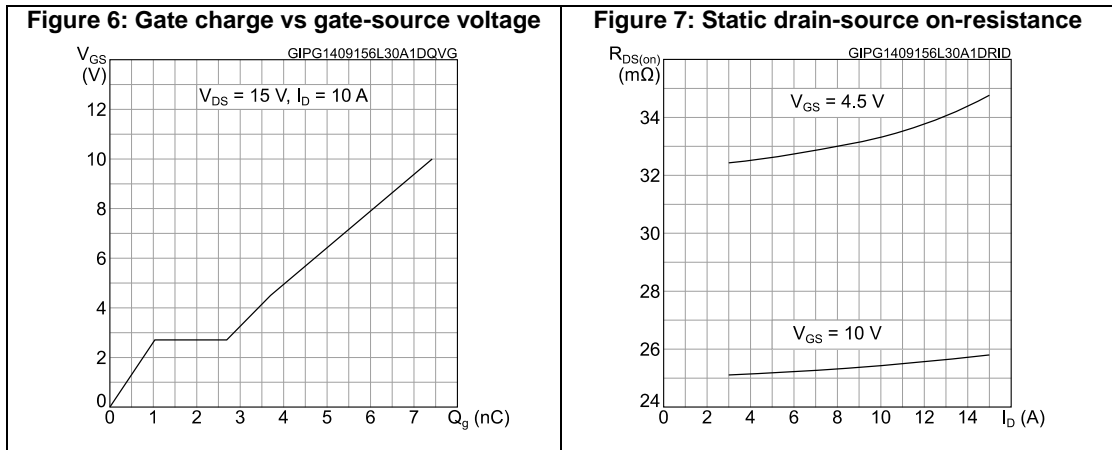
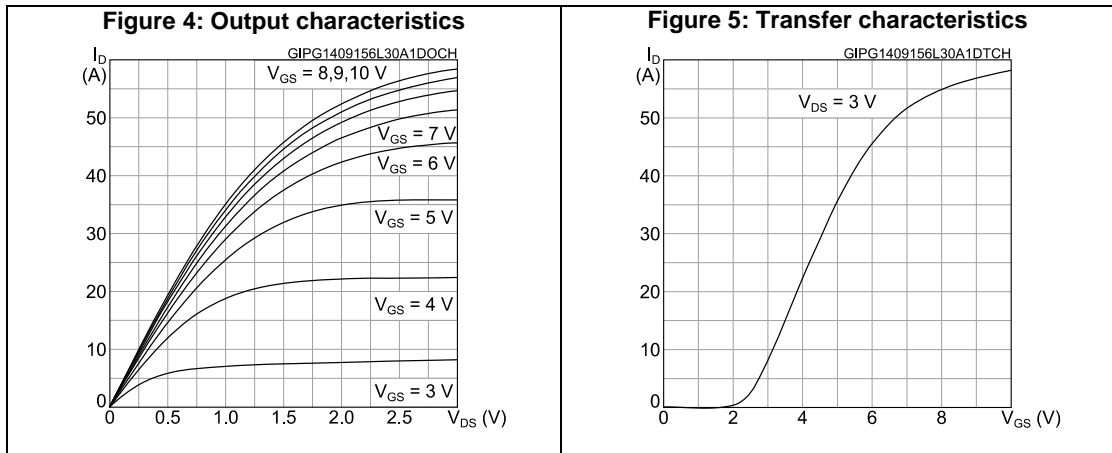
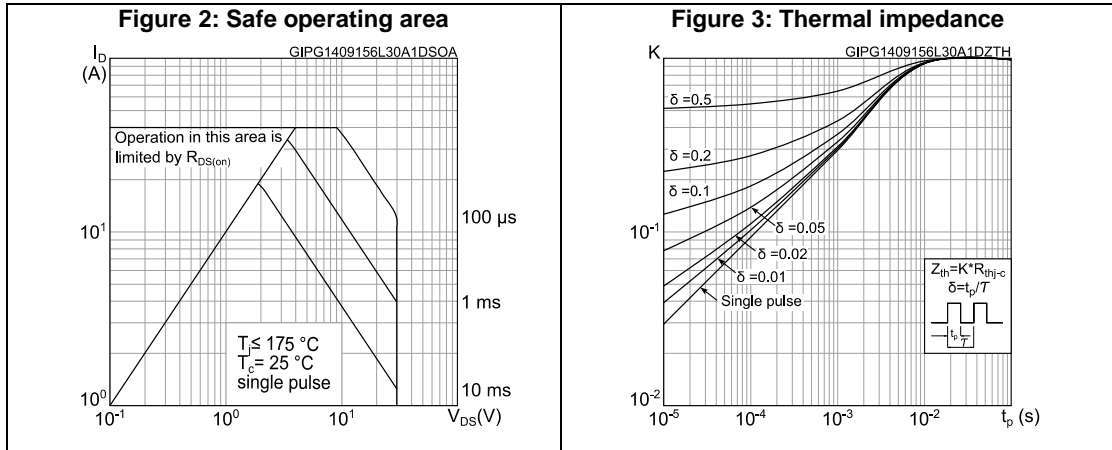

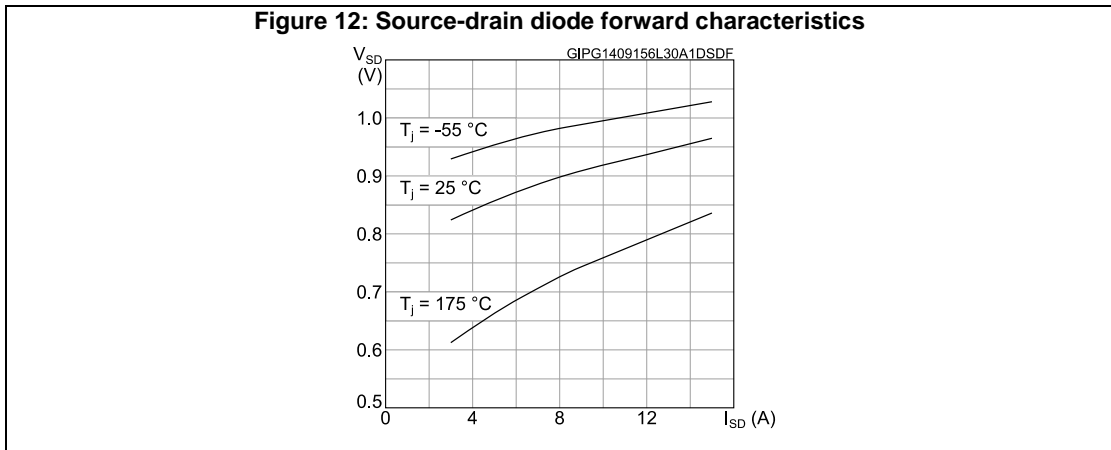
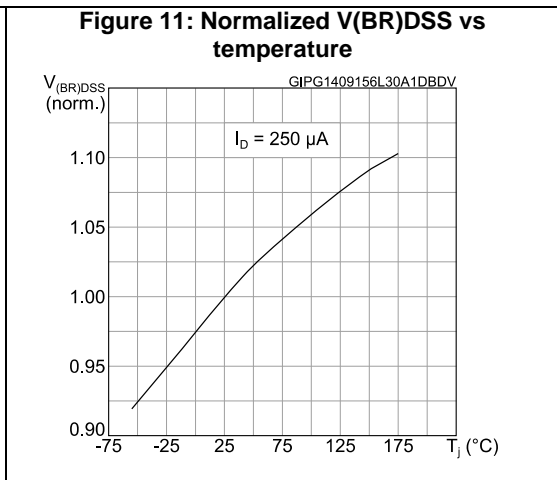
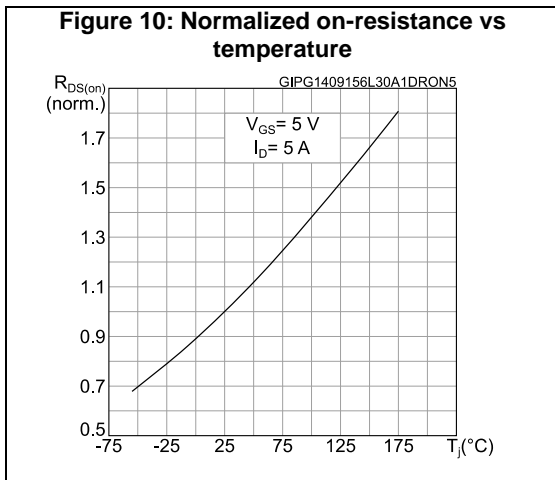
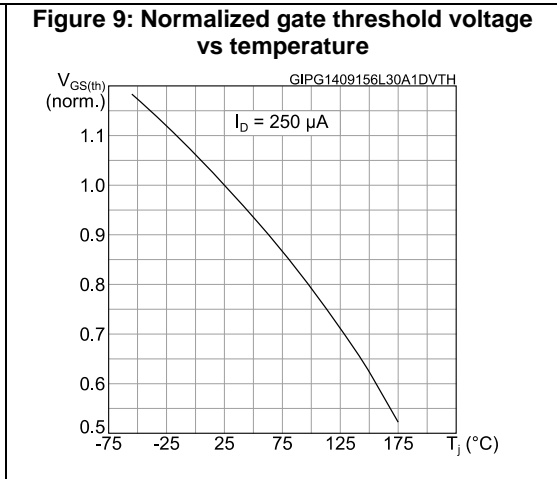
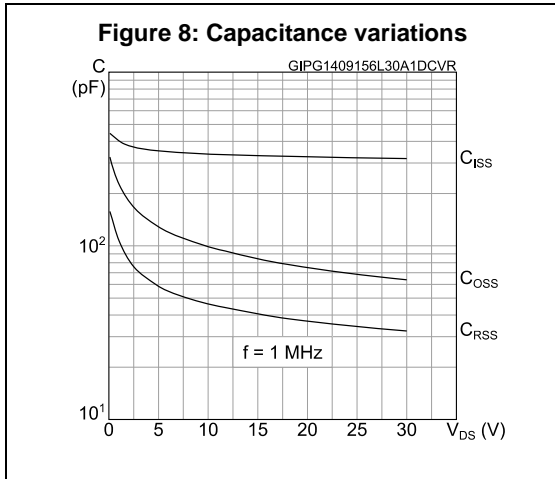

3 Test circuits

Figure 13: Test circuit for resistive load switching times



AM01468v1

Figure 14: Test circuit for gate charge behavior



AM01469v1

Figure 15: Test circuit for inductive load switching and diode recovery times



AM01470v1

Figure 16: Unclamped inductive load test circuit

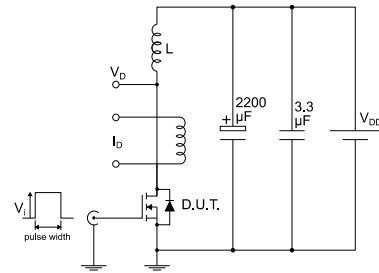

AM01471v1

Figure 17: Unclamped inductive waveform



AM01472v1

Figure 18: Switching time waveform

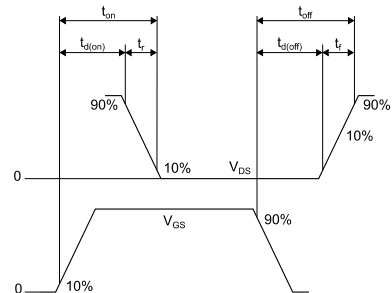

AM01473v1

4 Package information

In order to meet environmental requirements, ST offers these devices in different grades of ECOPACK® packages, depending on their level of environmental compliance. ECOPACK® specifications, grade definitions and product status are available at: www.st.com. ECOPACK® is an ST trademark.

4.1 DPAK (TO-252) type A package information

Figure 19: DPAK (TO-252) type A package outline

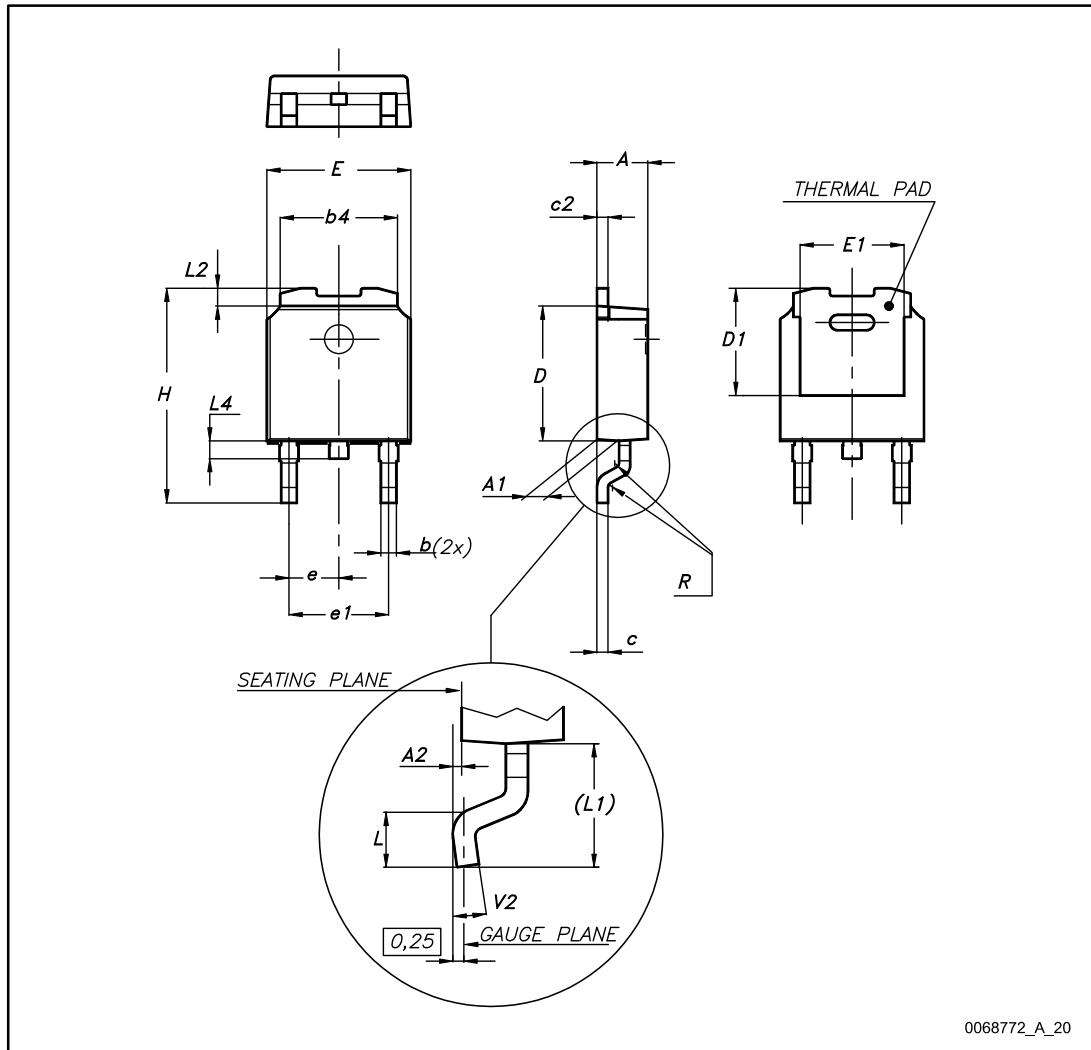
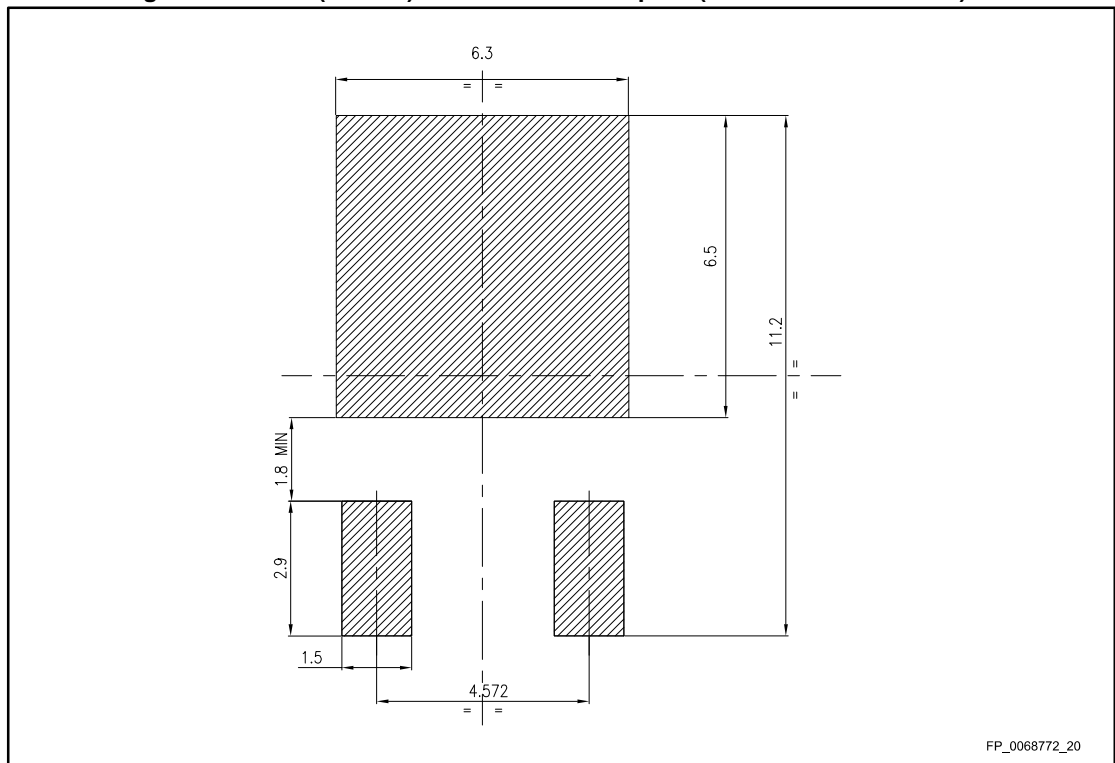

Table 9: DPAK (TO-252) type A mechanical data

Dim.	mm		
	Min.	Typ.	Max.
A	2.20		2.40
A1	0.90		1.10
A2	0.03		0.23
b	0.64		0.90
b4	5.20		5.40
c	0.45		0.60
c2	0.48		0.60
D	6.00		6.20
D1	4.95	5.10	5.25
E	6.40		6.60
E1	4.60	4.70	4.80
e	2.16	2.28	2.40
e1	4.40		4.60
H	9.35		10.10
L	1.00		1.50
(L1)	2.60	2.80	3.00
L2	0.65	0.80	0.95
L4	0.60		1.00
R		0.20	
V2	0°		8°

Figure 20: DPAK (TO-252) recommended footprint (dimensions are in mm)



4.2 DPAK (TO-252) packing information

Figure 21: DPAK (TO-252) tape outline

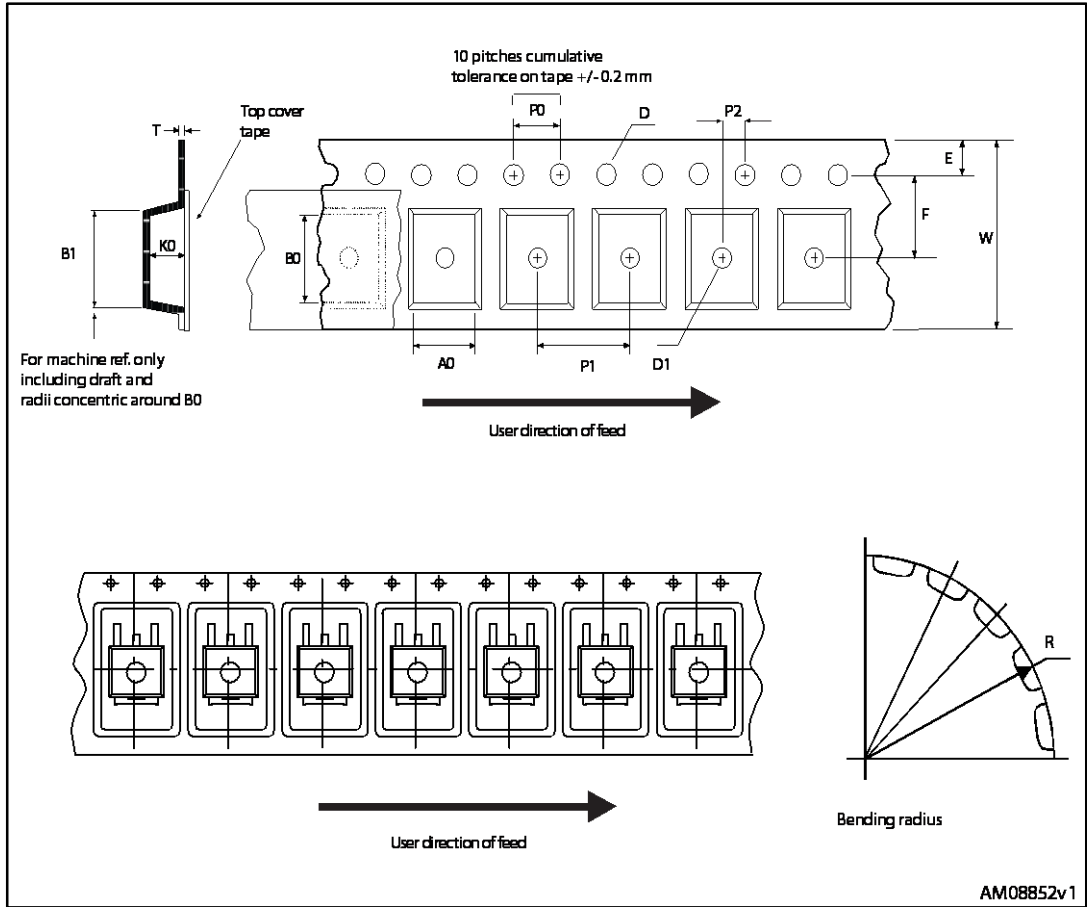

Figure 22: DPAK (TO-252) reel outline

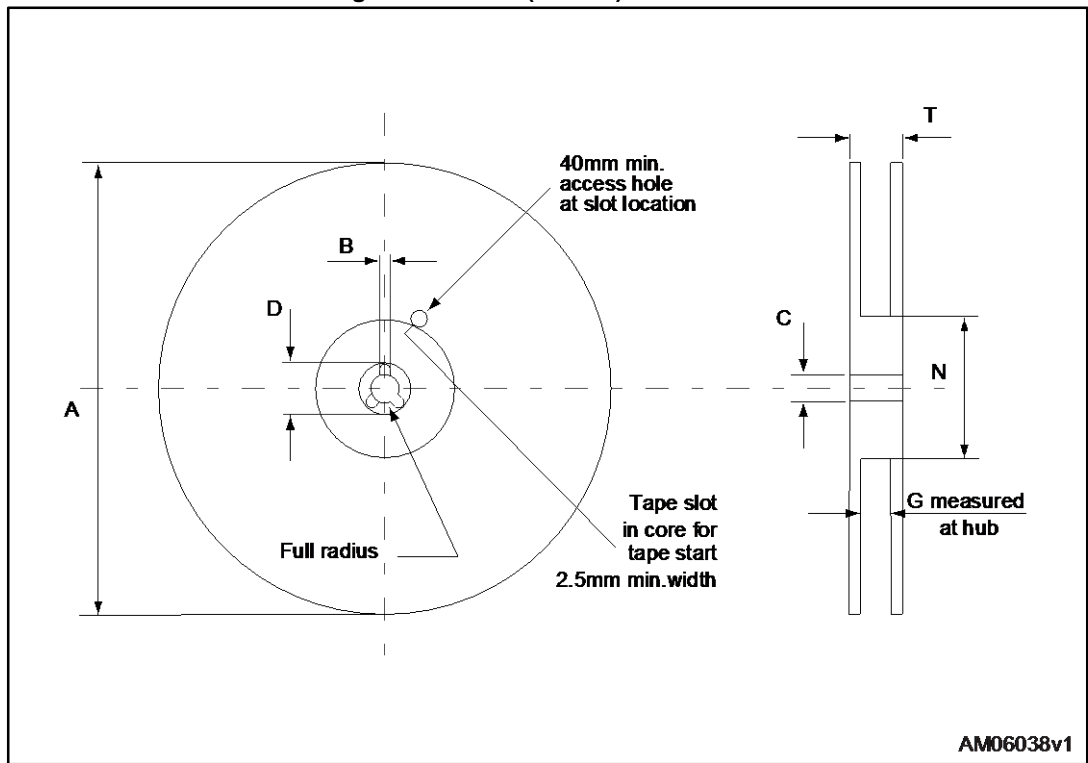

Table 10: DPAK (TO-252) tape and reel mechanical data

Tape			Reel		
Dim.	mm		Dim.	mm	
	Min.	Max.		Min.	Max.
A0	6.8	7	A		330
B0	10.4	10.6	B	1.5	
B1		12.1	C	12.8	13.2
D	1.5	1.6	D	20.2	
D1	1.5		G	16.4	18.4
E	1.65	1.85	N	50	
F	7.4	7.6	T		22.4
K0	2.55	2.75			
P0	3.9	4.1	Base qty.		2500
P1	7.9	8.1	Bulk qty.		2500
P2	1.9	2.1			
R	40				
T	0.25	0.35			
W	15.7	16.3			

5 Revision history

Table 11: Document revision history

Date	Revision	Changes
01-Oct-2015	1	Initial version
13-Oct-2015	2	On cover page: - updated title In section Electrical characteristics: - updated table Dynamic Updated section Test circuits

IMPORTANT NOTICE – PLEASE READ CAREFULLY

STMicroelectronics NV and its subsidiaries ("ST") reserve the right to make changes, corrections, enhancements, modifications, and improvements to ST products and/or to this document at any time without notice. Purchasers should obtain the latest relevant information on ST products before placing orders. ST products are sold pursuant to ST's terms and conditions of sale in place at the time of order acknowledgement.

Purchasers are solely responsible for the choice, selection, and use of ST products and ST assumes no liability for application assistance or the design of Purchasers' products.

No license, express or implied, to any intellectual property right is granted by ST herein.

Resale of ST products with provisions different from the information set forth herein shall void any warranty granted by ST for such product.

ST and the ST logo are trademarks of ST. All other product or service names are the property of their respective owners.

Information in this document supersedes and replaces information previously supplied in any prior versions of this document.

© 2015 STMicroelectronics – All rights reserved

Mouser Electronics

Authorized Distributor

Click to View Pricing, Inventory, Delivery & Lifecycle Information:

[STMicroelectronics:](#)

[STD19N3LLH6AG](#)