



STD65N3LLH5 STU65N3LLH5

N-channel 30 V, 0.0061 Ω , 65 A, DPAK, IPAK
STripFET™ V Power MOSFET

Features

Type	V _{DSS}	R _{DS(on)} max	I _D
STD65N3LLH5	30 V	0.0069 Ω	65 A
STU65N3LLH5	30 V	0.0073 Ω	65 A

- R_{DS(on)} * Q_g industry benchmark
- Extremely low on-resistance R_{DS(on)}
- Very low switching gate charge
- High avalanche ruggedness
- Low gate drive power losses

Application

Switching applications

Description

This STripFET™V Power MOSFET technology is among the latest improvements, which have been especially tailored to achieve very low on-state resistance providing also one of the best-in-class figure of merit.

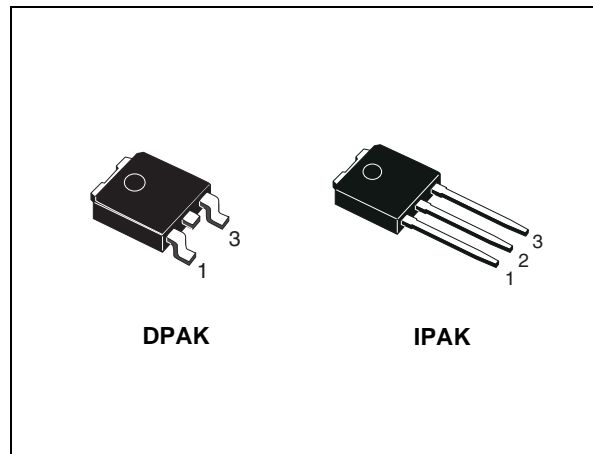

Figure 1. Internal schematic diagram

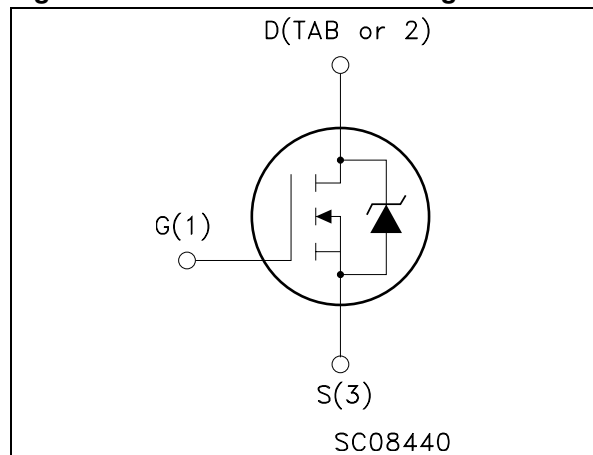

Table 1. Device summary

Order code	Marking	Package	Packaging
STD65N3LLH5	65N3LLH5	DPAK	Tape and reel
STU65N3LLH5	65N3LLH5	IPAK	Tube

Contents

1	Electrical ratings	3
2	Electrical characteristics	4
2.1	Electrical characteristics (curves)	6
3	Test circuits	8
4	Package mechanical data	9
5	Packaging mechanical data	14
6	Revision history	16

1 Electrical ratings

Table 2. Absolute maximum ratings

Symbol	Parameter	Value	Unit
V_{DS}	Drain-source voltage ($V_{GS}=0$)	30	V
V_{GS}	Gate-source voltage	± 22	V
I_D	Drain current (continuous) at $T_C = 25\text{ }^\circ\text{C}$	65	A
I_D	Drain current (continuous) at $T_C = 100\text{ }^\circ\text{C}$	46	A
$I_{DM}^{(1)}$	Drain current (pulsed)	260	A
P_{TOT}	Total dissipation at $T_C = 25\text{ }^\circ\text{C}$	50	W
	Derating factor	0.3	W/ $^\circ\text{C}$
$E_{AS}^{(2)}$	Single pulse avalanche energy	TBD	mJ
T_j T_{stg}	Operating junction temperature Storage temperature	-55 to 175	$^\circ\text{C}$

1. Pulse width limited by safe operating area.

2. Starting $T_j = 25\text{ }^\circ\text{C}$, $I_d = 32.5\text{ A}$, $V_{dd} = 12\text{ V}$.

Table 3. Thermal resistance

Symbol	Parameter	Value	Unit
$R_{thj-case}$	Thermal resistance junction-case max	3	$^\circ\text{C/W}$
$R_{thj-amb}$	Thermal resistance junction-case max	100	$^\circ\text{C/W}$
T_j	Maximum lead temperature for soldering purpose	275	$^\circ\text{C}$

2 Electrical characteristics

($T_{CASE} = 25\text{ °C}$ unless otherwise specified).

Table 4. Static

Symbol	Parameter	Test conditions	Min.	Typ.	Max.	Unit
$V_{(BR)DSS}$	Drain-source breakdown Voltage	$I_D = 250\ \mu\text{A}$, $V_{GS} = 0$	30			V
I_{DSS}	Zero gate voltage drain current ($V_{GS} = 0$)	$V_{DS} = 30\text{ V}$ $V_{DS} = 30\text{ V}$, $T_c = 125\text{ °C}$			1 10	μA μA
I_{GSS}	Gate body leakage current ($V_{DS} = 0$)	$V_{GS} = \pm 22\text{ V}$			± 100	nA
$V_{GS(th)}$	Gate threshold voltage	$V_{DS} = V_{GS}$, $I_D = 250\ \mu\text{A}$	1	1.8	3	V
$R_{DS(on)}$	Static drain-source on resistance	$V_{GS} = 10\text{ V}$, $I_D = 32.5\text{ A}$ SMD version		0.0061	0.0069	Ω
		$V_{GS} = 10\text{ V}$, $I_D = 32.5\text{ A}$		0.0065	0.0073	Ω
		$V_{GS} = 4.5\text{ V}$, $I_D = 32.5\text{ A}$ SMD version		0.0084	0.0093	Ω
		$V_{GS} = 4.5\text{ V}$, $I_D = 32.5\text{ A}$		0.0088	0.0097	Ω

Table 5. Dynamic

Symbol	Parameter	Test conditions	Min.	Typ.	Max.	Unit
C_{iss}	Input capacitance	$V_{DS} = 25\text{ V}$, $f = 1\text{ MHz}$, $V_{GS} = 0$		1290		pF
C_{oss}	Output capacitance		-	240	-	pF
C_{rss}	Reverse transfer capacitance				32	pF
Q_g	Total gate charge	$V_{DD} = 15\text{ V}$, $I_D = 65\text{ A}$		8		nC
Q_{gs}	Gate-source charge	$V_{GS} = 4.5\text{ V}$		3.6		nC
Q_{gd}	Gate-drain charge	(<i>Figure 14</i>)		3.4		nC
R_g	Intrinsic gate resistance	$f = 1\text{ MHz}$ Gate DC Bias = 0 test signal level = 20 mV open drain		1.7		Ω

Table 6. Switching on/off (resistive load)

Symbol	Parameter	Test conditions	Min.	Typ.	Max.	Unit
$t_{d(on)}$ t_r	Turn-on delay time Rise time	$V_{DD}=10\text{ V}$, $I_D=65\text{ A}$, $R_G=4.7\ \Omega$, $V_{GS}=10\text{ V}$ (<i>Figure 13</i> and <i>Figure 18</i>)	-	8.6 11.2	-	ns ns
$t_{d(off)}$ t_f	Turn-off delay time Fall time	$V_{DD}=10\text{ V}$, $I_D=25\text{ A}$, $R_G=4.7\ \Omega$, $V_{GS}=10\text{ V}$ (<i>Figure 13</i> and <i>Figure 18</i>)	-	32.4 6	-	ns ns

Table 7. Source drain diode

Symbol	Parameter	Test conditions	Min.	Typ.	Max.	Unit
I_{SD} I_{SDM}	Source-drain current Source-drain current (pulsed) ⁽¹⁾		-		65 260	A A
V_{SD}	Forward on voltage	$I_{SD}=32.5\text{ A}$, $V_{GS}=0$	-		1.1	V
t_{rr} Q_{rr} I_{RRM}	Reverse recovery time Reverse recovery charge Reverse recovery current	$I_{SD}=32.5\text{ A}$, $di/dt=100\text{ A}/\mu\text{s}$, $V_{DD}=20\text{ V}$, (<i>Figure 15</i>)	-	22 15 1.4		ns nC A

1. Pulsed: pulse duration = 300 μs , duty cycle 1.5%.

2.1 Electrical characteristics (curves)

Figure 2. Safe operating area

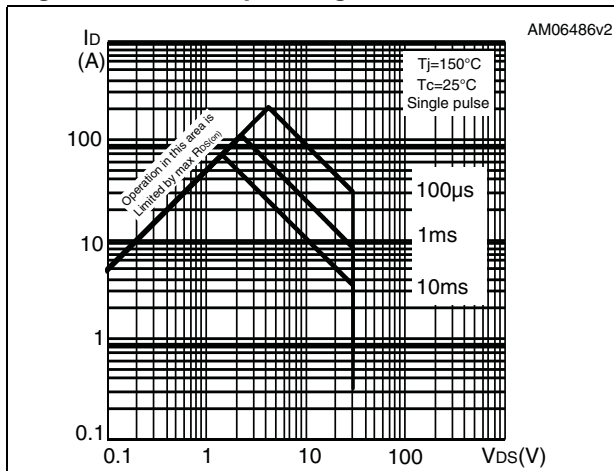

Figure 3. Thermal impedance

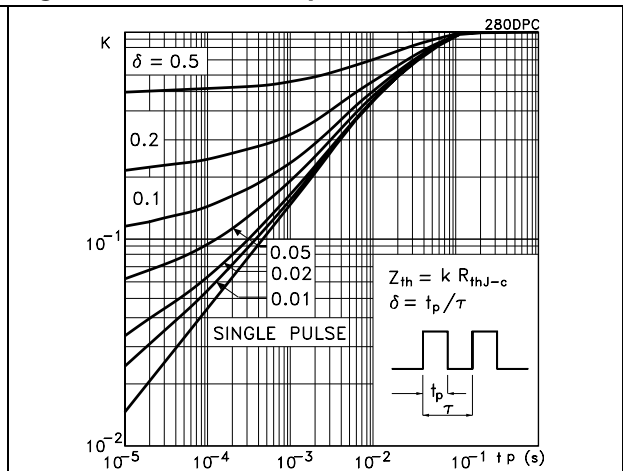

Figure 4. Output characteristics

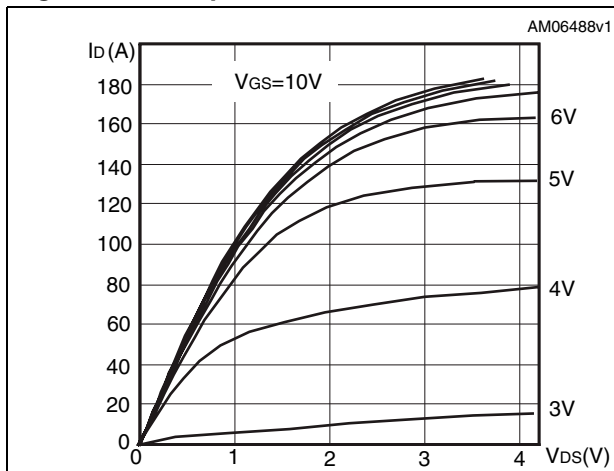

Figure 5. Transfer characteristics

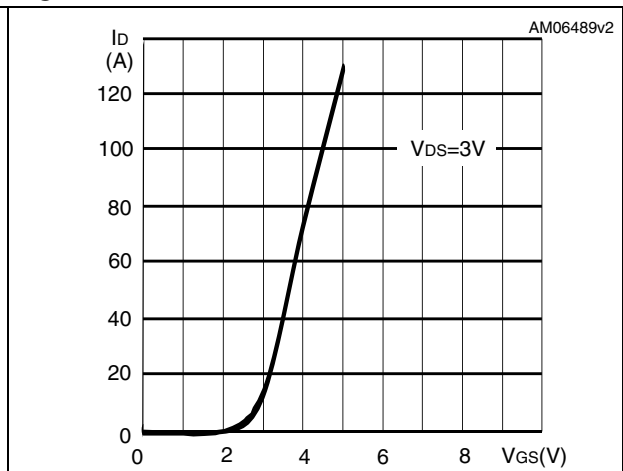

Figure 6. Normalized BV_{DSS} vs temperature

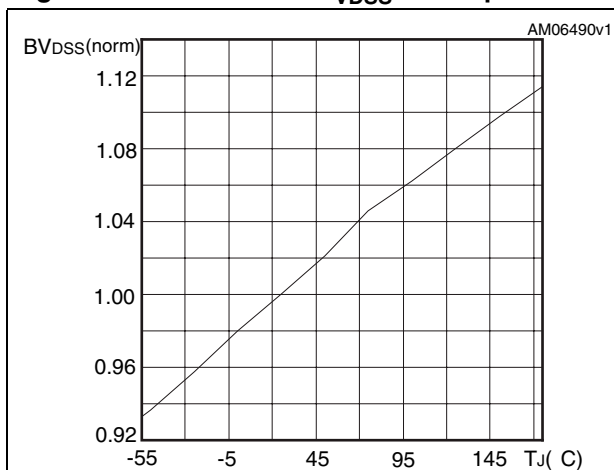

Figure 7. Static drain-source on resistance

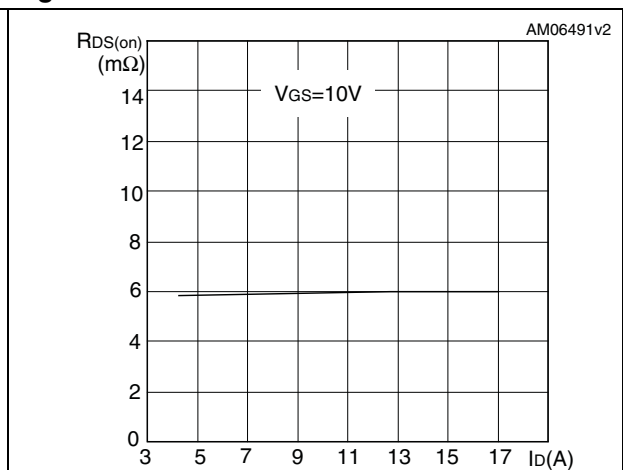

Figure 8. Gate charge vs gate-source voltage Figure 9. Capacitance variations

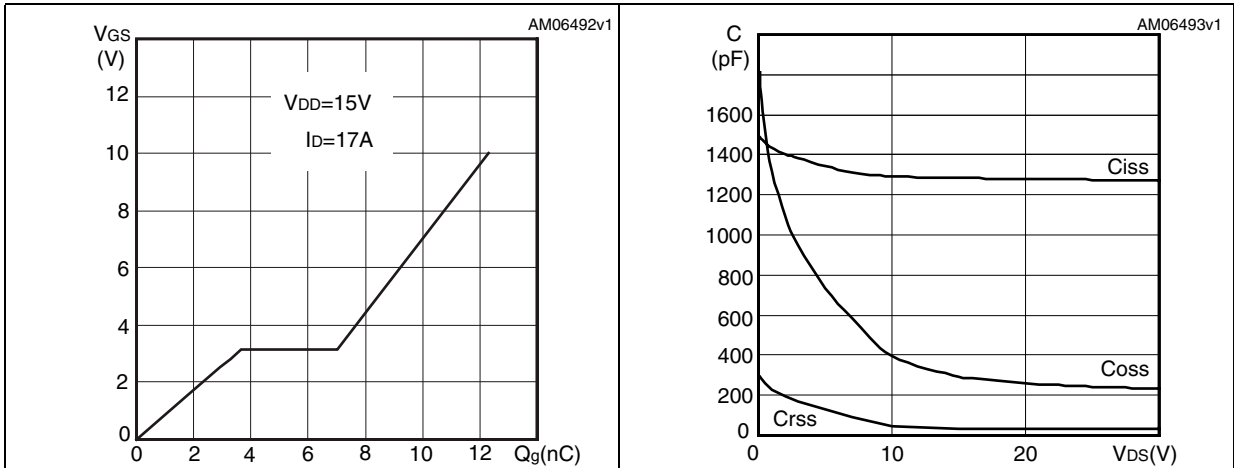

Figure 10. Normalized gate threshold voltage vs temperature Figure 11. Normalized on resistance vs temperature

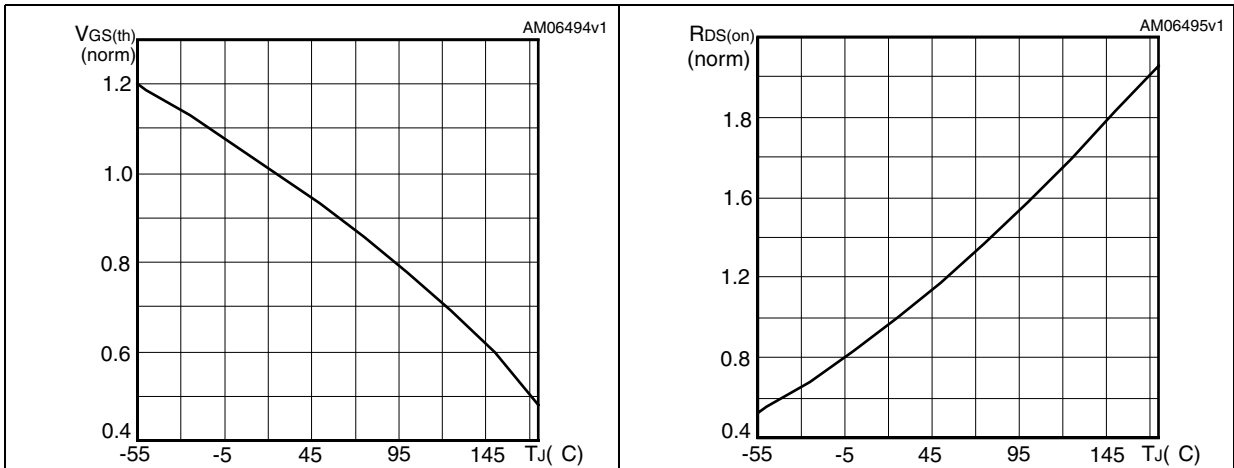
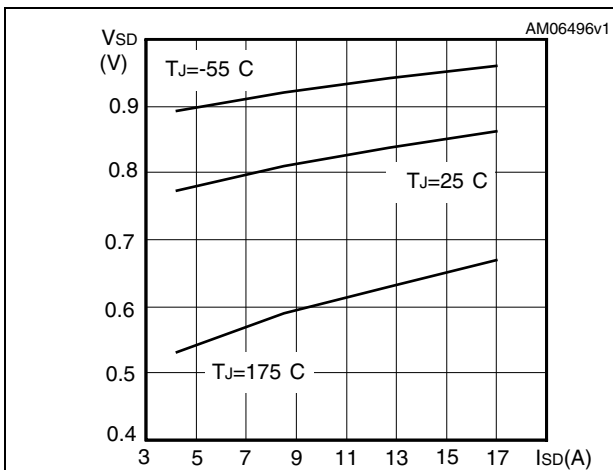

Figure 12. Source-drain diode forward characteristics



4 Package mechanical data

In order to meet environmental requirements, ST offers these devices in different grades of ECOPACK® packages, depending on their level of environmental compliance. ECOPACK® specifications, grade definitions and product status are available at: www.st.com. ECOPACK is an ST trademark.

Table 8. DPAK (TO-252) mechanical data

Dim.	mm		
	Min.	Typ.	Max.
A	2.20		2.40
A1	0.90		1.10
A2	0.03		0.23
b	0.64		0.90
b4	5.20		5.40
c	0.45		0.60
c2	0.48		0.60
D	6.00		6.20
D1		5.10	
E	6.40		6.60
E1		4.70	
e		2.28	
e1	4.40		4.60
H	9.35		10.10
L	1		
L1		2.80	
L2		0.80	
L4	0.60		1
R		0.20	
V2	0°		8°

Figure 19. DPAK footprint^(a)

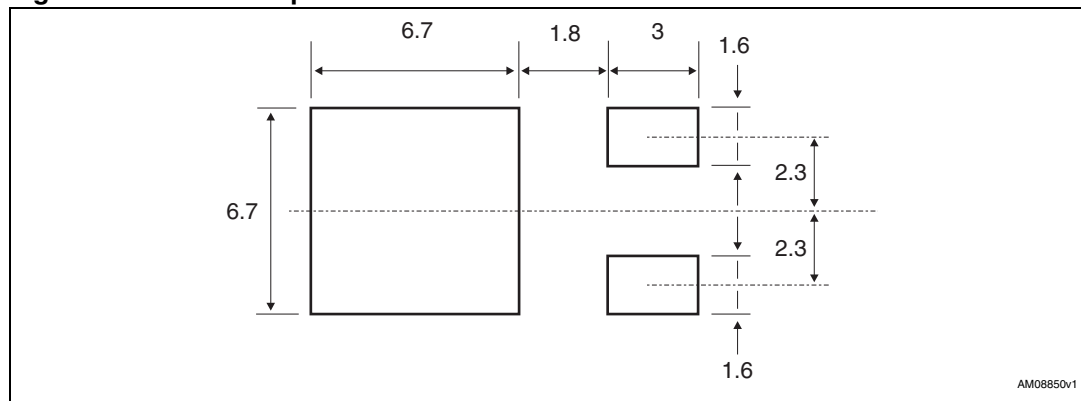

a. All dimension are in millimeters

Figure 20. DPAK (TO-252) drawing

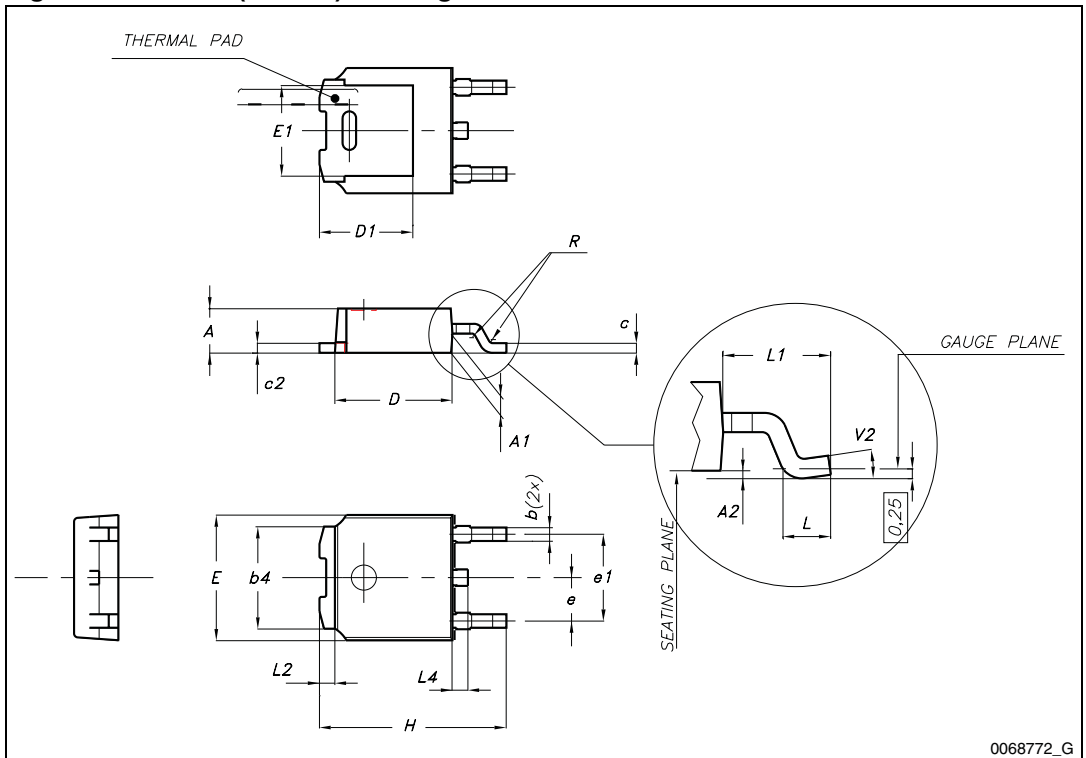
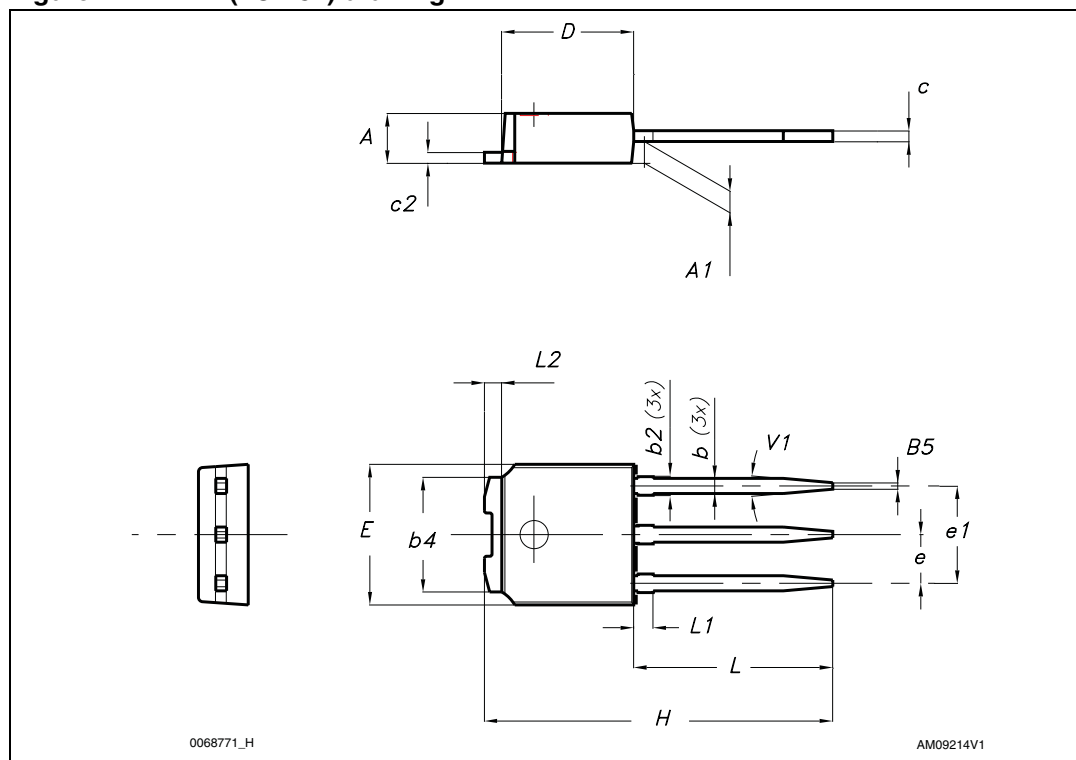

Table 9. IPAK (TO-251) mechanical data

Dim.	mm.		
	Min.	Typ.	Max.
A	2.20		2.40
A1	0.90		1.10
b	0.64		0.90
b2			0.95
b4	5.20		5.40
B5		0.3	
c	0.45		0.60
c2	0.48		0.60
D	6.00		6.20
E	6.40		6.60
e		2.28	
e1	4.40		4.60
H		16.10	
L	9.00		9.40
L1	0.80		1.20
L2		0.80	1.00
V1		10°	

Figure 21. IPAK (TO-251) drawing



5 Packaging mechanical data

Table 10. DPAK (TO-252) tape and reel mechanical data

Tape			Reel		
Dim.	mm		Dim.	mm	
	Min.	Max.		Min.	Max.
A0	6.8	7	A		330
B0	10.4	10.6	B	1.5	
B1		12.1	C	12.8	13.2
D	1.5	1.6	D	20.2	
D1	1.5		G	16.4	18.4
E	1.65	1.85	N	50	
F	7.4	7.6	T		22.4
K0	2.55	2.75			
P0	3.9	4.1	Base qty.		2500
P1	7.9	8.1	Bulk qty.		2500
P2	1.9	2.1			
R	40				
T	0.25	0.35			
W	15.7	16.3			

Figure 22. Tape for DPAK (TO-252)

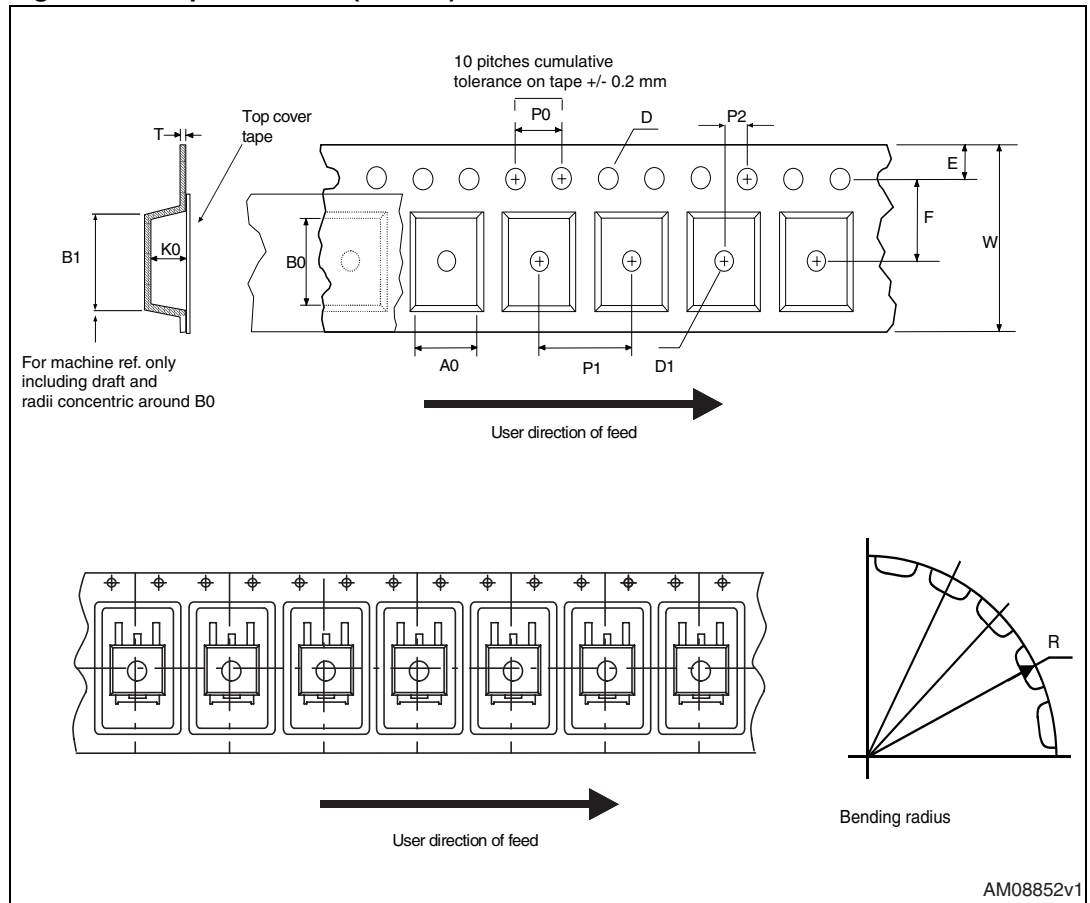
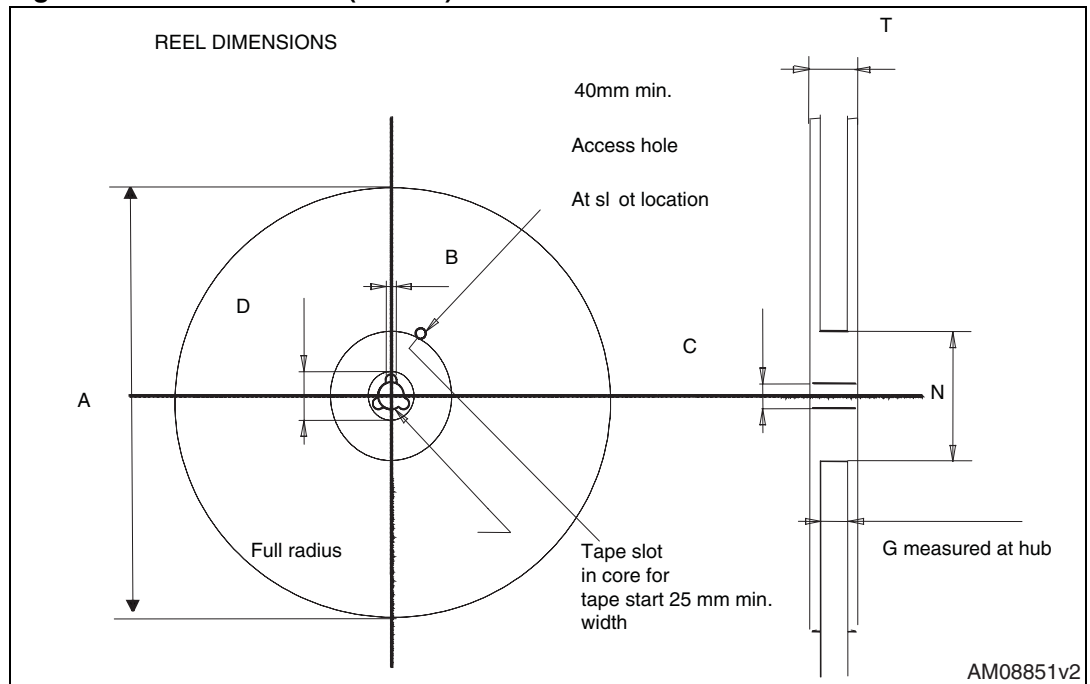

Figure 23. Reel for DPAK (TO-252)



6 Revision history

Table 11. Document revision history

Date	Revision	Changes
19-May-2011	1	First release.

Please Read Carefully:

Information in this document is provided solely in connection with ST products. STMicroelectronics NV and its subsidiaries ("ST") reserve the right to make changes, corrections, modifications or improvements, to this document, and the products and services described herein at any time, without notice.

All ST products are sold pursuant to ST's terms and conditions of sale.

Purchasers are solely responsible for the choice, selection and use of the ST products and services described herein, and ST assumes no liability whatsoever relating to the choice, selection or use of the ST products and services described herein.

No license, express or implied, by estoppel or otherwise, to any intellectual property rights is granted under this document. If any part of this document refers to any third party products or services it shall not be deemed a license grant by ST for the use of such third party products or services, or any intellectual property contained therein or considered as a warranty covering the use in any manner whatsoever of such third party products or services or any intellectual property contained therein.

UNLESS OTHERWISE SET FORTH IN ST'S TERMS AND CONDITIONS OF SALE ST DISCLAIMS ANY EXPRESS OR IMPLIED WARRANTY WITH RESPECT TO THE USE AND/OR SALE OF ST PRODUCTS INCLUDING WITHOUT LIMITATION IMPLIED WARRANTIES OF MERCHANTABILITY, FITNESS FOR A PARTICULAR PURPOSE (AND THEIR EQUIVALENTS UNDER THE LAWS OF ANY JURISDICTION), OR INFRINGEMENT OF ANY PATENT, COPYRIGHT OR OTHER INTELLECTUAL PROPERTY RIGHT.

UNLESS EXPRESSLY APPROVED IN WRITING BY AN AUTHORIZED ST REPRESENTATIVE, ST PRODUCTS ARE NOT RECOMMENDED, AUTHORIZED OR WARRANTED FOR USE IN MILITARY, AIR CRAFT, SPACE, LIFE SAVING, OR LIFE SUSTAINING APPLICATIONS, NOR IN PRODUCTS OR SYSTEMS WHERE FAILURE OR MALFUNCTION MAY RESULT IN PERSONAL INJURY, DEATH, OR SEVERE PROPERTY OR ENVIRONMENTAL DAMAGE. ST PRODUCTS WHICH ARE NOT SPECIFIED AS "AUTOMOTIVE GRADE" MAY ONLY BE USED IN AUTOMOTIVE APPLICATIONS AT USER'S OWN RISK.

Resale of ST products with provisions different from the statements and/or technical features set forth in this document shall immediately void any warranty granted by ST for the ST product or service described herein and shall not create or extend in any manner whatsoever, any liability of ST.

ST and the ST logo are trademarks or registered trademarks of ST in various countries.

Information in this document supersedes and replaces all information previously supplied.

The ST logo is a registered trademark of STMicroelectronics. All other names are the property of their respective owners.

© 2011 STMicroelectronics - All rights reserved

STMicroelectronics group of companies

Australia - Belgium - Brazil - Canada - China - Czech Republic - Finland - France - Germany - Hong Kong - India - Israel - Italy - Japan - Malaysia - Malta - Morocco - Philippines - Singapore - Spain - Sweden - Switzerland - United Kingdom - United States of America

www.st.com



Mouser Electronics

Authorized Distributor

Click to View Pricing, Inventory, Delivery & Lifecycle Information:

[STMicroelectronics:](#)

[STU65N3LLH5](#)