



STPS20170C

HIGH VOLTAGE POWER SCHOTTKY RECTIFIER

Table 1: Main Product Characteristics

$I_{F(AV)}$	2 x 10 A
V_{RRM}	170 V
T_j	175°C
$V_F(max)$	0.75 V

Features

- High reverse voltage
- High junction temperature capability
- Avalanche specification with derating curves

Benefits

- Can challenge bipolar ultrafast diodes with better dynamic characteristics.

Description

Dual center tap Schottky rectifier diode suited for high frequency switched mode power supplies.

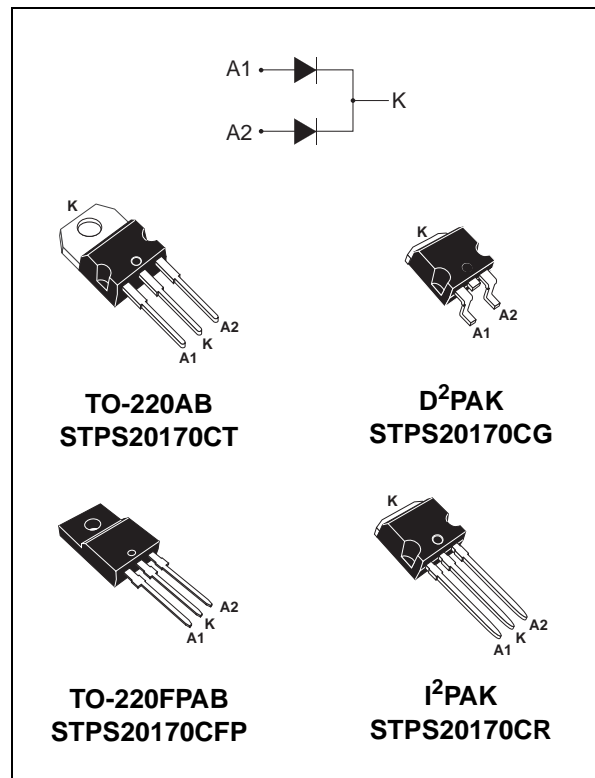

Table 2: Order Codes

Part Numbers	Marking
STPS20170CT	STPS20170CT
STPS20170CFP	STPS20170CFP
STPS20170CR	STPS20170CR
STPS20170CG	STPS20170CG
STPS20170CG-TR	STPS20170CG

STPS20170C

Table 3: Absolute Ratings (limiting values, per diode)

Symbol	Parameter				Value	Unit
V_{RRM}	Repetitive peak reverse voltage				170	V
$I_{F(RMS)}$	RMS forward current				30	A
$I_{F(AV)}$	Average forward current $\delta = 0.5$	TO-220AB / D ² PAK / I ² PAK	$T_c = 155^\circ\text{C}$	Per diode Per device	10 20	A
		TO-220FPAB	$T_c = 135^\circ\text{C}$	Per diode Per device	10 20	
I_{FSM}	Surge non repetitive forward current		$t_p = 10\text{ms}$ sinusoidal		180	A
P_{ARM}	Repetitive peak avalanche power		$t_p = 1\mu\text{s}$ $T_j = 25^\circ\text{C}$		6700	W
T_{stg}	Storage temperature range				-65 to + 175	$^\circ\text{C}$
T_j	Maximum operating junction temperature *				175	$^\circ\text{C}$
dV/dt	Critical rate of rise of reverse voltage				10000	V/ μs

* : $\frac{dP_{tot}}{dT_j} < \frac{1}{R_{th(j-a)}}$ thermal runaway condition for a diode on its own heatsink

Table 4: Thermal Parameters

Symbol	Parameter			Value	Unit
$R_{th(j-c)}$	Junction to case	TO-220AB / D ² PAK / I ² PAK	Per diode Total	2.2 1.3	$^\circ\text{C/W}$
		TO-220FPAB	Per diode Total	4.5 3.5	
$R_{th(c)}$		TO-220AB / D ² PAK / I ² PAK	Coupling	0.3	
		TO-220FPAB		2.5	

When the diodes 1 and 2 are used simultaneously:

$$\Delta T_j(\text{diode } 1) = P(\text{diode } 1) \times R_{th(j-c)}(\text{Per diode}) + P(\text{diode } 2) \times R_{th(c)}$$

Table 5: Static Electrical Characteristics (per diode)

Symbol	Parameter	Tests conditions		Min.	Typ	Max.	Unit
I_R *	Reverse leakage current	$T_j = 25^\circ\text{C}$	$V_R = V_{RRM}$			15	μA
		$T_j = 125^\circ\text{C}$				15	mA
V_F **	Forward voltage drop	$T_j = 25^\circ\text{C}$	$I_F = 10\text{A}$			0.90	V
		$T_j = 125^\circ\text{C}$			0.69	0.75	
		$T_j = 25^\circ\text{C}$	$I_F = 20\text{A}$			0.99	
		$T_j = 125^\circ\text{C}$			0.79	0.86	

Pulse test: * $t_p = 5\text{ ms}$, $\delta < 2\%$

** $t_p = 380\ \mu\text{s}$, $\delta < 2\%$

To evaluate the conduction losses use the following equation: $P = 0.64 \times I_{F(AV)} + 0.011 I_{F(RMS)}^2$

Figure 1: Average forward power dissipation versus average forward current (per diode)

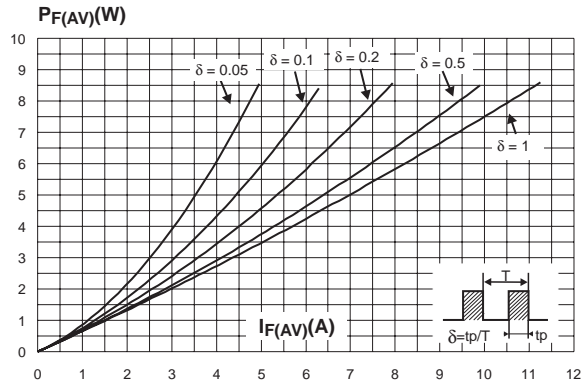

Figure 2: Average forward current versus ambient temperature ($\delta = 0.5$, per diode)

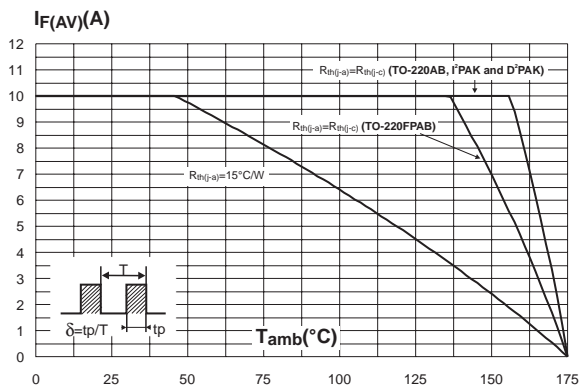

Figure 3: Normalized avalanche power derating versus pulse duration

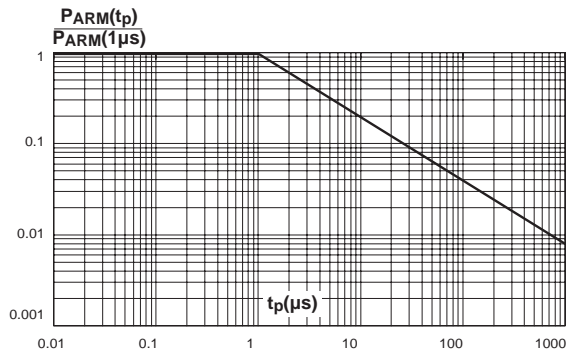

Figure 4: Normalized avalanche power derating versus junction temperature

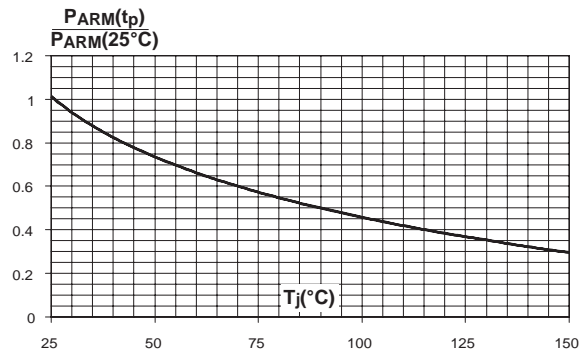

Figure 5: Non repetitive surge peak forward current versus overload duration (maximum values, per diode) (TO-220AB, D²PAK, I²PAK)

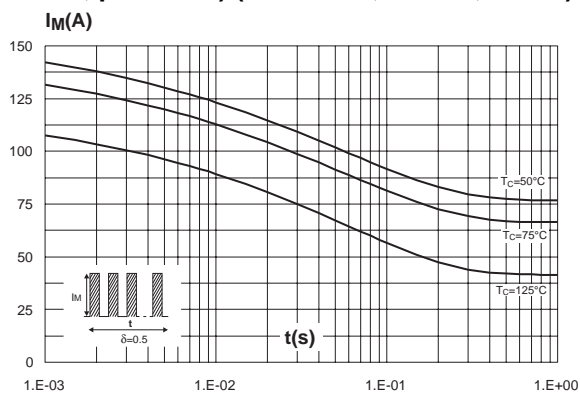

Figure 6: Non repetitive surge peak forward current versus overload duration (maximum values, per diode) (TO-220FPAB)

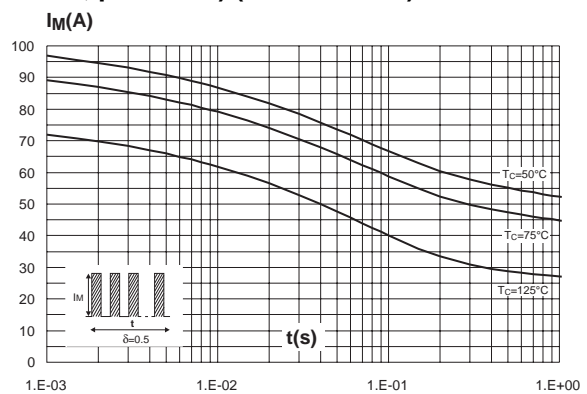

Figure 7: Relative variation of thermal impedance junction to case versus pulse duration

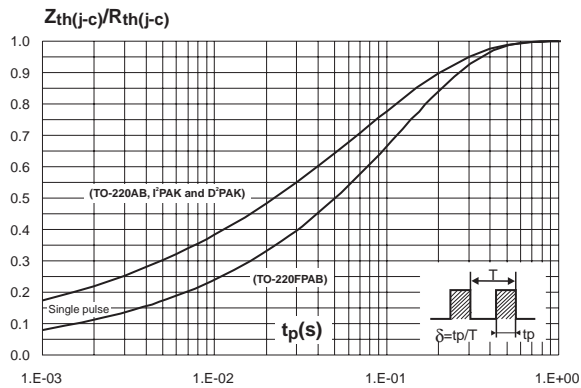

Figure 8: Reverse leakage current versus reverse voltage applied (typical values, per diode)

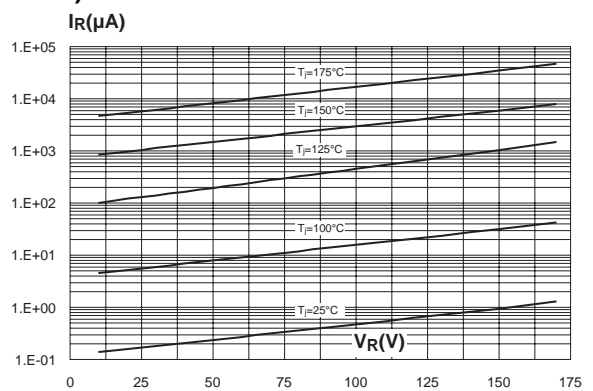

Figure 9: Junction capacitance versus reverse voltage applied (typical values, per diode)

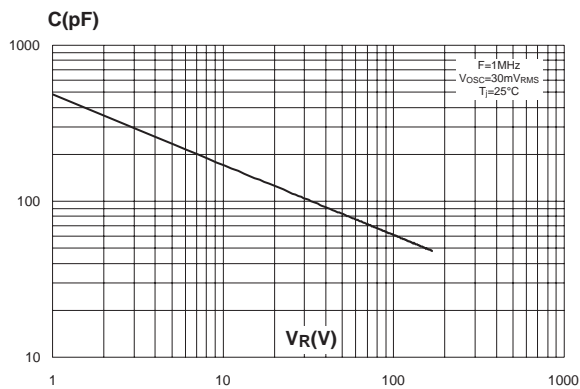

Figure 10: Forward voltage drop versus forward current (per diode)

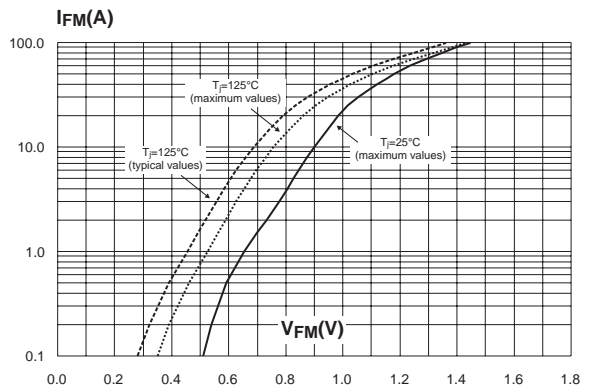

Figure 11: Thermal resistance junction to ambient versus copper surface under tab (epoxy printed board FR4, Cu = 35 μm) (D²PAK)

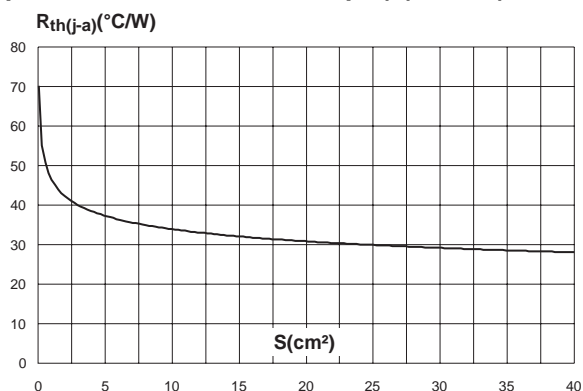

Figure 12: D²PAK Package Mechanical Data

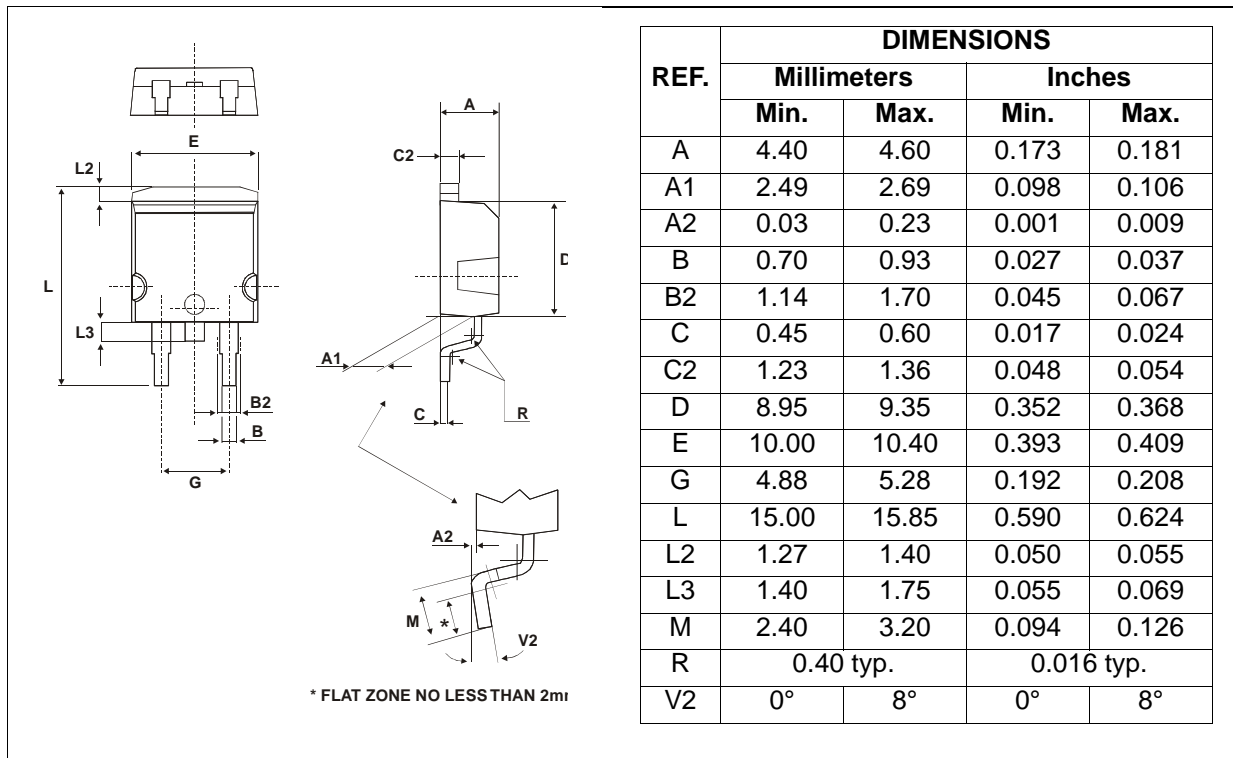

Figure 13: Foot Print Dimensions (in millimeters)

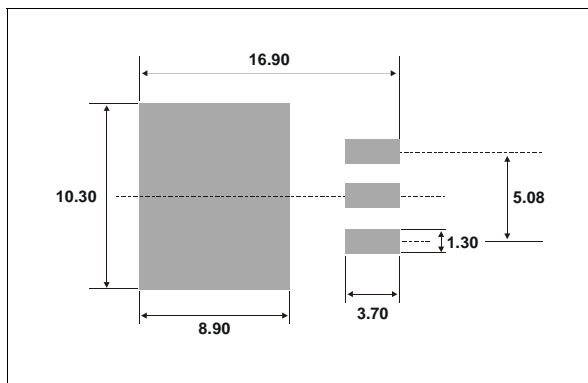

Figure 14: I²PAK Package Mechanical Data

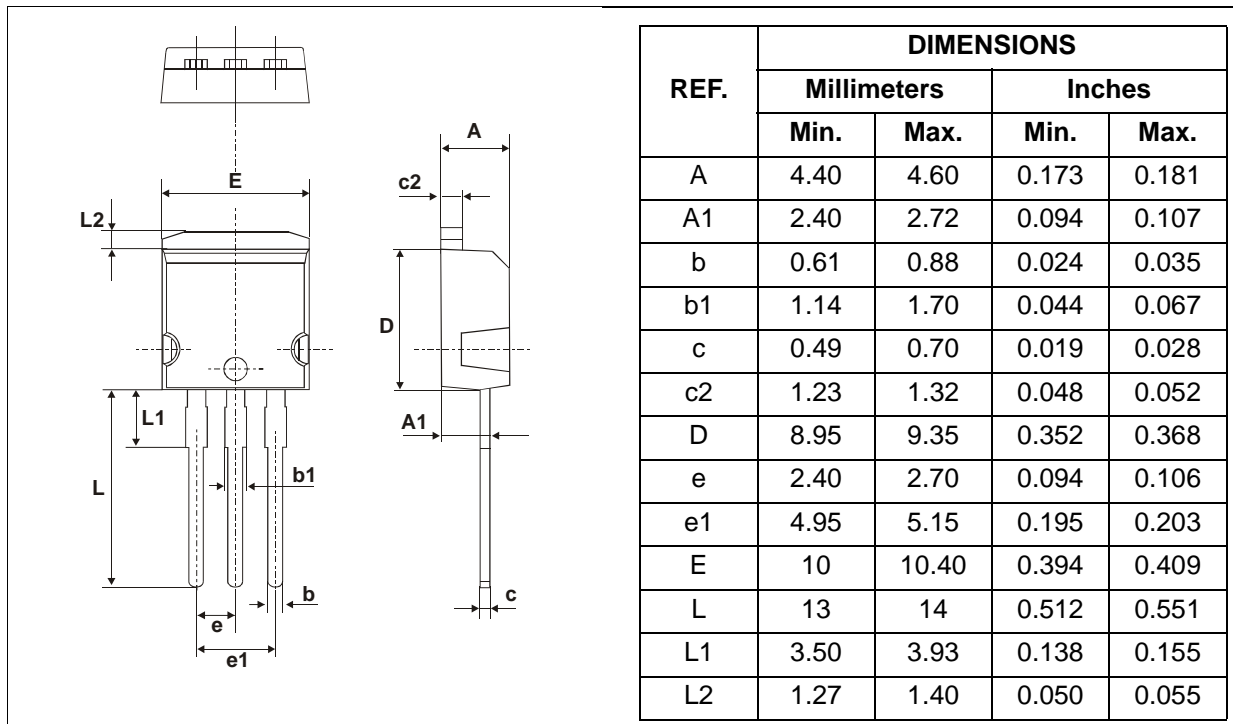

Figure 15: TO-220FPAB Package Mechanical Data

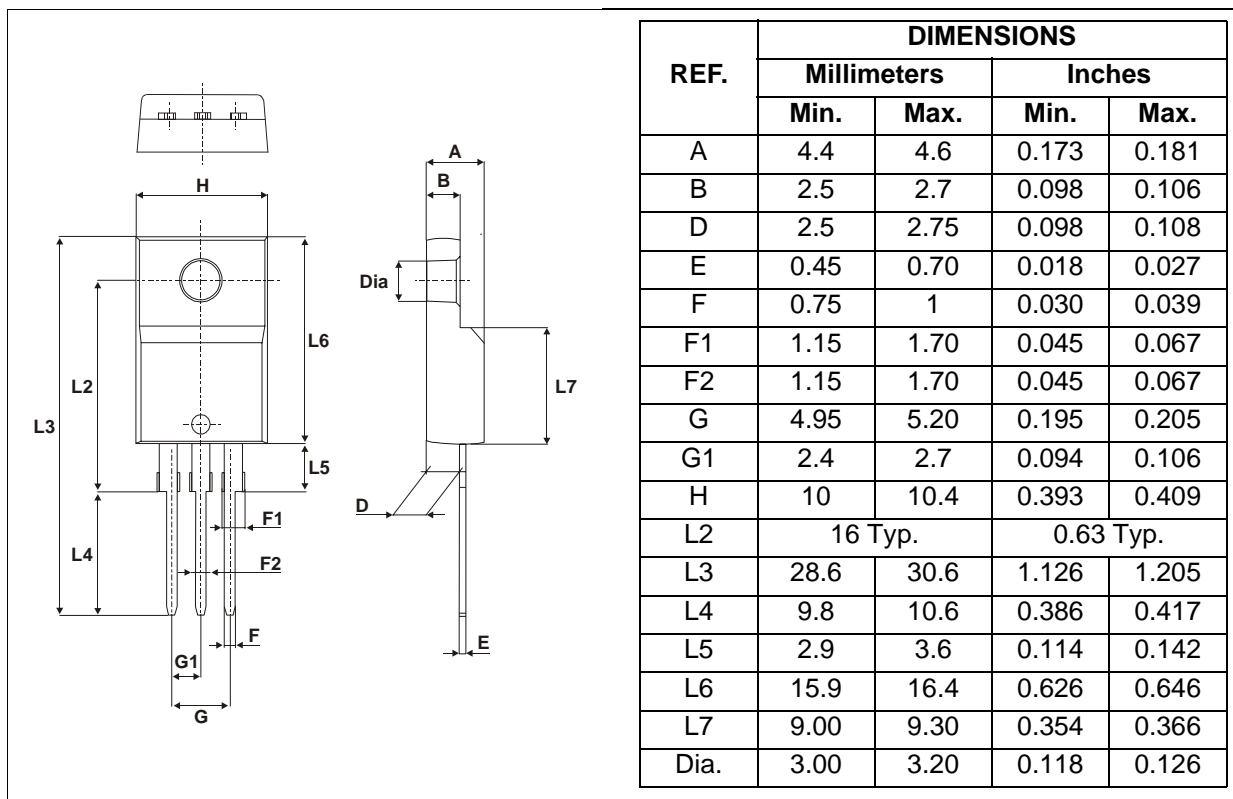

Figure 16: TO-220AB Package Mechanical Data

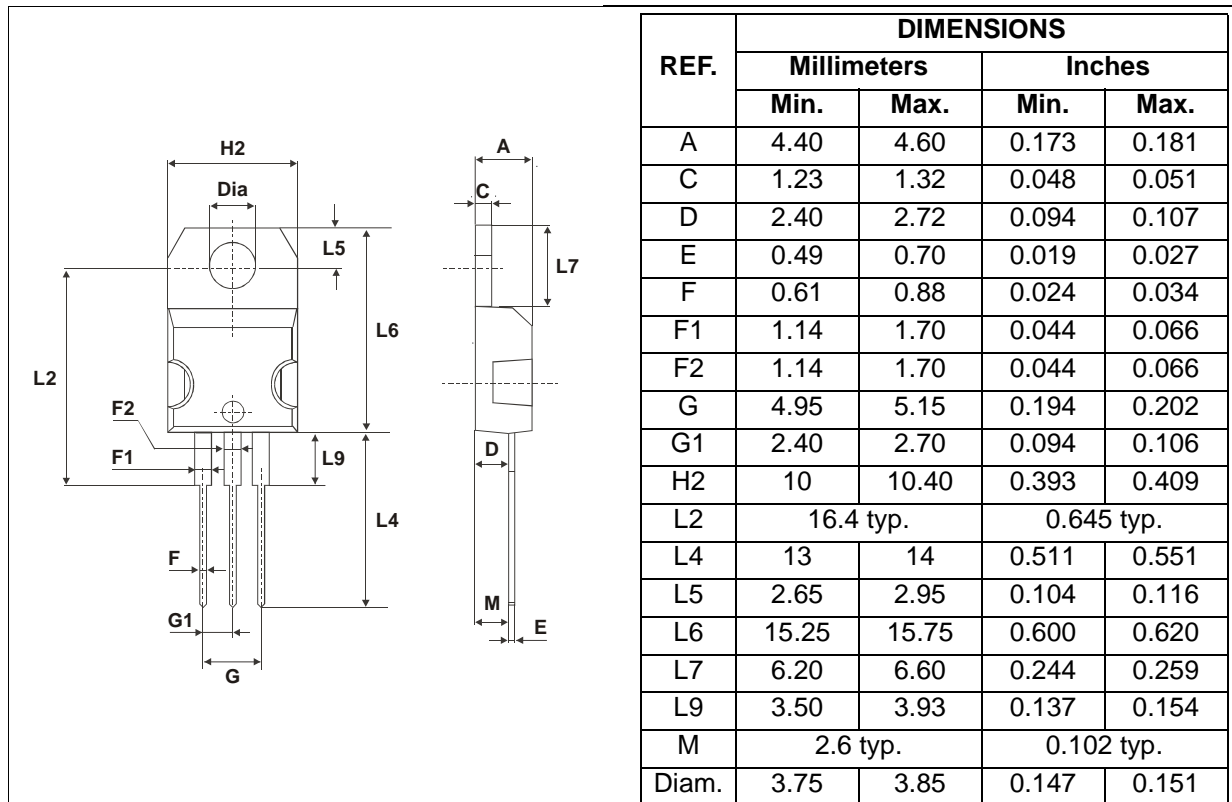

Table 6: Ordering Information

Ordering type	Marking	Package	Weight	Base qty	Delivery mode
STPS20170CT	STPS20170CT	TO-220AB	2.20 g	50	Tube
STPS20170CFP	STPS20170CFP	TO-220FPAB	2 g	50	Tube
STPS20170CR	STPS20170CR	I ² PAK	1.49 g	50	Tube
STPS20170CG	STPS20170CG	D ² PAK	1.48 g	50	Tube
STPS20170CG-TR	STPS20170CG			1000	Tape & reel

- Epoxy meets UL94, V0
- Cooling method: by conduction (C)
- Recommended torque value: 0.8 m.N.
- Maximum torque value: 1.0 m.N.

Table 7: Revision History

Date	Revision	Description of Changes
Mar-2004	1	First issue.
28-Jul-2005	2	TO-220FPAB, I ² PAK and D ² PAK packages added.

Information furnished is believed to be accurate and reliable. However, STMicroelectronics assumes no responsibility for the consequences of use of such information nor for any infringement of patents or other rights of third parties which may result from its use. No license is granted by implication or otherwise under any patent or patent rights of STMicroelectronics. Specifications mentioned in this publication are subject to change without notice. This publication supersedes and replaces all information previously supplied. STMicroelectronics products are not authorized for use as critical components in life support devices or systems without express written approval of STMicroelectronics.

The ST logo is a registered trademark of STMicroelectronics.
All other names are the property of their respective owners

© 2005 STMicroelectronics - All rights reserved

STMicroelectronics group of companies

Australia - Belgium - Brazil - Canada - China - Czech Republic - Finland - France - Germany - Hong Kong - India - Israel - Italy - Japan -
Malaysia - Malta - Morocco - Singapore - Spain - Sweden - Switzerland - United Kingdom - United States of America
www.st.com

Mouser Electronics

Authorized Distributor

Click to View Pricing, Inventory, Delivery & Lifecycle Information:

[STMicroelectronics:](#)

[STPS20170CT](#) [STPS20170CR](#) [STPS20170CFP](#) [STPS20170CG-TR](#) [STPS20170CG](#)