

N-channel 1700 V, 7 Ω typ., 2.6 A PowerMESH™ Power MOSFETs in TO-247 and TO-247 long leads packages

Datasheet - production data

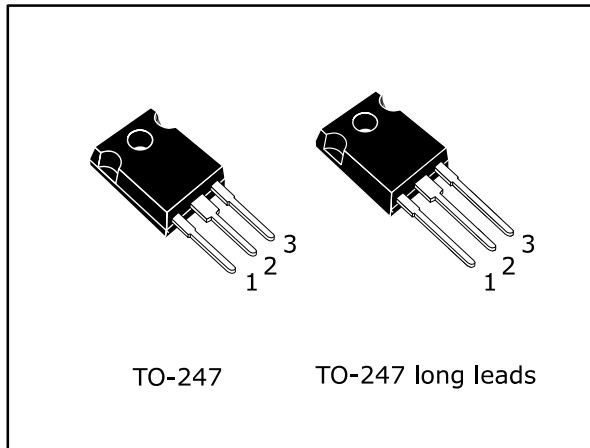

Figure 1: Internal schematic diagram

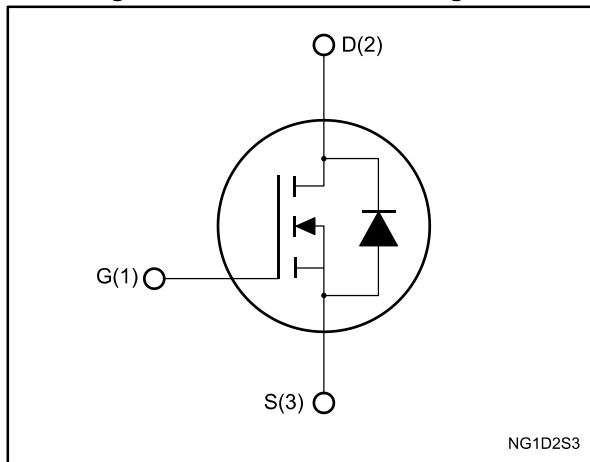

Table 1: Device summary

Order code	Marking	Package	Packing
STW3N170	3N170	TO-247	Tube
STWA3N170		TO-247 long leads	

Features

Order code	V _{DS}	R _{DS(on)} max.	I _D	P _{TOT}
STW3N170	1700 V	13 Ω	2.6 A	160 W
STWA3N170				

- Intrinsic capacitances and Q_g minimized
- High speed switching
- 100% avalanche tested

Applications

- Switching applications

Description

This Power MOSFET is designed using the STMicroelectronics consolidated strip-layout-based MESH OVERLAY™ process. The result is a product that matches or improves on the performance of comparable standard parts from other manufacturers.

Contents

1	Electrical ratings	3
2	Electrical characteristics	4
	2.1 Electrical characteristics (curves)	6
3	Test circuits	8
4	Package information	9
	4.1 TO-247 package information	9
	4.2 TO-247 long leads package information	11
5	Revision history	13

1 Electrical ratings

Table 2: Absolute maximum ratings

Symbol	Parameter	Value	Unit
V_{DS}	Drain-source voltage	1700	V
V_{GS}	Gate-source voltage	± 30	V
I_D	Drain current (continuous) at $T_{case} = 25\text{ }^\circ\text{C}$	2.6	A
	Drain current (continuous) at $T_{case} = 100\text{ }^\circ\text{C}$	1.6	
$I_{DM}^{(1)}$	Drain current (pulsed)	10.4	A
P_{TOT}	Total dissipation at $T_{case} = 25\text{ }^\circ\text{C}$	160	W
I_{AR}	Avalanche current, repetitive or not repetitive	0.8	A
$E_{AS}^{(2)}$	Single pulse avalanche energy	2	mJ
T_{stg}	Storage temperature	-55 to 150	$^\circ\text{C}$
T_j	Operating junction temperature		

Notes:

(1) Pulse width limited by T_{jmax} .

(2) starting $T_j = 25\text{ }^\circ\text{C}$, $I_D = I_{AR}$, $V_{DD} = 50\text{ V}$.

Table 3: Thermal data

Symbol	Parameter	Value	Unit
$R_{thj-case}$	Thermal resistance junction-case	0.78	$^\circ\text{C/W}$
$R_{thj-amb}$	Thermal resistance junction-ambient	50	

2 Electrical characteristics

($T_{\text{case}} = 25\text{ °C}$ unless otherwise specified)

Table 4: Static

Symbol	Parameter	Test conditions	Min.	Typ.	Max.	Unit
$V_{(\text{BR})\text{DSS}}$	Drain-source breakdown voltage	$V_{\text{GS}} = 0\text{ V}$, $I_{\text{D}} = 1\text{ mA}$	1700			V
I_{DSS}	Zero gate voltage drain current	$V_{\text{GS}} = 0\text{ V}$, $V_{\text{DS}} = 1700\text{ V}$			10	μA
		$V_{\text{GS}} = 0\text{ V}$, $V_{\text{DS}} = 1700\text{ V}$, $T_{\text{case}} = 125\text{ °C}$			500	
I_{GSS}	Gate-body leakage current	$V_{\text{DS}} = 0\text{ V}$, $V_{\text{GS}} = \pm 30\text{ V}$			± 100	nA
$V_{\text{GS}(\text{th})}$	Gate threshold voltage	$V_{\text{DS}} = V_{\text{GS}}$, $I_{\text{D}} = 250\text{ }\mu\text{A}$	3	4	5	V
$R_{\text{DS}(\text{on})}$	Static drain-source on-resistance	$V_{\text{GS}} = 10\text{ V}$, $I_{\text{D}} = 1.3\text{ A}$		7	13	Ω

Table 5: Dynamic

Symbol	Parameter	Test conditions	Min.	Typ.	Max.	Unit
C_{iSS}	Input capacitance	$V_{\text{DS}} = 100\text{ V}$, $f = 1\text{ MHz}$, $V_{\text{GS}} = 0\text{ V}$	-	1100	-	pF
C_{OSS}	Output capacitance		-	50	-	
C_{RSS}	Reverse transfer capacitance		-	7	-	
R_{G}	Intrinsic gate resistance	$f = 1\text{ MHz}$, $I_{\text{D}} = 0\text{ A}$	-	3.6	-	Ω
Q_{g}	Total gate charge	$V_{\text{DD}} = 1360\text{ V}$, $I_{\text{D}} = 2.6\text{ A}$, $V_{\text{GS}} = 10\text{ V}$ (see Figure 15: "Test circuit for gate charge behavior")	-	44	-	nC
Q_{gs}	Gate-source charge		-	7	-	
Q_{gd}	Gate-drain charge		-	25	-	

Table 6: Switching times

Symbol	Parameter	Test conditions	Min.	Typ.	Max.	Unit
$t_{\text{d}(\text{on})}$	Turn-on delay time	$V_{\text{DD}} = 850\text{ V}$, $I_{\text{D}} = 1.3\text{ A}$ $R_{\text{G}} = 4.7\text{ }\Omega$, $V_{\text{GS}} = 10\text{ V}$ (see Figure 14: "Test circuit for resistive load switching times" and Figure 19: "Switching time waveform")	-	25	-	ns
t_{r}	Rise time		-	9	-	
$t_{\text{d}(\text{off})}$	Turn-off delay time		-	51	-	
t_{f}	Fall time		-	53	-	

Table 7: Source-drain diode

Symbol	Parameter	Test conditions	Min.	Typ.	Max.	Unit
I_{SD}	Source-drain current	$T_j = 25\text{ °C}$	-		2.6	A
I_{SDM}	Source-drain current (pulsed)	$T_j = 25\text{ °C}$	-		10.4	A
$V_{SD}^{(1)}$	Forward on voltage	$V_{GS} = 0\text{ V}$, $I_{SD} = 2.6\text{ A}$	-		1.5	V
t_{rr}	Reverse recovery time	$I_{SD} = 2.6\text{ A}$, $di/dt = 100\text{ A}/\mu\text{s}$, $V_{DD} = 60\text{ V}$ (see <i>Figure 16: "Test circuit for inductive load switching and diode recovery times")</i>)	-	1.58		μs
Q_{rr}	Reverse recovery charge		-	6		μC
I_{RRM}	Reverse recovery current		-	7.9		A
t_{rr}	Reverse recovery time	$I_{SD} = 2.6\text{ A}$, $di/dt = 100\text{ A}/\mu\text{s}$, $V_{DD} = 60\text{ V}$, $T_j = 150\text{ °C}$ (see <i>Figure 16: "Test circuit for inductive load switching and diode recovery times")</i>)	-	2.12		μs
Q_{rr}	Reverse recovery charge		-	8.8		μC
I_{RRM}	Reverse recovery current		-	8.3		A

Notes:

⁽¹⁾ Pulse test: pulse duration = 300 μs , duty cycle 1.5%.

2.1 Electrical characteristics (curves)

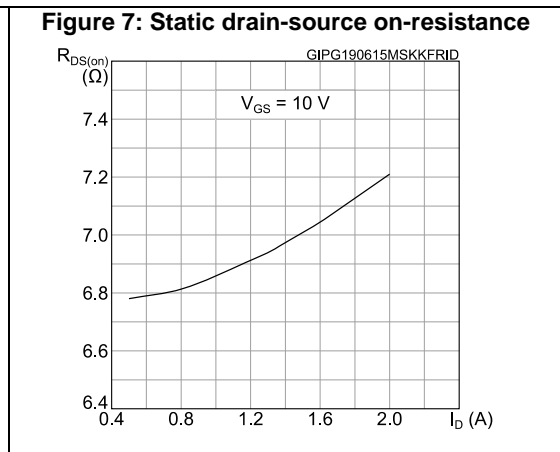
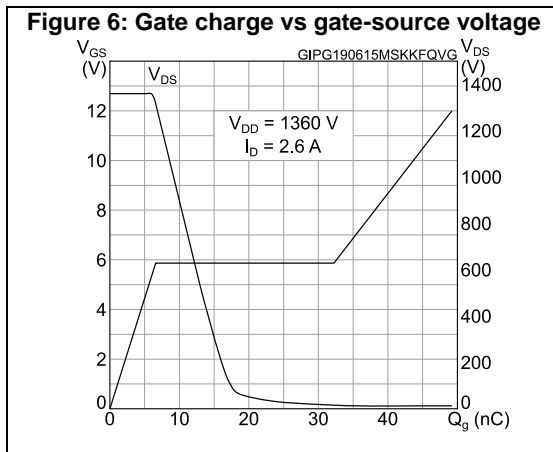
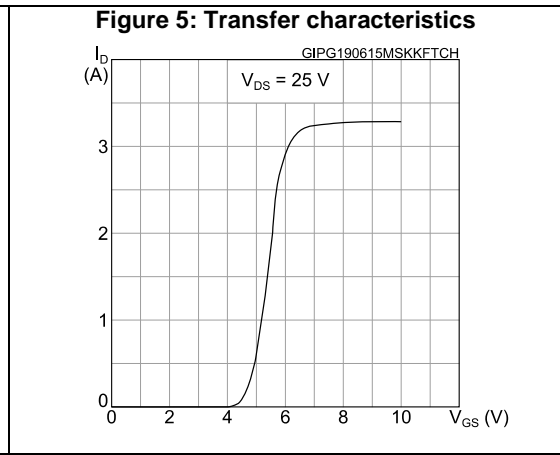
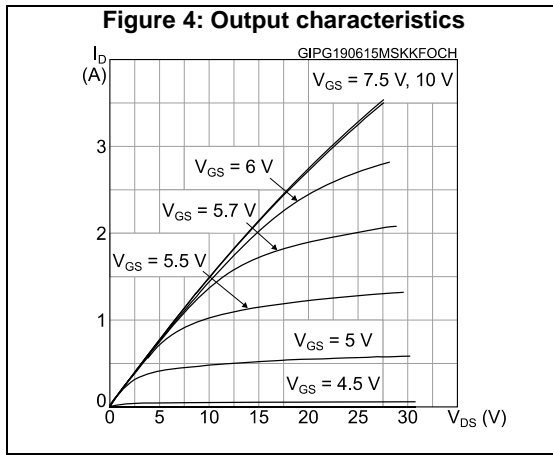
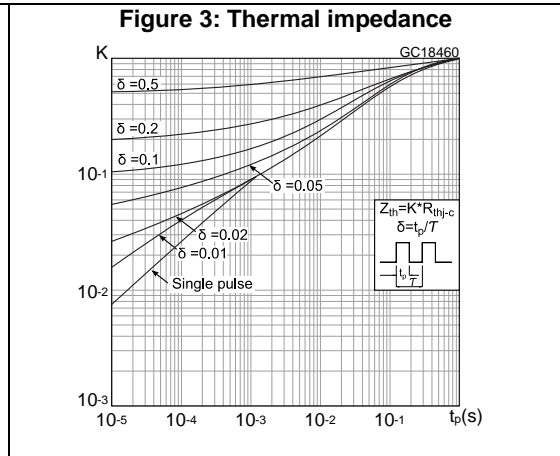
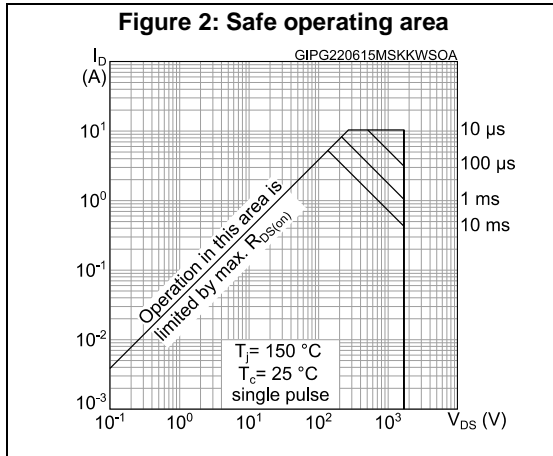

Figure 8: Capacitance variations

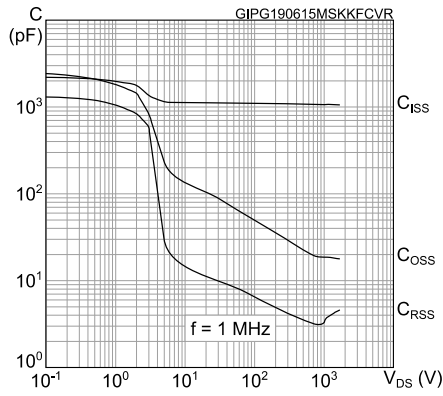

Figure 9: Normalized gate threshold voltage vs temperature

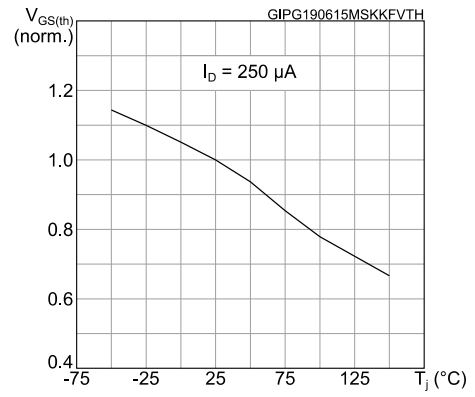

Figure 10: Normalized on-resistance vs temperature

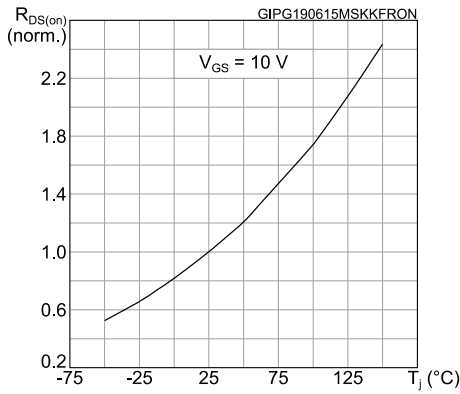

Figure 11: Normalized V(BR)DSS vs temperature

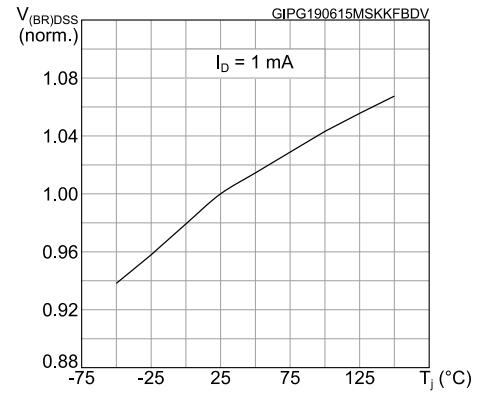

Figure 12: Output capacitance stored energy

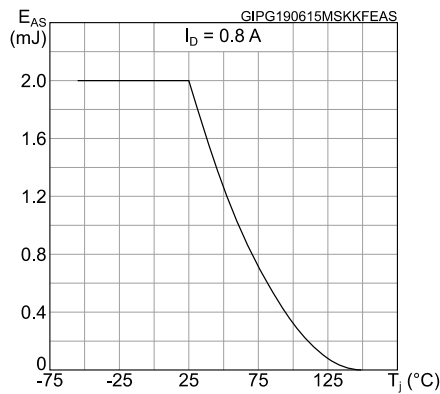
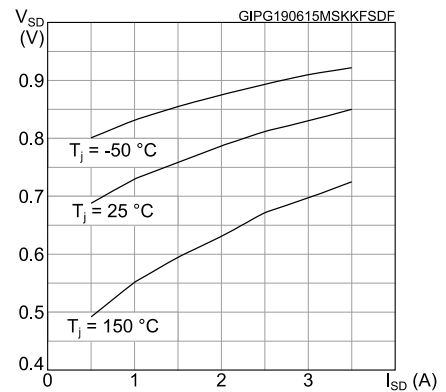

Figure 13: Source-drain diode forward characteristics



3 Test circuits

Figure 14: Test circuit for resistive load switching times



AM01468v1

Figure 15: Test circuit for gate charge behavior



AM01469v1

Figure 16: Test circuit for inductive load switching and diode recovery times



AM01470v1

Figure 17: Unclamped inductive load test circuit



AM01471v1

Figure 18: Unclamped inductive waveform



AM01472v1

Figure 19: Switching time waveform



AM01473v1

4 Package information

In order to meet environmental requirements, ST offers these devices in different grades of ECOPACK® packages, depending on their level of environmental compliance. ECOPACK® specifications, grade definitions and product status are available at: www.st.com. ECOPACK® is an ST trademark.

4.1 TO-247 package information

Figure 20: TO-247 package outline

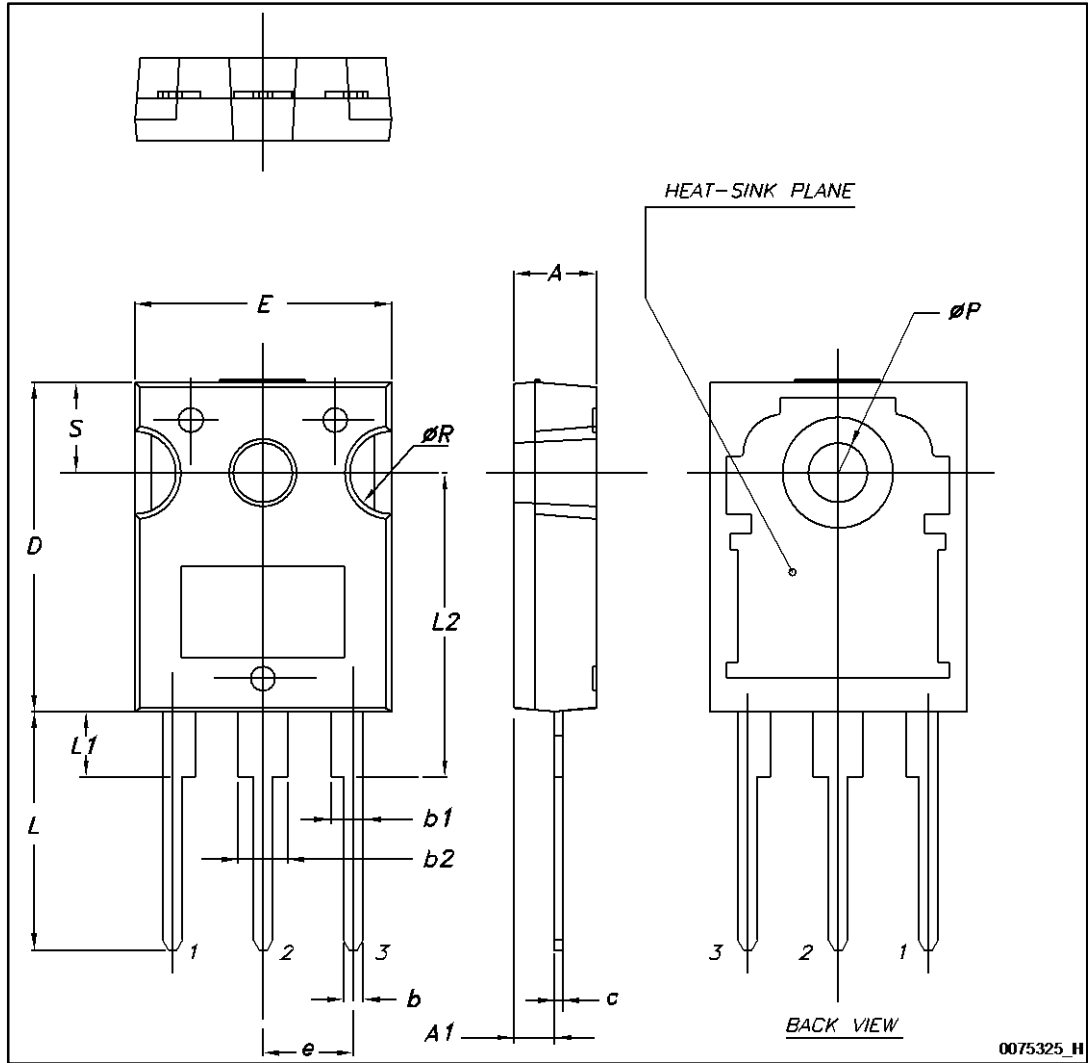
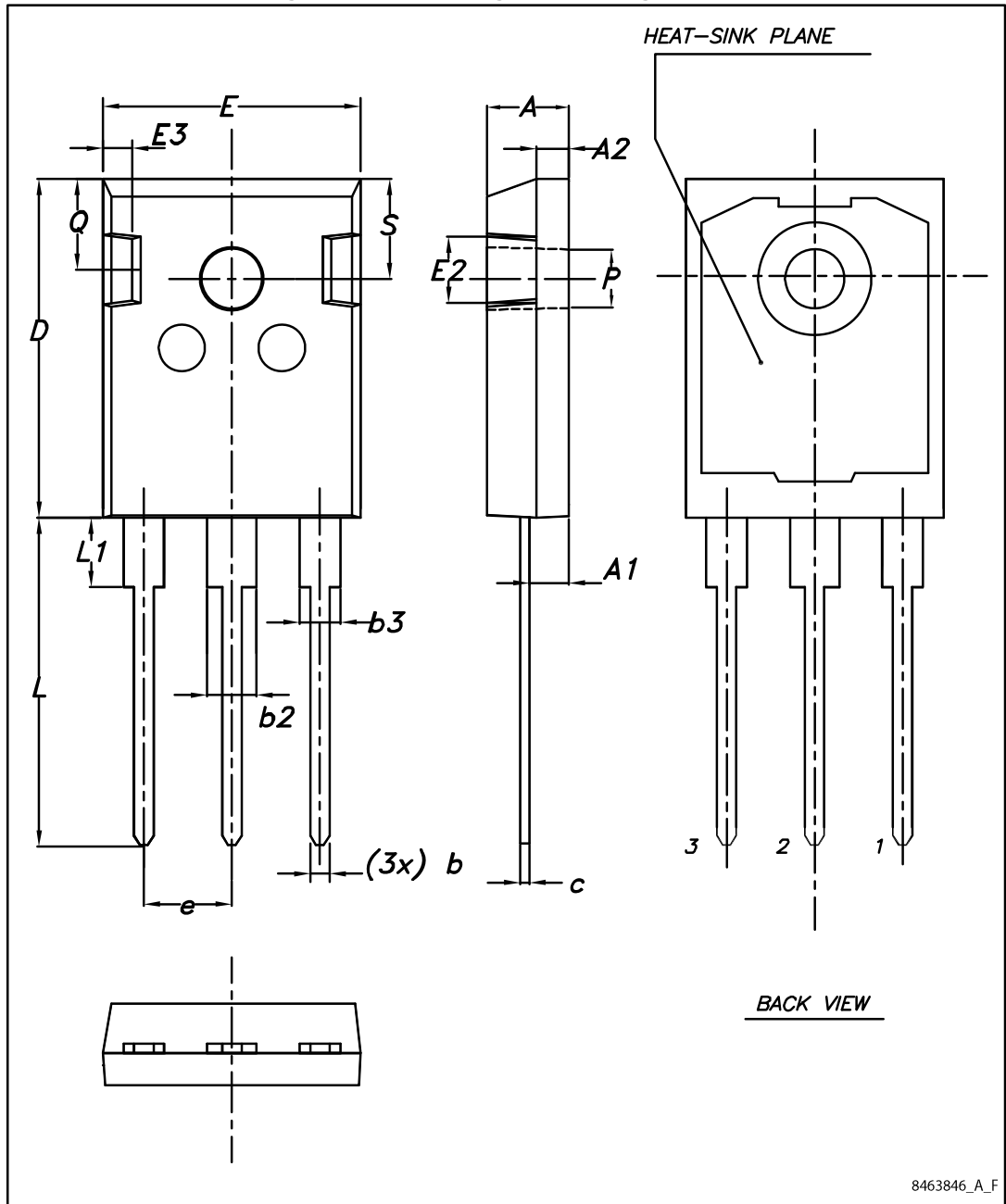

Table 8: TO-247 package mechanical data

Dim.	mm.		
	Min.	Typ.	Max.
A	4.85		5.15
A1	2.20		2.60
b	1.0		1.40
b1	2.0		2.40
b2	3.0		3.40
c	0.40		0.80
D	19.85		20.15
E	15.45		15.75
e	5.30	5.45	5.60
L	14.20		14.80
L1	3.70		4.30
L2		18.50	
ØP	3.55		3.65
ØR	4.50		5.50
S	5.30	5.50	5.70

4.2 TO-247 long leads package information

Figure 21: TO-247 long leads package outline



8463846_A_F

Table 9: TO-247 long leads package mechanical data

Dim.	mm.		
	Min.	Typ.	Max.
A	4.90	5.00	5.10
A1	2.31	2.41	2.51
A2	1.90	2.00	2.10
b	1.16		1.26
b2			3.25
b3			2.25
c	0.59		0.66
D	20.90	21.00	21.10
E	15.70	15.80	15.90
E2	4.90	5.00	5.10
E3	2.40	2.50	2.60
e	5.34	5.44	5.54
L	19.80	19.92	20.10
L1			4.30
P	3.50	3.60	3.70
Q	5.60		6.00
S	6.05	6.15	6.25

5 Revision history

Table 10: Document revision history

Date	Revision	Changes
14-Sep-2015	1	First release.

IMPORTANT NOTICE – PLEASE READ CAREFULLY

STMicroelectronics NV and its subsidiaries ("ST") reserve the right to make changes, corrections, enhancements, modifications, and improvements to ST products and/or to this document at any time without notice. Purchasers should obtain the latest relevant information on ST products before placing orders. ST products are sold pursuant to ST's terms and conditions of sale in place at the time of order acknowledgement.

Purchasers are solely responsible for the choice, selection, and use of ST products and ST assumes no liability for application assistance or the design of Purchasers' products.

No license, express or implied, to any intellectual property right is granted by ST herein.

Resale of ST products with provisions different from the information set forth herein shall void any warranty granted by ST for such product.

ST and the ST logo are trademarks of ST. All other product or service names are the property of their respective owners.

Information in this document supersedes and replaces information previously supplied in any prior versions of this document.

© 2015 STMicroelectronics – All rights reserved

Mouser Electronics

Authorized Distributor

Click to View Pricing, Inventory, Delivery & Lifecycle Information:

[STMicroelectronics:](#)

[STW3N170](#)