



# STY112N65M5

N-channel 650 V, 0.019  $\Omega$ , 96 A, MDmesh™ V Power MOSFET  
in Max247 package

Datasheet — production data

## Features

Order code	$V_{DSS}$ @ $T_{jMAX}$	$R_{DS(on)}$ max	$I_D$
STY112N65M5	710 V	< 0.022 $\Omega$	96 A

- Higher  $V_{DSS}$  rating
- Higher dv/dt capability
- Excellent switching performance
- Easy to drive
- 100% avalanche tested

## Applications

- Switching applications

## Description

This device is an N-channel MDmesh™ V Power MOSFET based on an innovative proprietary vertical process technology, which is combined with STMicroelectronics' well-known PowerMESH™ horizontal layout structure. The resulting product has extremely low on-resistance, which is unmatched among silicon-based Power MOSFETs, making it especially suitable for applications which require superior power density and outstanding efficiency.

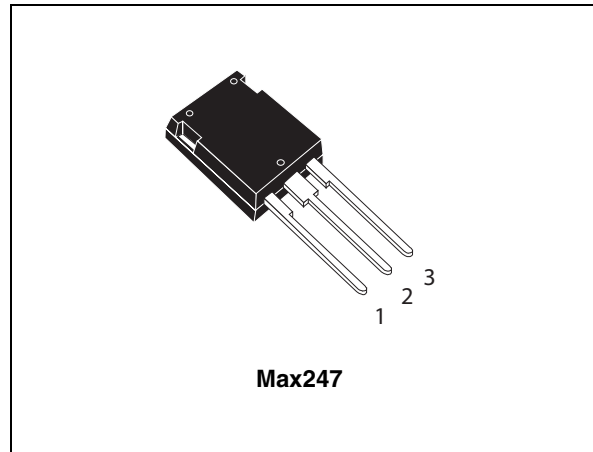

Figure 1. Internal schematic diagram

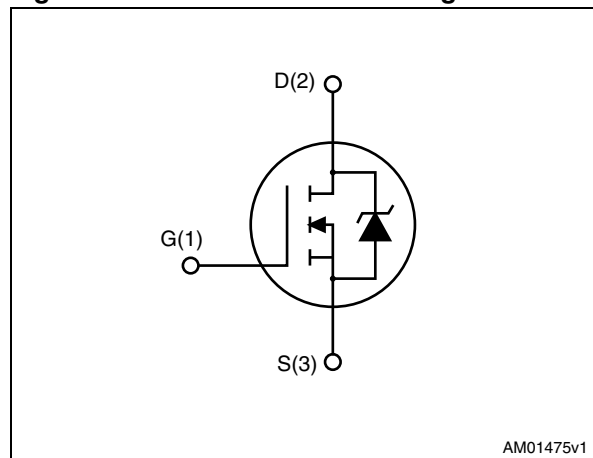

Table 1. Device summary

Order code	Marking	Package	Packaging
STY112N65M5	112N65M5	Max247	Tube

## Contents

<b>1</b>	<b>Electrical ratings</b> .....	<b>3</b>
<b>2</b>	<b>Electrical characteristics</b> .....	<b>4</b>
	2.1 Electrical characteristics (curves) .....	6
<b>3</b>	<b>Test circuits</b> .....	<b>8</b>
<b>4</b>	<b>Package mechanical data</b> .....	<b>9</b>
<b>5</b>	<b>Revision history</b> .....	<b>11</b>

# 1 Electrical ratings

**Table 2. Absolute maximum ratings**

Symbol	Parameter	Value	Unit
$V_{GS}$	Gate- source voltage	$\pm 25$	V
$I_D$	Drain current (continuous) at $T_C = 25\text{ }^\circ\text{C}$	96	A
$I_D$	Drain current (continuous) at $T_C = 100\text{ }^\circ\text{C}$	61	A
$I_{DM}^{(1)}$	Drain current (pulsed)	384	A
$P_{TOT}$	Total dissipation at $T_C = 25\text{ }^\circ\text{C}$	625	W
$I_{AR}$	Max current during repetitive or single pulse avalanche (pulse width limited by $T_{JMAX}$ )	17	A
$E_{AS}$	Single pulse avalanche energy (starting $T_j = 25\text{ }^\circ\text{C}$ , $I_D = I_{AR}$ , $V_{DD} = 50\text{V}$ )	2400	mJ
$dv/dt^{(2)}$	Peak diode recovery voltage slope	15	V/ns
$T_{stg}$	Storage temperature	- 55 to 150	$^\circ\text{C}$
$T_j$	Max. operating junction temperature	150	$^\circ\text{C}$

1. Pulse width limited by safe operating area.

2.  $I_{SD} \leq 96\text{ A}$ ,  $di/dt = 400\text{ A}/\mu\text{s}$ ,  $V_{DD} = 400\text{ V}$ , peak  $V_{DS} < V_{(BR)DSS}$ .

**Table 3. Thermal data**

Symbol	Parameter	Value	Unit
$R_{thj-case}$	Thermal resistance junction-case max	0.2	$^\circ\text{C}/\text{W}$
$R_{thj-amb}$	Thermal resistance junction-ambient max	30	$^\circ\text{C}/\text{W}$
$T_l$	Maximum lead temperature for soldering purpose	300	$^\circ\text{C}$

## 2 Electrical characteristics

( $T_C = 25\text{ °C}$  unless otherwise specified)

**Table 4. On /off states**

Symbol	Parameter	Test conditions	Min.	Typ.	Max.	Unit
$V_{(BR)DSS}$	Drain-source breakdown voltage	$I_D = 1\text{ mA}$ , $V_{GS} = 0$	650			V
$I_{DSS}$	Zero gate voltage drain current ( $V_{GS} = 0$ )	$V_{DS} = 650\text{ V}$ $V_{DS} = 650\text{ V}$ , $T_C = 125\text{ °C}$			10 100	$\mu\text{A}$ $\mu\text{A}$
$I_{GSS}$	Gate-body leakage current ( $V_{DS} = 0$ )	$V_{GS} = \pm 25\text{ V}$			$\pm 100$	nA
$V_{GS(th)}$	Gate threshold voltage	$V_{DS} = V_{GS}$ , $I_D = 250\text{ }\mu\text{A}$	3	4	5	V
$R_{DS(on)}$	Static drain-source on resistance	$V_{GS} = 10\text{ V}$ , $I_D = 48\text{ A}$		0.019	0.022	$\Omega$

**Table 5. Dynamic**

Symbol	Parameter	Test conditions	Min.	Typ.	Max.	Unit
$C_{iss}$ $C_{oss}$ $C_{rss}$	Input capacitance Output capacitance Reverse transfer capacitance	$V_{DS} = 100\text{ V}$ , $f = 1\text{ MHz}$ , $V_{GS} = 0$	-	16870 365 7	-	pF pF pF
$C_{o(tr)}^{(1)}$	Equivalent capacitance time related	$V_{GS} = 0$ , $V_{DS} = 0\text{ to }520\text{ V}$	-	1333	-	pF
$C_{o(er)}^{(2)}$	Equivalent capacitance energy related	$V_{GS} = 0$ , $V_{DS} = 0\text{ to }520\text{ V}$	-	350	-	pF
$R_G$	Intrinsic gate resistance	$f = 1\text{ MHz}$ open drain	-	1.26	-	$\Omega$
$Q_g$ $Q_{gs}$ $Q_{gd}$	Total gate charge Gate-source charge Gate-drain charge	$V_{DD} = 520\text{ V}$ , $I_D = 48\text{ A}$ , $V_{GS} = 10\text{ V}$ (see <a href="#">Figure 15</a> )	-	350 97 118	-	nC nC nC

- $C_{o(tr)}$  is a constant capacitance value that gives the same charging time as  $C_{oss}$  while  $V_{DS}$  is rising from 0 to 80%  $V_{DSS}$ .
- $C_{o(er)}$  is a constant capacitance value that gives the same stored energy as  $C_{oss}$  while  $V_{DS}$  is rising from 0 to 80%  $V_{DSS}$ .

**Table 6. Switching times**

Symbol	Parameter	Test conditions	Min.	Typ.	Max.	Unit
$t_{d(v)}$	Voltage delay time	$V_{DD} = 400\text{ V}$ , $I_D = 64\text{ A}$ ,		267		ns
$t_{r(v)}$	Voltage rise time	$R_G = 4.7\ \Omega$ , $V_{GS} = 10\text{ V}$		79		ns
$t_{f(i)}$	Current fall time	(see <a href="#">Figure 16</a> )	-	53	-	ns
$t_{c(off)}$	Crossing time	(see <a href="#">Figure 19</a> )		140		ns

**Table 7. Source drain diode**

Symbol	Parameter	Test conditions	Min.	Typ.	Max.	Unit
$I_{SD}$	Source-drain current				96	A
$I_{SDM}^{(1)}$	Source-drain current (pulsed)		-		384	A
$V_{SD}^{(2)}$	Forward on voltage	$I_{SD} = 96\text{ A}$ , $V_{GS} = 0$	-		1.5	V
$t_{rr}$	Reverse recovery time	$I_{SD} = 96\text{ A}$ , $di/dt = 100\text{ A}/\mu\text{s}$		570		ns
$Q_{rr}$	Reverse recovery charge	$V_{DD} = 100\text{ V}$ (see <a href="#">Figure 16</a> )	-	17		$\mu\text{C}$
$I_{RRM}$	Reverse recovery current			60		A
$t_{rr}$	Reverse recovery time	$I_{SD} = 96\text{ A}$ , $di/dt = 100\text{ A}/\mu\text{s}$		695		ns
$Q_{rr}$	Reverse recovery charge	$V_{DD} = 100\text{ V}$ , $T_j = 150\text{ }^\circ\text{C}$	-	26		$\mu\text{C}$
$I_{RRM}$	Reverse recovery current	(see <a href="#">Figure 16</a> )		73		A

1. Pulse width limited by safe operating area

2. Pulsed: pulse duration = 300  $\mu\text{s}$ , duty cycle 1.5%

## 2.1 Electrical characteristics (curves)

Figure 2. Safe operating area

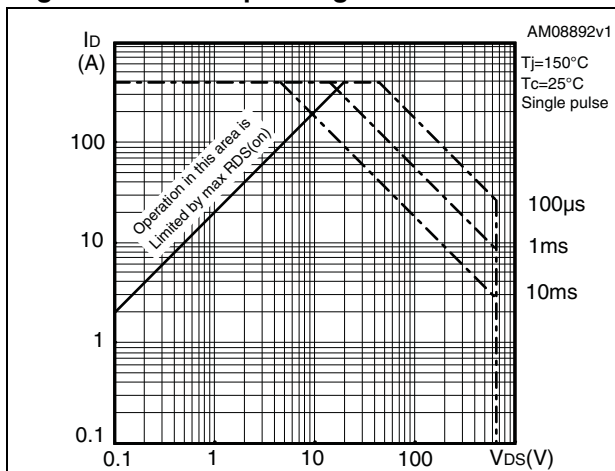

Figure 3. Thermal impedance

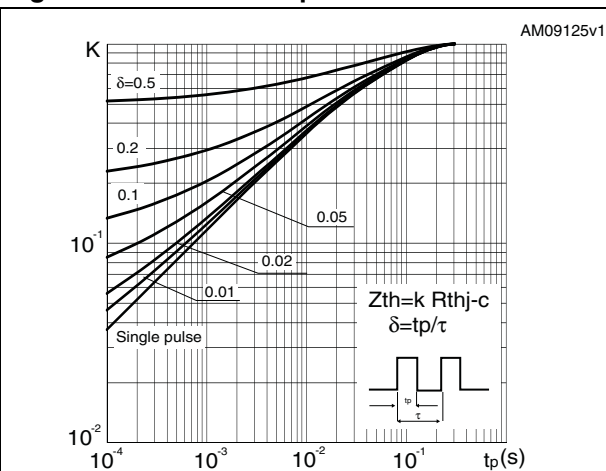

Figure 4. Output characteristics

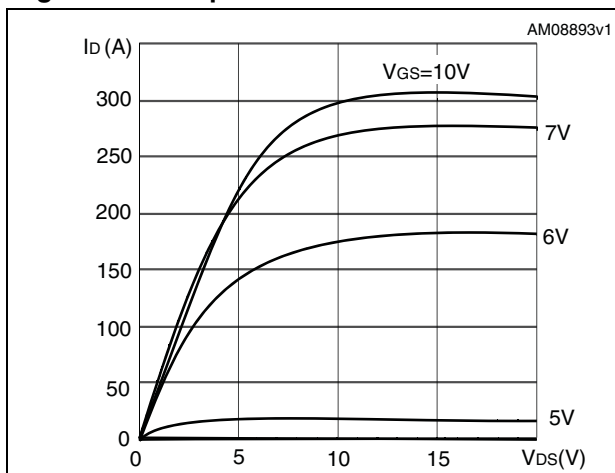

Figure 5. Transfer characteristics

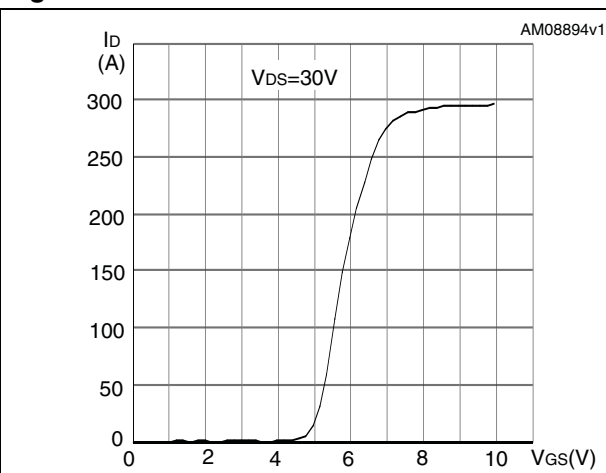

Figure 6. Normalized  $V_{DS}$  vs temperature

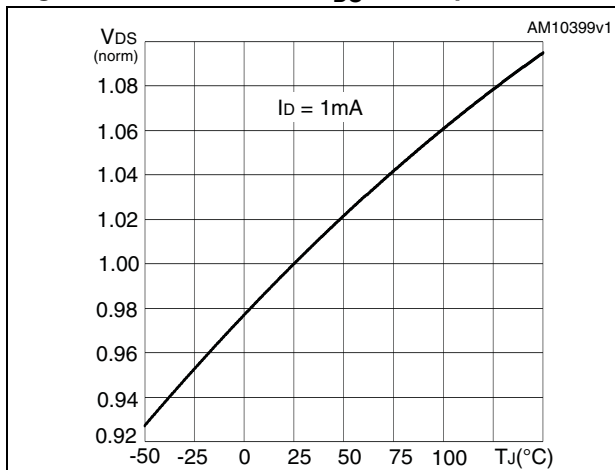

Figure 7. Static drain-source on resistance

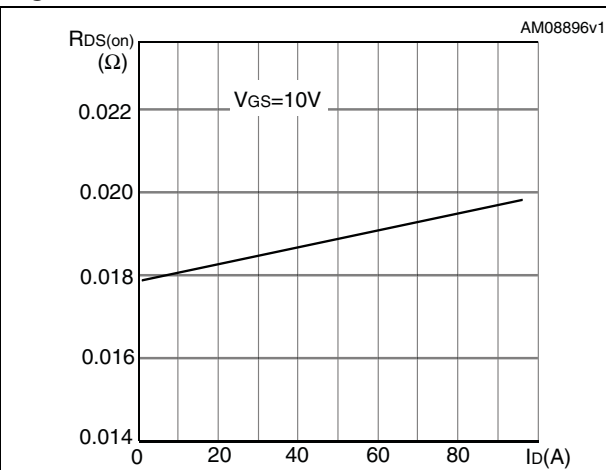

Figure 8. Gate charge vs gate-source voltage Figure 9. Capacitance variations

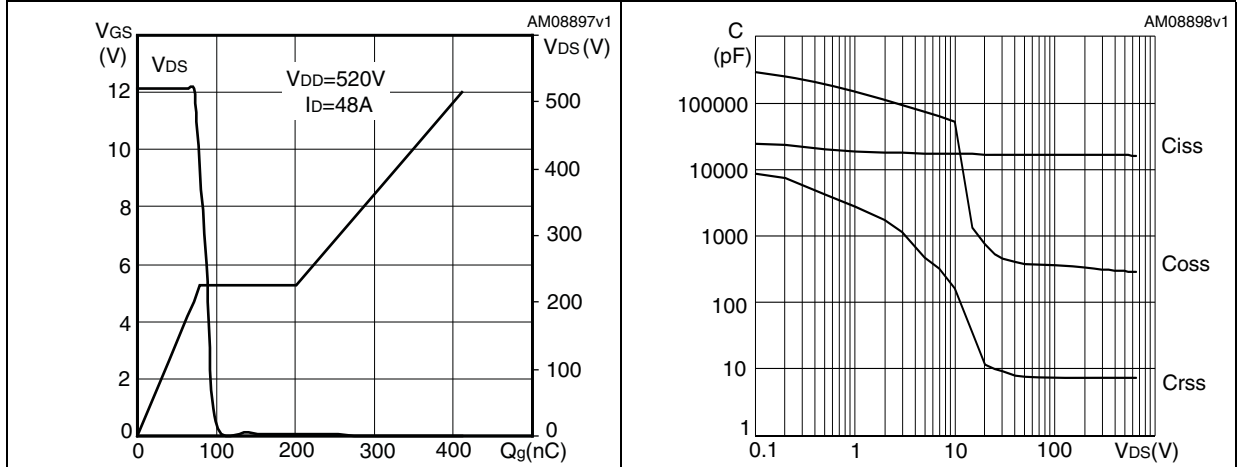

Figure 10. Normalized gate threshold voltage vs temperature Figure 11. Normalized on resistance vs temperature

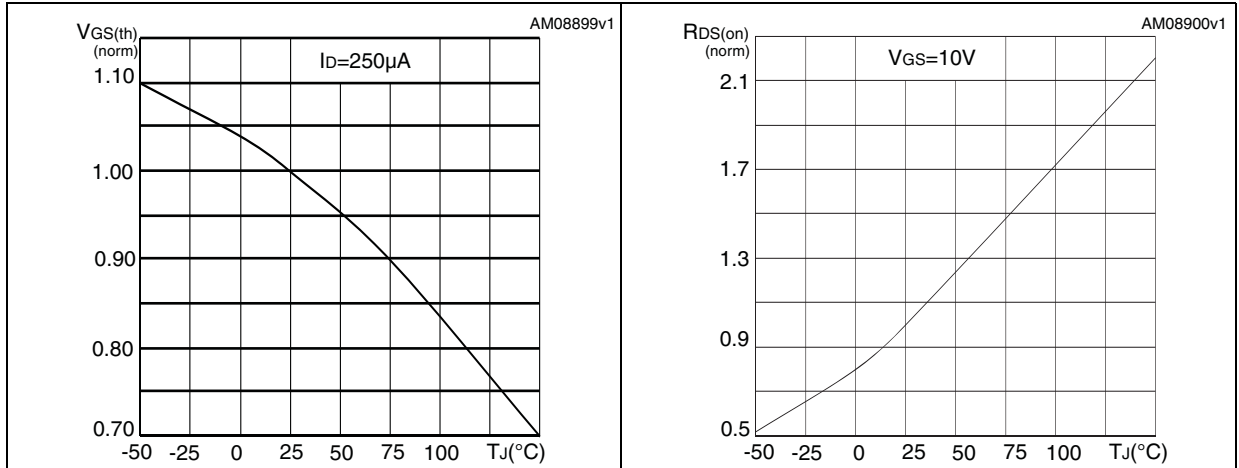
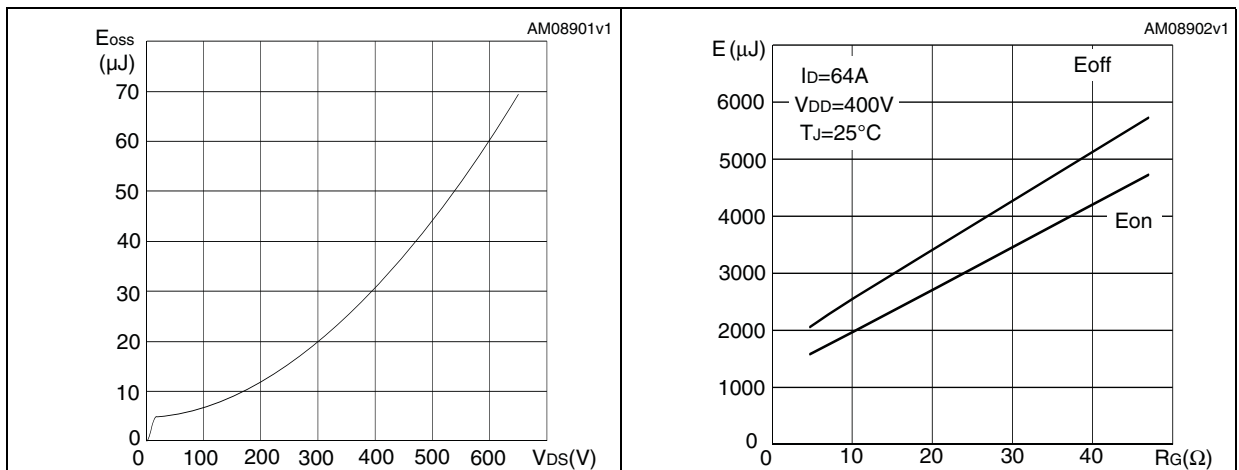

Figure 12. Output capacitance stored energy Figure 13. Switching losses vs gate resistance (1)



1.  $E_{on}$  including reverse recovery of a SiC diode

### 3 Test circuits

**Figure 14. Switching times test circuit for resistive load**



AM01468v1

**Figure 15. Gate charge test circuit**



AM01469v1

**Figure 16. Test circuit for inductive load switching and diode recovery times**



AM01470v1

**Figure 17. Unclamped inductive load test circuit**



AM01471v1

**Figure 18. Unclamped inductive waveform**

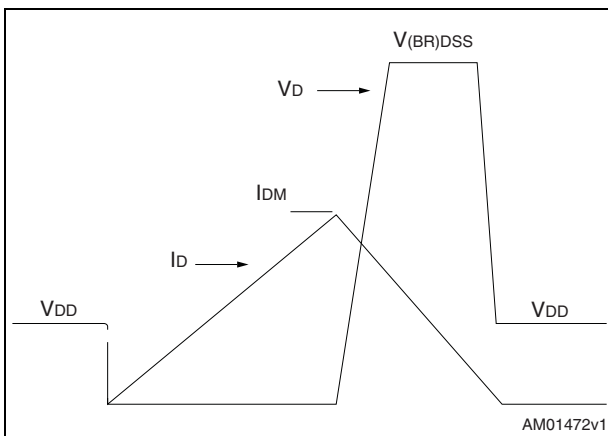

AM01472v1

**Figure 19. Switching time waveform**

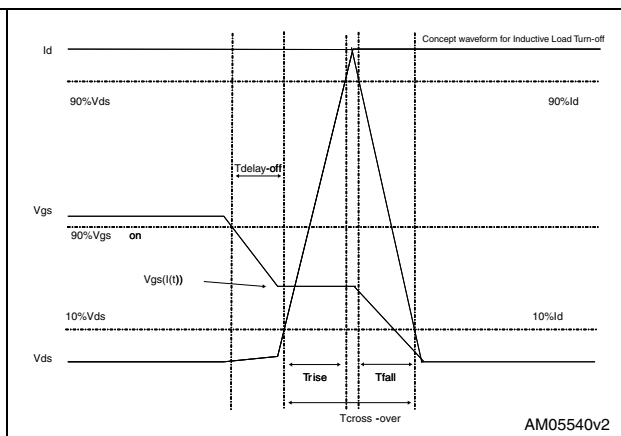

AM05540v2



## 4 Package mechanical data

In order to meet environmental requirements, ST offers these devices in different grades of ECOPACK® packages, depending on their level of environmental compliance. ECOPACK® specifications, grade definitions and product status are available at: [www.st.com](http://www.st.com). ECOPACK® is an ST trademark.

**Table 8. Max247 mechanical data**

Dim.	mm		
	Min.	Typ.	Max.
A	4.70		5.30
A1	2.20		2.60
b	1.00		1.40
b1	2.00		2.40
b2	3.00		3.40
c	0.40		0.80
D	19.70		20.30
e	5.35		5.55
E	15.30		15.90
L	14.20		15.20
L1	3.70		4.30

Figure 20. Max247 drawing

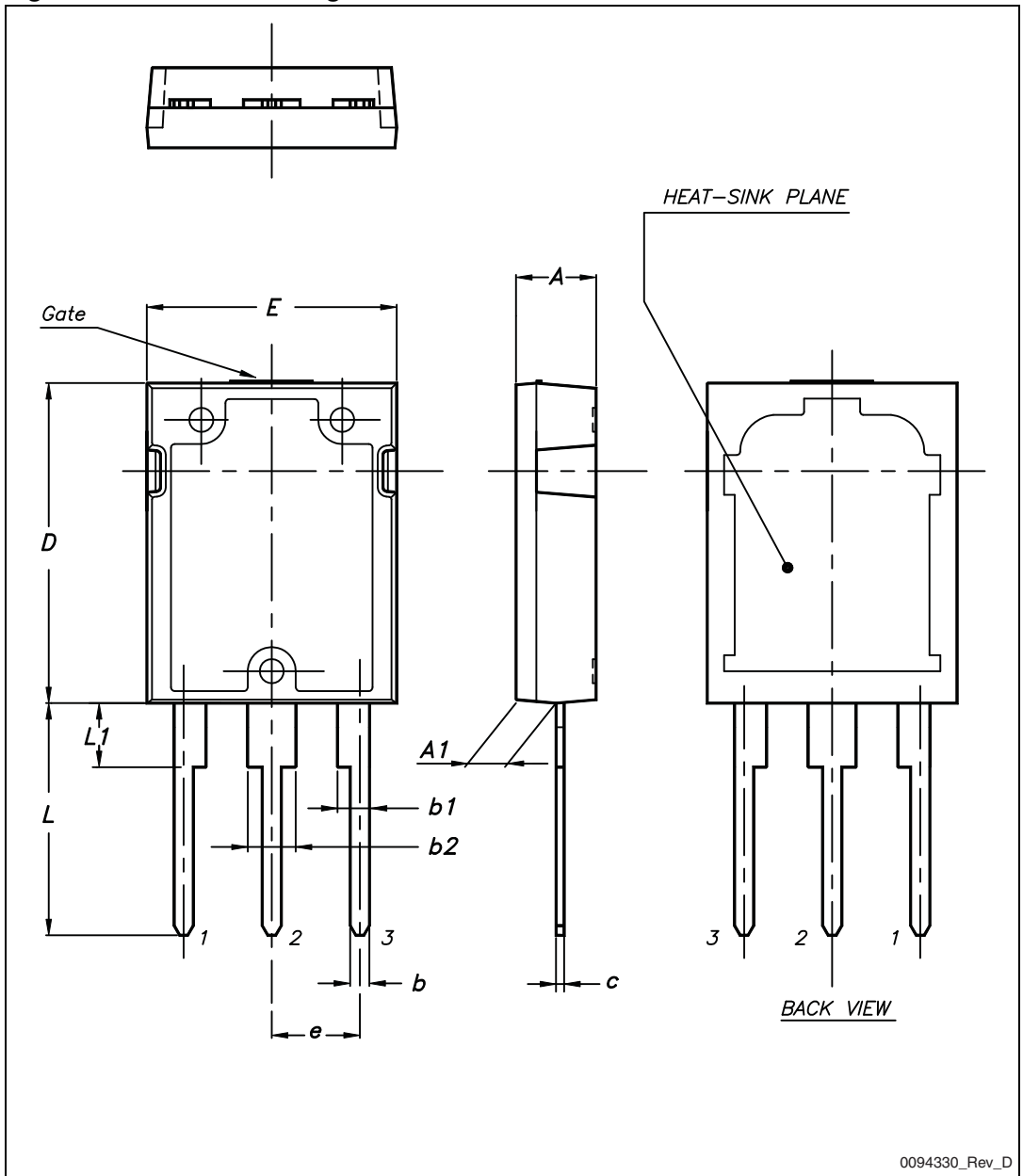

## 5 Revision history

**Table 9. Document revision history**

Date	Revision	Changes
20-Jan-2009	1	First release.
20-May-2011	2	Document status promoted from preliminary data to datasheet.
03-May-2012	3	<i>Section 4: Package mechanical data</i> has been updated.

**Please Read Carefully:**

Information in this document is provided solely in connection with ST products. STMicroelectronics NV and its subsidiaries ("ST") reserve the right to make changes, corrections, modifications or improvements, to this document, and the products and services described herein at any time, without notice.

All ST products are sold pursuant to ST's terms and conditions of sale.

Purchasers are solely responsible for the choice, selection and use of the ST products and services described herein, and ST assumes no liability whatsoever relating to the choice, selection or use of the ST products and services described herein.

No license, express or implied, by estoppel or otherwise, to any intellectual property rights is granted under this document. If any part of this document refers to any third party products or services it shall not be deemed a license grant by ST for the use of such third party products or services, or any intellectual property contained therein or considered as a warranty covering the use in any manner whatsoever of such third party products or services or any intellectual property contained therein.

**UNLESS OTHERWISE SET FORTH IN ST'S TERMS AND CONDITIONS OF SALE ST DISCLAIMS ANY EXPRESS OR IMPLIED WARRANTY WITH RESPECT TO THE USE AND/OR SALE OF ST PRODUCTS INCLUDING WITHOUT LIMITATION IMPLIED WARRANTIES OF MERCHANTABILITY, FITNESS FOR A PARTICULAR PURPOSE (AND THEIR EQUIVALENTS UNDER THE LAWS OF ANY JURISDICTION), OR INFRINGEMENT OF ANY PATENT, COPYRIGHT OR OTHER INTELLECTUAL PROPERTY RIGHT.**

**UNLESS EXPRESSLY APPROVED IN WRITING BY TWO AUTHORIZED ST REPRESENTATIVES, ST PRODUCTS ARE NOT RECOMMENDED, AUTHORIZED OR WARRANTED FOR USE IN MILITARY, AIR CRAFT, SPACE, LIFE SAVING, OR LIFE SUSTAINING APPLICATIONS, NOR IN PRODUCTS OR SYSTEMS WHERE FAILURE OR MALFUNCTION MAY RESULT IN PERSONAL INJURY, DEATH, OR SEVERE PROPERTY OR ENVIRONMENTAL DAMAGE. ST PRODUCTS WHICH ARE NOT SPECIFIED AS "AUTOMOTIVE GRADE" MAY ONLY BE USED IN AUTOMOTIVE APPLICATIONS AT USER'S OWN RISK.**

Resale of ST products with provisions different from the statements and/or technical features set forth in this document shall immediately void any warranty granted by ST for the ST product or service described herein and shall not create or extend in any manner whatsoever, any liability of ST.

ST and the ST logo are trademarks or registered trademarks of ST in various countries.

Information in this document supersedes and replaces all information previously supplied.

The ST logo is a registered trademark of STMicroelectronics. All other names are the property of their respective owners.

© 2012 STMicroelectronics - All rights reserved

STMicroelectronics group of companies

Australia - Belgium - Brazil - Canada - China - Czech Republic - Finland - France - Germany - Hong Kong - India - Israel - Italy - Japan - Malaysia - Malta - Morocco - Philippines - Singapore - Spain - Sweden - Switzerland - United Kingdom - United States of America

[www.st.com](http://www.st.com)

# Mouser Electronics

Authorized Distributor

Click to View Pricing, Inventory, Delivery & Lifecycle Information:

[STMicroelectronics:](#)

[STY112N65M5](#)