

## Description

Available in through-hole package, the T810T-8T Triac can be used for the on/off or phase angle control function in general purpose AC switching. This device can be directly driven by a microcontroller due to its 10 mA gate current requirement.

**Table 1. Device summary**

| Symbol             | Value | Unit |
|--------------------|-------|------|
| $I_{T(rms)}$       | 8     | A    |
| $V_{DRM}, V_{RRM}$ | 800   | V    |
| $V_{DSM}, V_{RSM}$ | 900   | V    |
| $I_{GT}$           | 10    | mA   |

## Features

- Medium current Triac
- Three quadrants
- ECOPACK<sup>®</sup>2 compliant component

## Applications

- General purpose AC line load switching
- Motor control circuits
- Small home appliances
- Lighting
- Inrush current limiting circuits
- Overvoltage crowbar protection

# 1 Characteristics

**Table 2. Absolute ratings (limiting values,  $T_j = 25\text{ °C}$  unless otherwise stated)**

| Symbol             | Parameter  |                          | Value                          | Unit        |
|--------------------|--|--------------------------|--------------------------------|-------------|
| $I_{T(rms)}$       | On-state rms current (full sine wave)  |                          | $T_c = 131\text{ °C}$<br>8     | A           |
| $I_{TSM}$          | Non repetitive surge peak on-state current (full cycle, $T_j$ initial = $25\text{ °C}$ )     | f = 50 Hz<br>t = 20 ms   | 60                             | A           |
|                    |  | f = 60 Hz<br>t = 16.7 ms | 63                             |             |
| $I^2t$             | $I^2t$ value for fusing, $T_j$ initial = $25\text{ °C}$                                      |                          | $t_p = 10\text{ ms}$<br>24     | $A^2s$      |
| $V_{DRM}, V_{RRM}$ | Repetitive surge peak off-state voltage  |                          | $T_j = 150\text{ °C}$<br>600   | V           |
|                    |  |                          | $T_j = 125\text{ °C}$<br>800   |             |
| $V_{DSM}, V_{RSM}$ | Non repetitive surge peak off-state voltage  |                          | $t_p = 10\text{ ms}$<br>900    | V           |
| di/dt              | Critical rate of rise of on-state current<br>$I_G = 2 \times I_{GT}, t_r \leq 100\text{ ns}$ |                          | F = 100 Hz<br>100              | A/ $\mu s$  |
| $I_{GM}$           | Peak gate current  | $t_p = 20\text{ }\mu s$  | $T_j = 150\text{ °C}$<br>4     | A           |
| $P_{G(AV)}$        | Average gate power dissipation   |                          | $T_j = 150\text{ °C}$<br>1     | W           |
| $T_{stg}$<br>$T_j$ | Storage junction temperature range<br>Operating junction temperature range                   |                          | - 40 to + 150<br>- 40 to + 150 | $^{\circ}C$ |
| $T_L$              | Maximum lead temperature for soldering during 10 s   |                          | 260                            | $^{\circ}C$ |

**Table 3. Electrical characteristics ( $T_j = 25\text{ °C}$ , unless otherwise specified)**

| Symbol                  | Test conditions  | Quadrant              |      | Value | Unit       |
|-------------------------|--|-----------------------|------|-------|------------|
| $I_{GT}$                | $V_D = 12\text{ V}, R_L = 30\text{ }\Omega$                    | I - II - III          | Min. | 0.5   | mA         |
|                         |  |                       | Max. | 10    |            |
| $V_{GT}$                | $V_D = 12\text{ V}, R_L = 30\text{ }\Omega$                    | I - II - III          | Max. | 1.3   | V          |
| $V_{GD}$                | $V_D = V_{DRM}, R_L = 3.3\text{ k}\Omega, T_j = 150\text{ °C}$ | I - II - III          | Min. | 0.2   | V          |
| $I_H^{(1)}$             | $I_T = 500\text{ mA}$  |                       | Max. | 15    | mA         |
| $I_L$                   | $I_G = 1.2 I_{GT}$   | I - III               | Max. | 20    | mA         |
|                         |  | II                    |      | 25    |            |
| dV/dt <sup>(1)</sup>    | $V_D = V_R = 536\text{ V}, \text{gate open}$                   | $T_j = 125\text{ °C}$ | Min. | 250   | V/ $\mu s$ |
|                         | $V_D = V_R = 402\text{ V}, \text{gate open}$                   | $T_j = 150\text{ °C}$ |      | 170   | V/ $\mu s$ |
| (di/dt) <sup>c(1)</sup> | (dV/dt) <sup>c</sup> = 0.1 V/ $\mu s$                          | $T_j = 125\text{ °C}$ | Min. | 6.0   | A/ms       |
|                         |  | $T_j = 150\text{ °C}$ |      | 4.2   |            |
| (di/dt) <sup>c(1)</sup> | (dV/dt) <sup>c</sup> = 10 V/ $\mu s$                           | $T_j = 125\text{ °C}$ | Min. | 3.2   | A/ms       |
|                         |  | $T_j = 150\text{ °C}$ |      | 1.4   |            |

1. For both polarities of A2 referenced to A1

Table 4. Static characteristics

| Symbol                 | Test conditions                                     |                                    |      | Value | Unit          |
|------------------------|---|------------------------------------|------|-------|---------------|
| $V_T^{(1)}$            | $I_{TM} = 11.3 \text{ A}$ , $t_p = 380 \mu\text{s}$ | $T_j = 25 \text{ }^\circ\text{C}$  | Max. | 1.55  | V             |
| $V_{i0}^{(1)}$         | Threshold voltage                                   | $T_j = 150 \text{ }^\circ\text{C}$ | Max. | 0.85  | V             |
| $R_d^{(1)}$            | Dynamic resistance                                  | $T_j = 150 \text{ }^\circ\text{C}$ | Max. | 57    | m $\Omega$    |
| $I_{DRM}$<br>$I_{RRM}$ | $V_{DRM} = V_{RRM} = 800 \text{ V}$                 | $T_j = 25 \text{ }^\circ\text{C}$  | Max. | 5     | $\mu\text{A}$ |
|                        |   | $T_j = 125 \text{ }^\circ\text{C}$ |      | 0.8   | mA            |
|                        | $V_{DRM} = V_{RRM} = 600 \text{ V}$                 | $T_j = 150 \text{ }^\circ\text{C}$ | Max. | 2.4   |               |

1. For both polarities of A2 referenced to A1

Table 5. Thermal resistance

| Symbol        | Parameter                | Value | Unit               |
|---------------|--------------------------|-------|--------------------|
| $R_{th(j-c)}$ | Junction to case (AC)    | 1.9   | $^\circ\text{C/W}$ |
| $R_{th(j-a)}$ | Junction to ambient (DC) | 60    | $^\circ\text{C/W}$ |

Figure 1. Maximum power dissipation versus on-state rms current

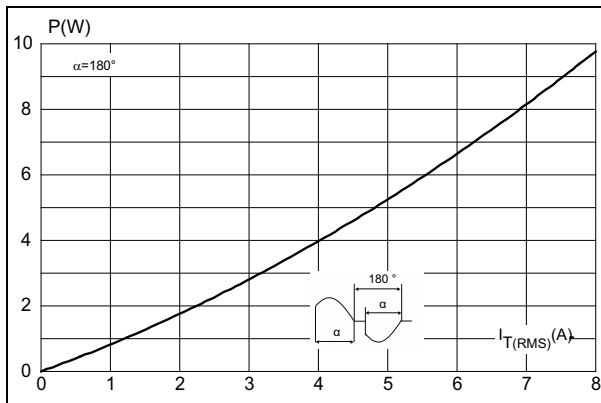

Figure 2. On-state rms current versus case temperature

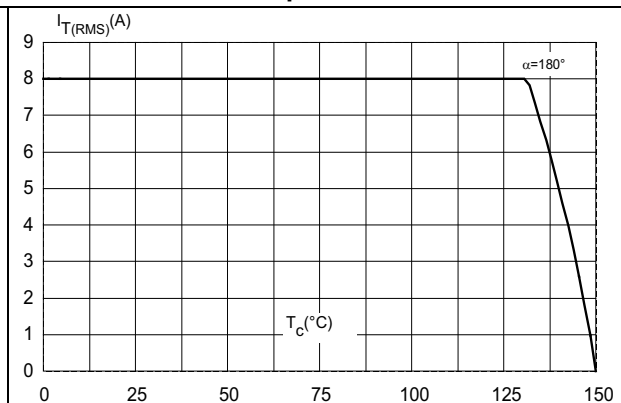

Figure 3. On-state rms current versus ambient temperature (free air convection)

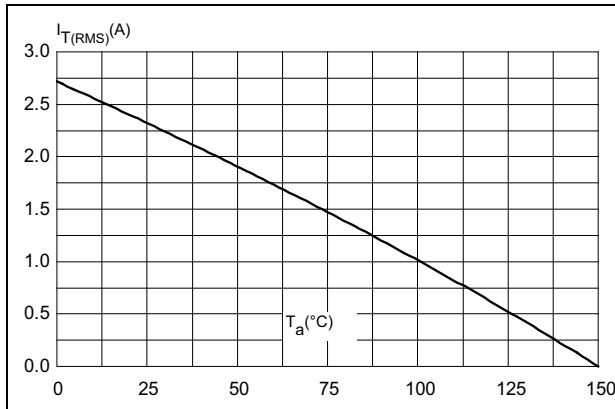

Figure 4. Relative variation of thermal impedance versus pulse duration

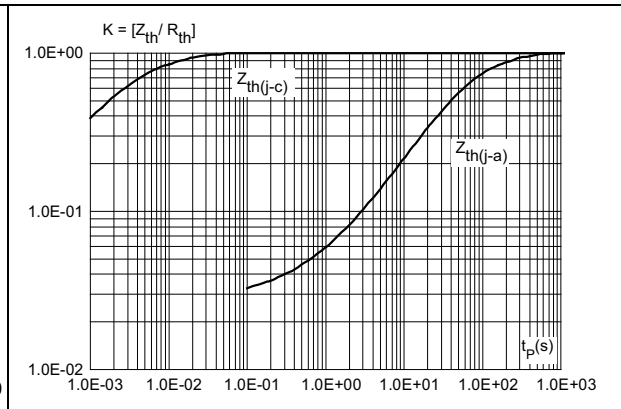

Figure 5. On-state characteristics (maximum values)

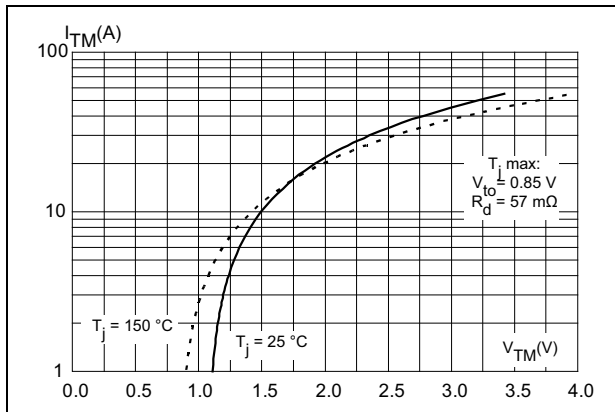

Figure 6. Surge peak on-state current versus number of cycles

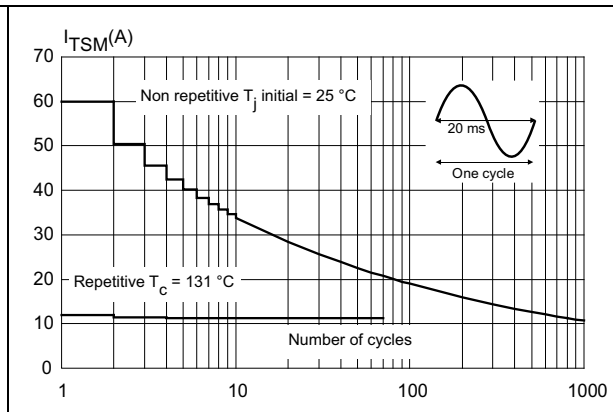

Figure 7. Non repetitive surge peak on-state current

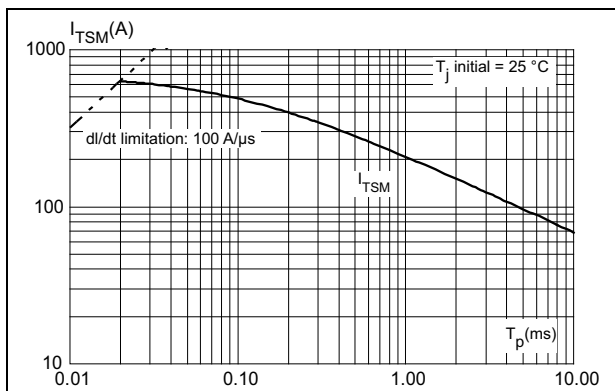

Figure 8. Relative variation of gate trigger current and gate voltage versus junction temperature (typical values)

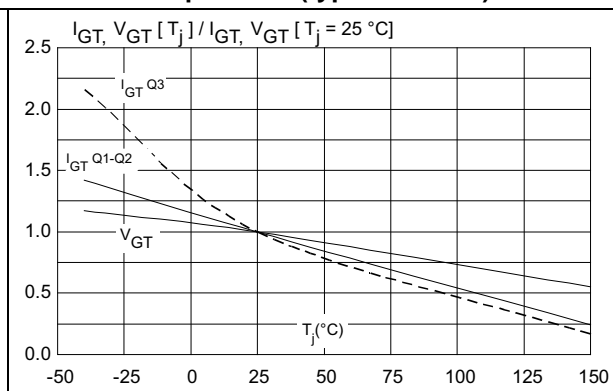

Figure 9. Relative variation of critical rate of decrease of main current versus junction temperature (typical values)

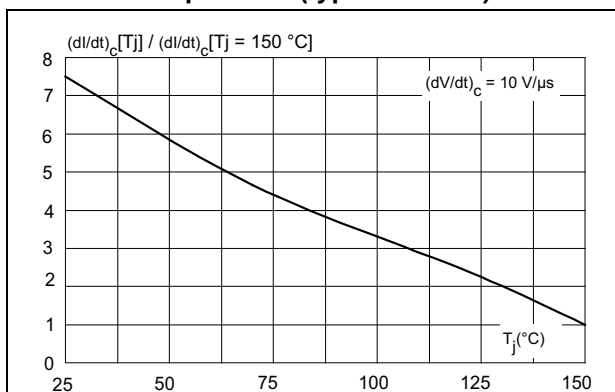
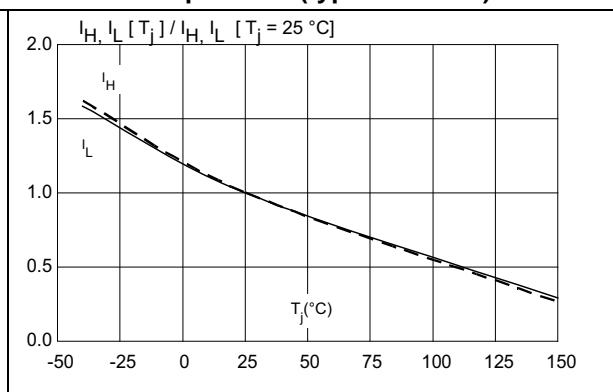
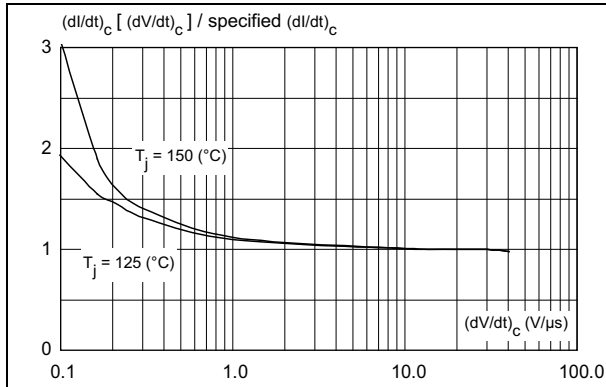

Figure 10. Relative variation of holding current and latching current versus junction temperature (typical values)



**Figure 11. Relative variation of critical rate of decrease of main current  $(di/dt)_C$  versus reapplied  $(dV/dt)_C$  (maximum values)**



**Figure 12. Relative variation of static  $dV/dt$  immunity versus junction temperature (typical values)**

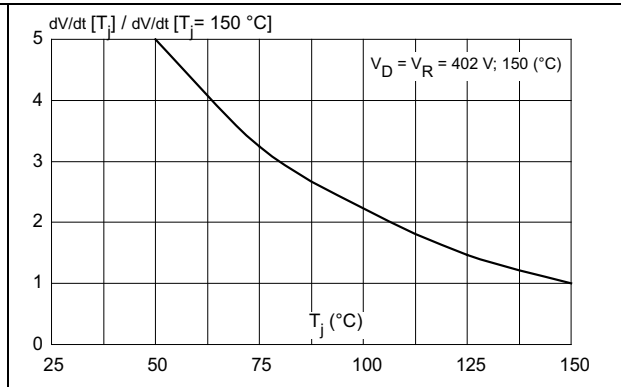

**Figure 13. Relative variation of leakage current versus junction temperature for different values of blocking voltage (typical values)**

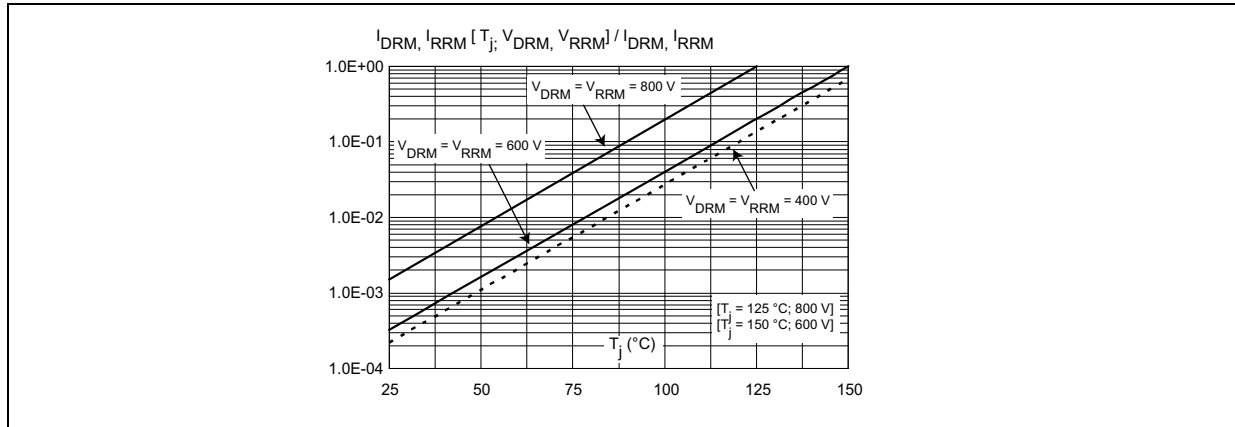

## 2 Package information

- Epoxy meets UL94, V0
- Lead-free package
- Recommended torque: 0.4 to 0.6 N·m

In order to meet environmental requirements, ST offers these devices in different grades of ECOPACK® packages, depending on their level of environmental compliance. ECOPACK® specifications, grade definitions and product status are available at: [www.st.com](http://www.st.com). ECOPACK® is an ST trademark.

Figure 14. TO-220AB dimension definitions

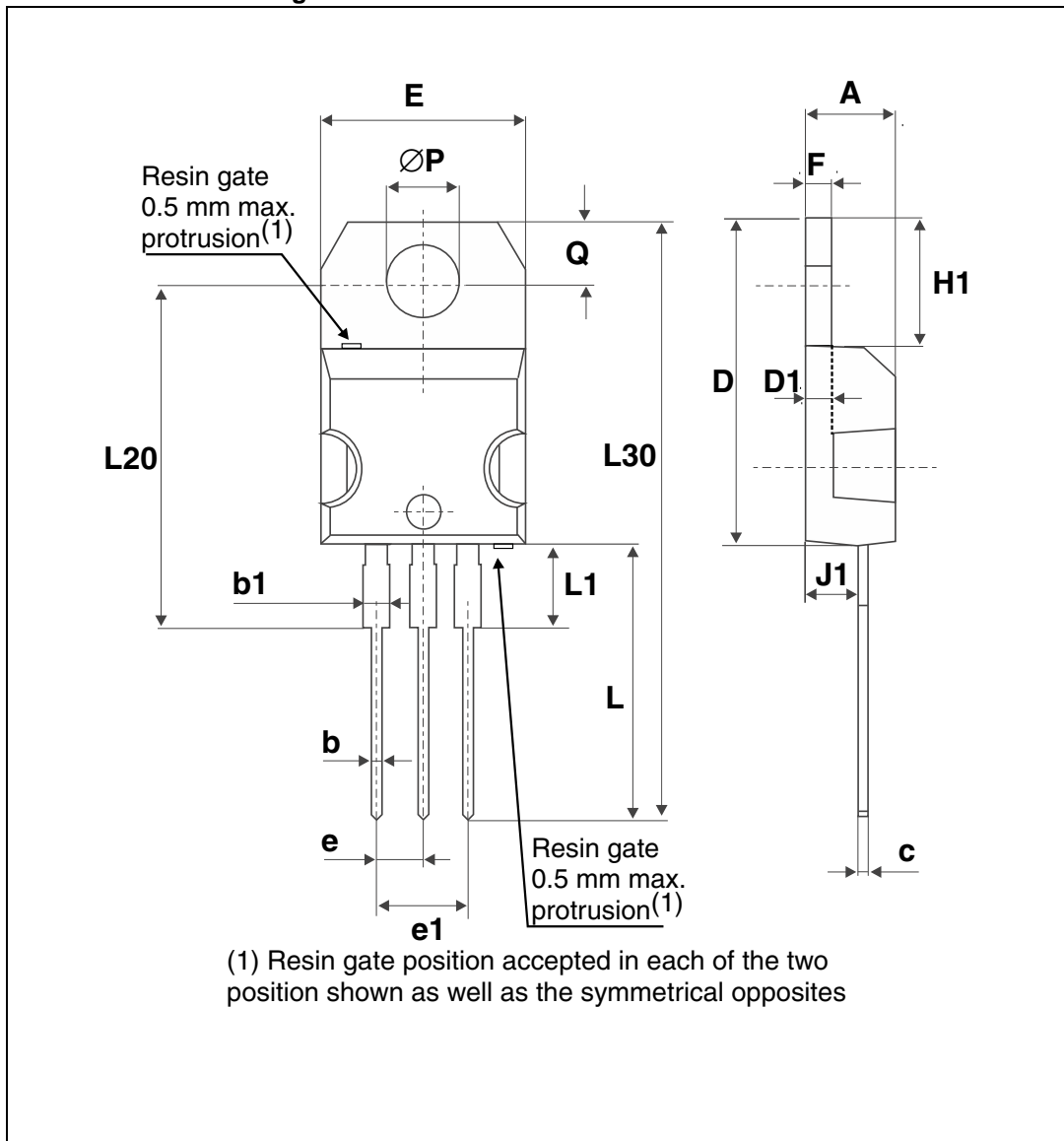

Table 6. TO-220AB dimension values

| Ref. | Dimensions  |       |           |       |
|------|-------------|-------|-----------|-------|
|      | Millimeters |       | Inches    |       |
|      | Min.        | Max.  | Min.      | Max.  |
| A    | 4.40        | 4.60  | 0.17      | 0.18  |
| b    | 0.61        | 0.88  | 0.024     | 0.035 |
| b1   | 1.14        | 1.70  | 0.045     | 0.067 |
| c    | 0.48        | 0.70  | 0.019     | 0.027 |
| D    | 15.25       | 15.75 | 0.60      | 0.62  |
| D1   | 1.27 typ.   |       | 0.05 typ. |       |
| E    | 10          | 10.40 | 0.39      | 0.41  |
| e    | 2.40        | 2.70  | 0.094     | 0.106 |
| e1   | 4.95        | 5.15  | 0.19      | 0.20  |
| F    | 1.23        | 1.32  | 0.048     | 0.052 |
| H1   | 6.20        | 6.60  | 0.24      | 0.26  |
| J1   | 2.40        | 2.72  | 0.094     | 0.107 |
| L    | 13          | 14    | 0.51      | 0.55  |
| L1   | 3.50        | 3.93  | 0.137     | 0.154 |
| L20  | 16.40 typ.  |       | 0.64 typ. |       |
| L30  | 28.90 typ.  |       | 1.13 typ. |       |
| ØP   | 3.75        | 3.85  | 0.147     | 0.151 |
| Q    | 2.65        | 2.95  | 0.104     | 0.116 |

### 3 Ordering information

Figure 15. Ordering information scheme

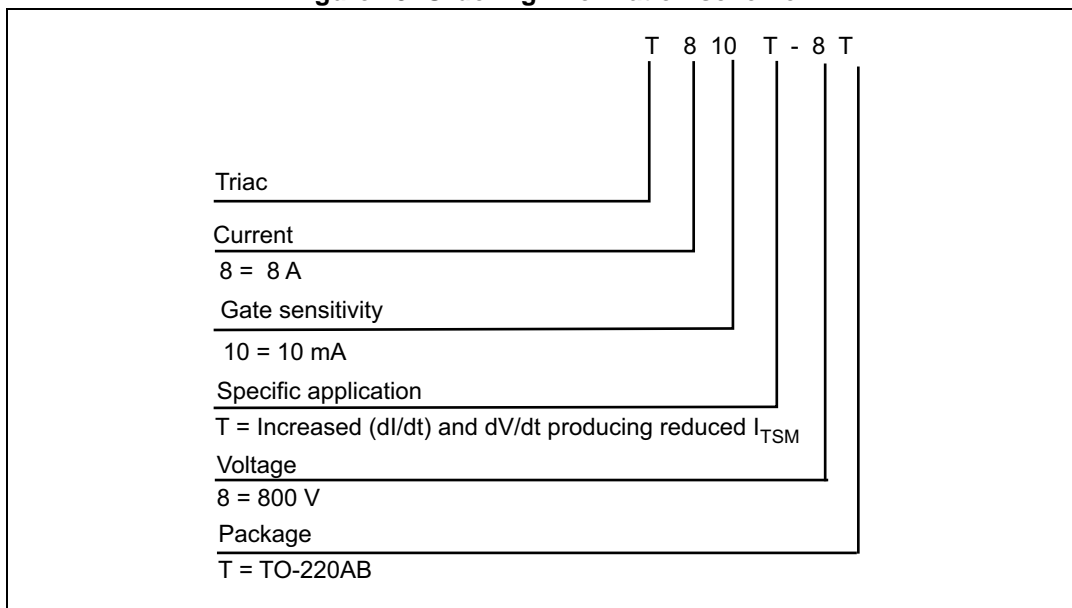

Table 7. Ordering information

| Order code | Marking  | Package  | Weight | Base qty | Delivery mode |
|------------|----------|----------|--------|----------|---------------|
| T810T-8T   | T810T-8T | TO-220AB | 2.0 g  | 50       | Tube          |

### 4 Revision history

Table 8. Document revision history

| Date        | Revision | Changes          |
|-------------|----------|------------------|
| 07-Nov-2014 | 1        | Initial release. |



**IMPORTANT NOTICE – PLEASE READ CAREFULLY**

STMicroelectronics NV and its subsidiaries ("ST") reserve the right to make changes, corrections, enhancements, modifications, and improvements to ST products and/or to this document at any time without notice. Purchasers should obtain the latest relevant information on ST products before placing orders. ST products are sold pursuant to ST's terms and conditions of sale in place at the time of order acknowledgement.

Purchasers are solely responsible for the choice, selection, and use of ST products and ST assumes no liability for application assistance or the design of Purchasers' products.

No license, express or implied, to any intellectual property right is granted by ST herein.

Resale of ST products with provisions different from the information set forth herein shall void any warranty granted by ST for such product.

ST and the ST logo are trademarks of ST. All other product or service names are the property of their respective owners.

Information in this document supersedes and replaces information previously supplied in any prior versions of this document.

© 2014 STMicroelectronics – All rights reserved

# Mouser Electronics

Authorized Distributor

Click to View Pricing, Inventory, Delivery & Lifecycle Information:

[STMicroelectronics:](#)

[T810T-8T](#)