

TOSHIBA

Leading Innovation >>>

> BLUETOOTH SILICON AND SOFTWARE FOR WIRELESS COMMUNICATION

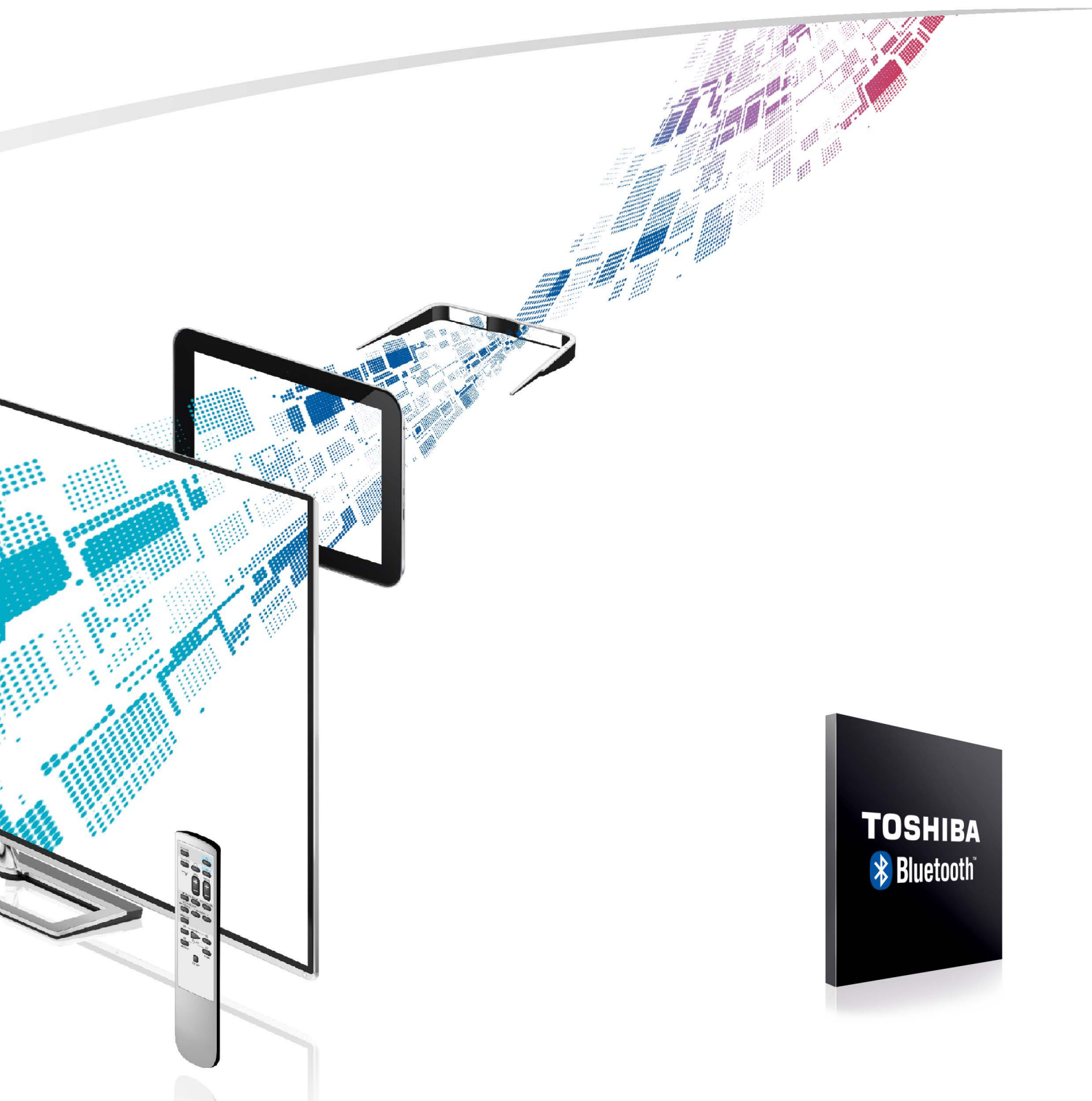

SINGLE CHIP SOLUTIONS FOR THE UTMOST FLEXIBILITY

> BLUETOOTH ICs FOR COMPACT AND ULTRA-LOW POWER DESIGNS

Toshiba offers an all-in-one solution for high quality Bluetooth® ICs with stable, reliable Bluetooth profiles. Benefitting from over 15 years' experience, Toshiba's Bluetooth ICs offer low power solutions with both Bluetooth Classic and Low Energy line-ups of firmware. Toshiba's devices realise an easy way to integrate Bluetooth for various industrial, medical, smart home, wearable and automotive applications.

All Toshiba Bluetooth devices and embedded software are Bluetooth Qualification Expert (BQE) qualified.

The next generation of devices will also support the new Bluetooth 4.2 standard.

- Embedded Bluetooth stack and selected profiles
- Proven interoperability
- Suitable for a variety of application scenarios
- High-quality, cost-effective Bluetooth-compliant designs
- Low power consumption

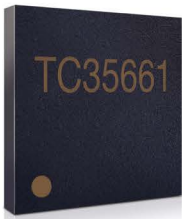

> TC35661

The TC35661 is dual mode, it supports both the Bluetooth Classic (3.0 + EDR) and the new BT Low Energy (LE) 4.0 standard. TC35661SBG supports the standard Bluetooth HCI interface and offers integration of stack and selected BT profiles on-chip as well. The device offers simple Bluetooth integration for various industrial, medical, smart home, wearable and automotive applications. The device is also automotive qualified (AECQ100).



> TC35667 / TC35676

The TC35667 and TC35676 are highly integrated RFCMOS Bluetooth devices that support the BT Low Energy (LE) 4.1 standard. Both devices are suitable for ultra low power portable products. The devices come with an embedded BLE stack and GATT profile. An over-the-air (OTA) software update service can be realized. Both devices can be used with a host or in a standalone configuration. TC35676 also includes embedded Flash Memory to remove the need for external EEPROM memory in standalone mode.



> TC35670 / TC35675

The TC35670 and TC35675 Bluetooth NFC Combo devices support the BT Low Energy (LE) 4.1 standard and include an NFC Forum compliant Tag Class 3. Easy Bluetooth pairing through NFC and connection setup enables ease of use at very low power. An active NFC device may switch on the Bluetooth LSIs with zero battery power use. The devices are ideal for ultra low power portable products and come with embedded BLE stack and GATT profile. An over-the-air (OTA) software update service can be realized. Both devices can be used with a host or in a standalone configuration. The TC35675 also includes embedded Flash Memory to remove the need for external EEPROM memory in standalone mode.



➤ TC35670 / TC35675 SINGLE CHIP CONTROLLER FOR BLUETOOTH LE (4.1) + NFC TAG



The NFC Tag built into the TC35670 and TC35675 can wake up the BLE devices from sleep mode through the NFC antenna and initiate easy Bluetooth pairing after confirmation of the BT device address. This connection setup enables ease of use and a very long battery life. TC35670 and TC35675 are ideal for ultra low power portable products and come with embedded BLE stack and GATT profiles.

➤ KEY BENEFITS

- Allows the extension of battery lifetimes by supporting wake up with 0 standby current. The integration of an NFC Tag and Bluetooth LSI allows the Bluetooth circuit to be off until woken up by an active NFC controller signal from another device.
- Easy pairing initialization or safe out-of-band pairing, and transfer of small amounts of data with NFC Forum compliant Tag
- Exchange of data with NFC Tag EEPROM without waking up the Bluetooth circuit
- Flexible system architectures through:
 - Embedded Bluetooth profile model (API over host UART)
 - Stand alone model (with embedded Bluetooth stack and profile, no host needed)
- Bluetooth qualified embedded BLE stack and GATT profile for easy Bluetooth product qualification
- Ultra-low bill of materials due to very few external components:
 - With TC35675 no external EEPROM memory is needed due to on-chip Flash
 - System integration is simplified by various on-chip peripherals
 - Only a small RF circuit is necessary due to built-in discrete components
- An over-the-air (OTA) software update service can be realized
- The device can operate at voltages between 1.8V and 3.6V making it suitable for use with various battery types such as coin cell, AAA or AA
- Various sleep modes and clock options to optimize power consumption
- QFN40/FBGA52 package allows small form factor designs

➤ FEATURES

- Bluetooth Low Energy (BLE) 4.1 compliant
- Supports BLE GAP central and peripheral mode
- Internal RAM for application code, data patches
- TC35675: Embedded 192KB Flash Memory
- Wake up signal from NFC tag for Bluetooth host device
- Tag communication: NFC Type 3 Tag (ISO/IEC18092)
- Tag communication speed: 212kbps / 424kbps automatic switchover
- On-chip 2KB EEPROM accessible from Bluetooth controller or NFC antenna
- Tag Security: Mutual recognition by Triple DES MAC (MAC: Message Authentication Code)
- On-chip balun, antenna switch, LNA, DC-DC converter
- Operational Voltage: 1.8V to 3.6V
- BLE peak power consumption: 5.9mA (depends on selected clocking scheme and data mode)
- Deep sleep mode: 0.1µA; sleep mode 5µA
- Peak current in operation mode: 5.9mA
- Tag Operational Mode: 600µA
- Transmitter Output Power: 0dBm to -20dBm (4dB steps)
- RX Sensitivity: -92.5dBm (typ.)
- Operating Temperature Range: -30°C to 80°C
- TC35670 Package: 40pin QFN 6mm x 6mm x 0.5mm pitch, 0.9mm height
- TC35675 Package: 52pin FBGA 4.5mm x 4.5mm, 0.5mm pitch, 1.2mm height
- Profiles: GATT (Generic Attribute Profile), including server and client functions
- Interfaces: UART (2), SPI & I2C interface, PWM output (3channels), ADC (4 channels), 7 programmable IO

➤ BLOCK DIAGRAM

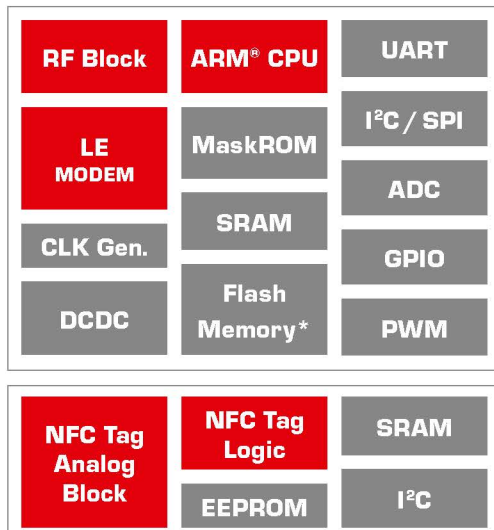

*TC35675 Only

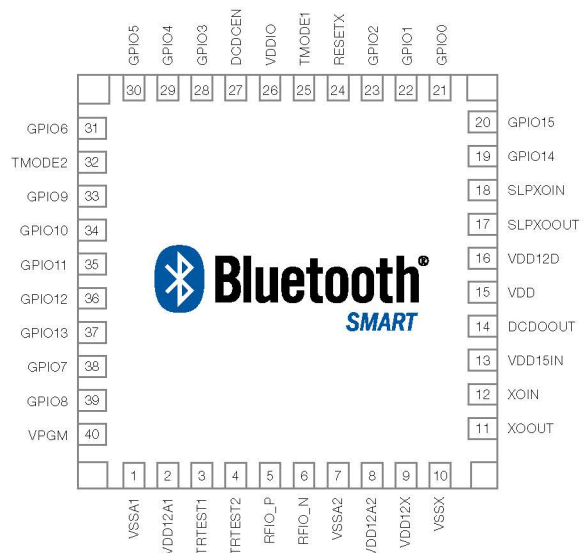

TC35670 Example

> TC35661

SINGLE CHIP CONTROLLER FOR BLUETOOTH CLASSIC (3.0 + EDR) AND BLUETOOTH LE (4.0)



The device realises an easy way to integrate Bluetooth for various industrial, medical, wearable and automotive applications.

> KEY BENEFITS

- Dual Mode core for classic and new Bluetooth 4.0 standard
- BQE qualified hardware and software for easy Bluetooth EPL
- Flexible system architectures through:
 - HCI model
 - Embedded stack and profile model
 - Standalone model (with embedded stack and profile)
- Embedded on-chip Bluetooth stack and selected profiles for easy Bluetooth system design
- Stand alone operation with embedded SPP or HID profile for small applications is feasible without a host MCU
- Ultra low bill of materials due to very few external components
- Multiple programmable IO and peripheral options
- On-chip voltage controller and low power modes
- Consumer and automotive qualification (AEC-Q100)

System	System Configuration	Product ID (*)
BT 4.0 HCI standard	HCI	TC35661-007
BT 4.0 HCI standard & WideBand speech	HCI	TC35661-008
BT 4.0 Embedded Profile	SPP (with EDR)	TC35661-203
	SPP+BLE GATT	TC35661-501/502
	HID+BLE GATT	TC35661-600
	SPP+HSP(AG)	TC35661-800
BT 4.0 Standalone With Embedded Profile	SPP Stand Alone	TC35661-700
	HID Stand Alone	TC35661-102
TC35661-203		

(*) Subject to firmware updates. Subject to change without notice

> FEATURES

- Bluetooth Core Spec 3.0 and 4.0, EDR and LE support
- TC35661-00X: HCI type
- TC35661-XXX: embedded profile type
- BT Class 2 support
- RX Sensitivity -91dBm (typ.)
- Baseband with ARM® CPU - 13 to 52 MHz
- On-chip ROM, RAM, including Patch-RAM
- On-chip balun, antenna switch, LNA, LDO
- Interfaces: UART, SPI, USB2.0(FS), I2C, I2S/PCM, GPIO
- Data transfer up to 2 Mbps (DH5 packets) net
- Package: 64ball BGA (ROM version), 0.5/0.8mm pitch, 1.2/1.4mm height
- Operational voltage: 1.8V or 3.3V (typ.)
- Low power sleep mode 30uA (max)
- Operation current well below 30mA (depends on packet type and selected operational mode)
- AEC-Q100 automotive qualification (0.8mm pitch)

> TC35661SBG (FBGA64)

UART	ARM® CPU 13-52 MHZ	RF BLOCK Class 2
USB 2.0		EDR / LE Modem
I²C, I²S SPI	ROM	
GPIO	SRAM	



> HCI SYSTEM CONCEPT

The Bluetooth HCI (host controller interface) model: the low layer stack (RF, LC, LM) runs on the TC35661 device for both Bluetooth Classic and BLE (4.0). Through a UART or USB it is connected to an external host processor, which executes the upper Bluetooth stack (L2CAP, RFCOMM) and profiles. Beyond the upper stack the host processor runs the application software. This application processor may also run additional tasks such as middleware and multimedia functions. This concept is suitable for voice and data. It can be combined with third-party Bluetooth protocol stacks over the standardized HCI software interface.

> TC35661-00X

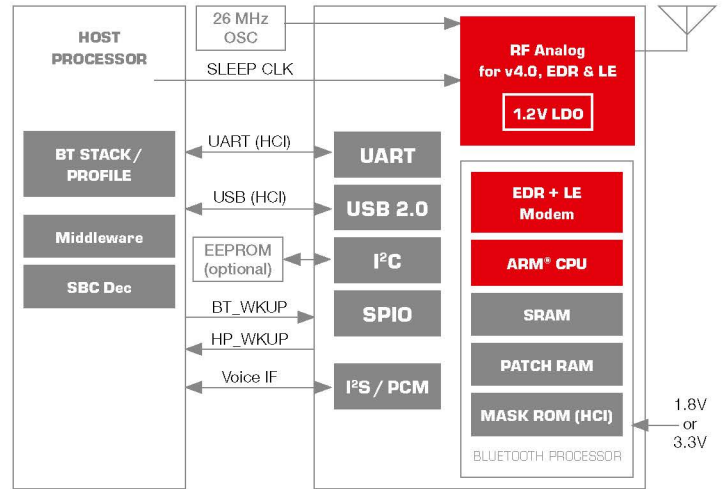

> EMBEDDED PROFILE SYSTEM CONCEPT

The embedded profile model integrates both the lower and upper stack as well as some selected profiles in the TC35661. The UART interface carries control and payload data to/from the embedded API. The entire Bluetooth functionality is managed by the Bluetooth LSI. The host processor handles the application data and some basic system control. Depending on the complexity of the application, the host CPU performance requirement is very minor. This concept is for data only. The embedded profile models for BT4.0 feature Smart Ready (dual mode) or Smart (BLE single mode) Bluetooth marking. Toshiba offers source code for an optional high level host driver fitting to the embedded API in order to simplify design to enable fast time to market.

> TC35661-XXX

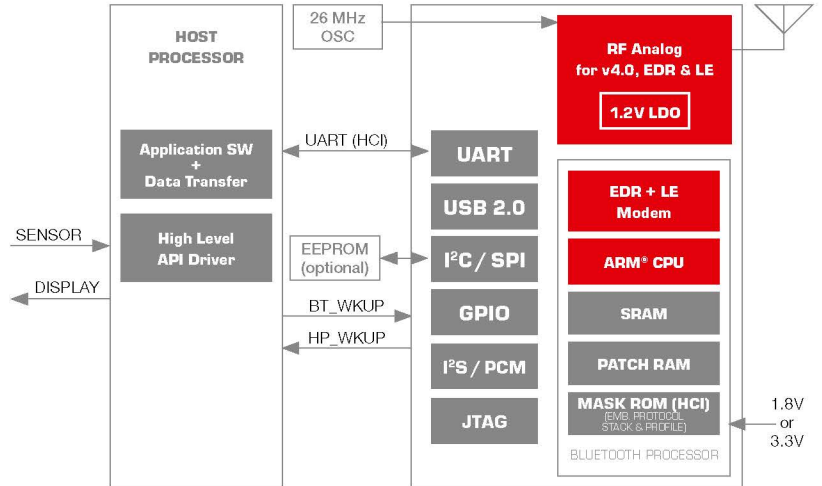

> STANDALONE SYSTEM CONCEPT

Stand alone operation with embedded SPP or HID profile for small applications is feasible without a host MCU.

> TC35661 EMBEDDED PROFILE SOFTWARE MODELS

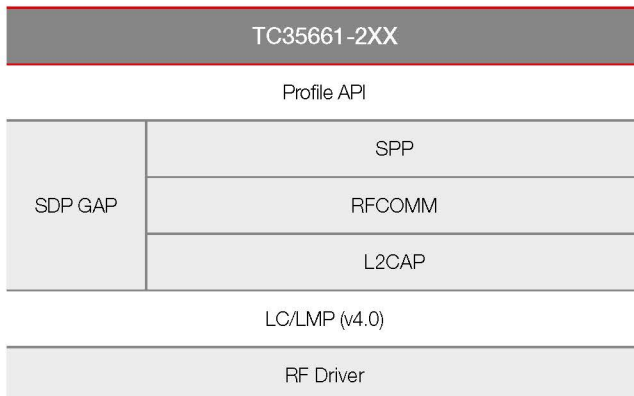

with Serial Port Profile (SPP) for wireless cable replacement

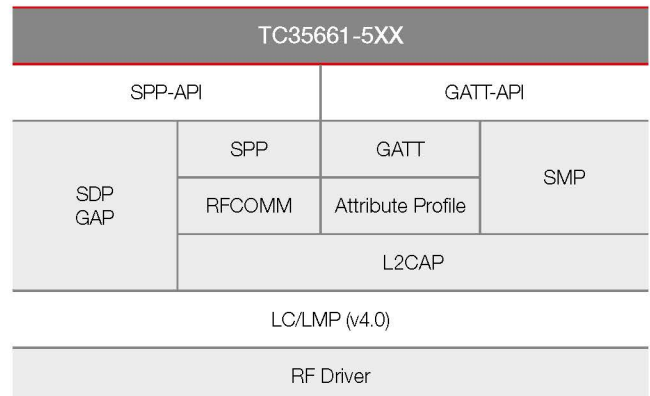

with GATT and SPP profile for BT 4.0 dual mode enabled accessory products

➤ TC35667 / TC35676 SINGLE CHIP CONTROLLERS FOR BLUETOOTH LE (4.1)

TC35667 and TC35676 are suitable for ultra low power portable products. The devices come with embedded BLE stack and GATT profiles. Toshiba has tested the Bluetooth interoperability extensively and performed Bluetooth Qualification Expert (BQE) qualification.



➤ KEY BENEFITS

- Flexible system architectures through:
 - Embedded Bluetooth profile model (API over host UART)
 - Stand alone model (with embedded Bluetooth stack and profile, no host needed)
- Bluetooth qualified embedded BLE stack and GATT profile for easy Bluetooth product qualification
- Ultra-low bill of materials due to very few external components:
 - With TC35676 no external EEPROM memory is needed due to on-chip Flash
 - System integration is simplified by various on-chip peripherals
 - Only a small RF circuit is necessary due to built-in discrete components
- An over-the-air (OTA) software update service can be realized
- The device can operate at voltages between 1.8V and 3.6V making it suitable for use with various battery types such as coin cell, AAA, or AA
- Various sleep modes and clock options to optimize power consumption
- QFN40 package and CSP41 (for TC35667) allows small and cheap form factor designs.

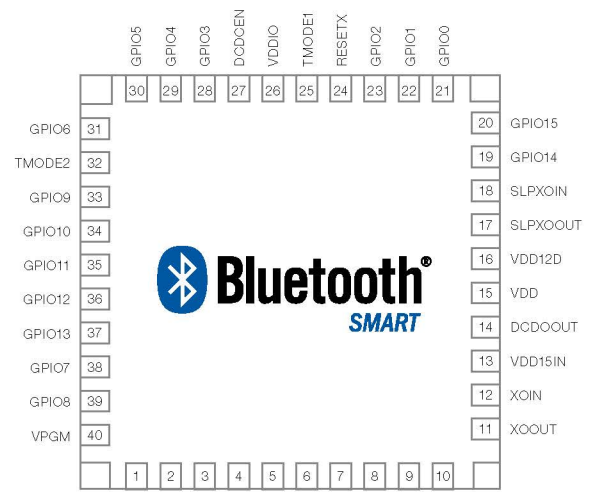

TC35667 Example

➤ FEATURES

- Bluetooth Low Energy (BLE) 4.1 compliant
- Supports BLE GAP central and peripheral mode
- Internal RAM for application code, data patches
- TC35676; Embedded 192KB Flash Memory
- On-chip balun, antenna switch, LNA, DC-DC converter
- Operational Voltage: 1.8V to 3.6V
- BLE peak power consumption: 5.9mA (depends on selected clocking scheme and data mode)
- Deep sleep mode: 0.1µA; sleep mode 5µA
- Peak current in operation mode: 5.9mA
- Transmitter Output Power: 0dBm to -20dBm (4dB steps)
- RX Sensitivity: -92.5dBm (typ.)
- Operating Temperature Range: -40°C to 85°C
- Package: 40pin QFN 6mm x 6mm 0.5mm ball pitch or 5mm x 5mm 0.4mm ball pitch, height 0.9mm, or CSP41 3mm x 3mm
- Profiles: GATT (Generic Attribute Profile), including server and client functions
- Interfaces: UART (2), SPI & I2C interface, PWM output (3channels), ADC (4 channels), 15 programmable IO

➤ STANDALONE APPLICATION EXAMPLE

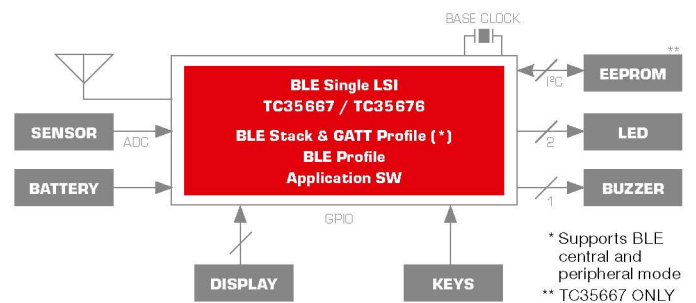

➤ BLOCK DIAGRAM

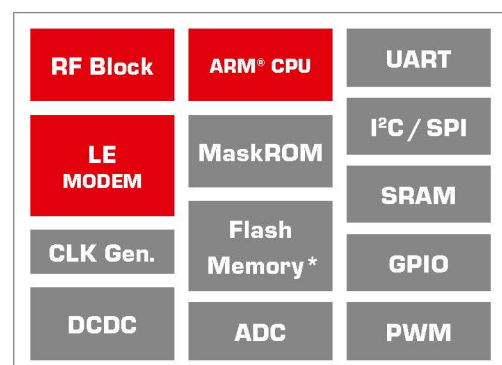

*TC35676 Only

➤ BLUETOOTH HARDWARE DEVELOPMENT TOOLS

Toshiba's starter kits allow designers to develop and test their own Bluetooth software and application designs.

➤ BLUETOOTH LE STARTER KIT FOR TC35667

The BMSKTOPAS Bluetooth starter kit series enables quick and easy use of Toshiba's Bluetooth LE LSIs (integrated in the mounted PAN1760 module) in combination with Toshiba's CortexM3 MCU as a host MCU. The kit can be used with commercial software development tools (e.g. IAR tool chain) over a JTAG debugger to simplify system software creation. It is made to execute the Toshiba Bluetooth SDK driver software and run & debug user application code via the embedded J-Link debugger interface. The TMPM369FDG Microcontroller offers embedded flash and SRAM for evaluation and debugging purposes as well as embedded Ethernet, CAN, USB host, USB device and RS-232 connectivity.

The Bluetooth SDK is available from <https://apps.toshiba.de/web/SDKRegistration/>

Starter Kit Contents:

- Toshiba BMSKTOPASM369xxx
- Plug-on NFC antenna (only for BLE/NFC starter kit)
- Segger J-Link JTAG/SWD emulator with USB interface
- J-Link 19-pin Cortex-M adapter
- USB cable
- Rapid start-up guide

Kit Models:

- BMSKTOPASM369BT(kc) for TC35661-501 Dual Mode LSI
- BMSKTOPASM369BLE(kc) for TC35667 BLE Single LSI
- BMSKTOPASM369BT1761(kc) for TC35670 BLE / NFC Combo LSI
- Starter kits for TC35676 and TC35675 are under development



➤ BLUETOOTH LE STANDALONE DEVELOPMENT KIT FOR TC35667

The BLESADevBoard667BT(sch) stand alone development kit enables development and debugging of true stand-alone applications. It works without an external host MCU. The kit can be used with commercial software development tools (e.g. IAR tool chain) over a JTAG debugger for easy development. The embedded TC35667 BLE device executes both application, protocol stack and selected profiles. The various on-chip I/O of the device are available on the kit's connectors. The kit is made to develop, debug and run the system application code via the embedded J-Link debugger interface. Toshiba offers a software tool to map and program the debugged code into the on-chip Flash memory or the external EEPROM (connected to TC35667 via I2C) of the final application system.

The Bluetooth SDK is available from <https://apps.toshiba.de/web/SDKRegistration/>

Starter Kit Contents:

- Toshiba BLESADevBoard667BT board
- Segger J-Link JTAG/SWD emulator with USB interface
- USB cable
- Rapid start-up guide

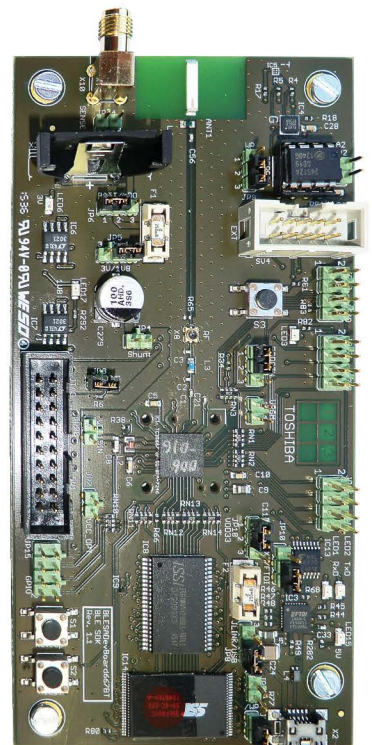

> BLUETOOTH SOFTWARE SUPPORT

Toshiba offers a Bluetooth SDK with Bluetooth Classic and LE driver software source code (C++). The SDK is free of charge for use with Toshiba Bluetooth LSIs. The software can be ported onto any external host processor (linked to the Bluetooth LSI via UART) or used for stand-alone (no host) designs, if the chip firmware supports it.

The software simplifies Bluetooth software development via an abstracted high level API. It allows for fast turn-around times for system integration. It is available for dual mode (SPP & BLE) and single mode (BLE single) devices. It includes various PTS tested BLE profiles as references as well as a Toshiba SPPoverBLE profile. The SDK shows how a software engineer may create their own BLE profiles using reference examples and related instructions. Toshiba will also launch a plug-in for the Bluetooth SIG developer Studio. It can be ported to system host controllers or used for a standalone solution. The SDK can be used with or without RTOS. It is hardware platform independent (LSI, Module, Starterkit, Development Kits, Beacons etc.). Android client reference apps are available, too.

To support the embedded NFC function, the SDK also includes the software interface to control and exchange data with the embedded NFC tag in different modes.

The SDK is available on the Toshiba Download and Developer Support site. The registration process requires log in and acceptance of the SLA (software license agreement).

Registration is possible here:
<https://apps.toshiba.de/web/SDKRegistration/>

> DUAL/ SINGLE MODE SDK

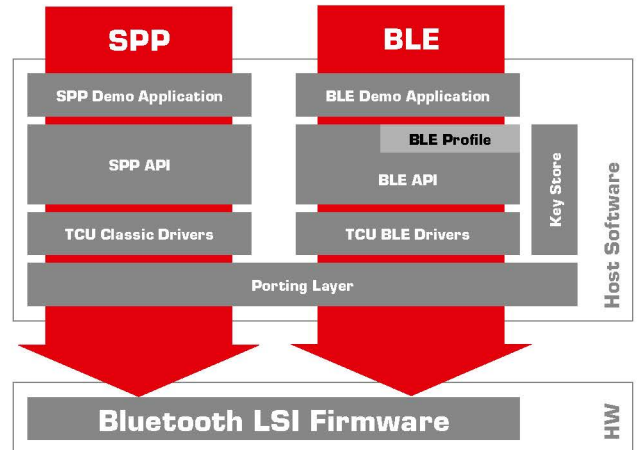

> SYSTEM SOLUTIONS

Toshiba offers complete form factor solutions including hardware, software and bill of materials details for easy re-use, modification or direct implementation into customer designs.

> SCATTERNET LIGHTING SYSTEM WITH TC35670

- Scatternet Bluetooth LE solution for lighting systems
- Multiple master (scanning) and multiple slave (advertising) configuration
- Access by multiple controllers possible
- Node set up via embedded NFC interface
- Embedded into standalone Bluetooth LE devices



> BLUETOOTH LE SCATTERNET CONCEPT

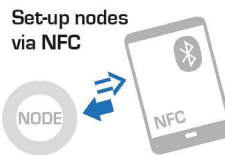
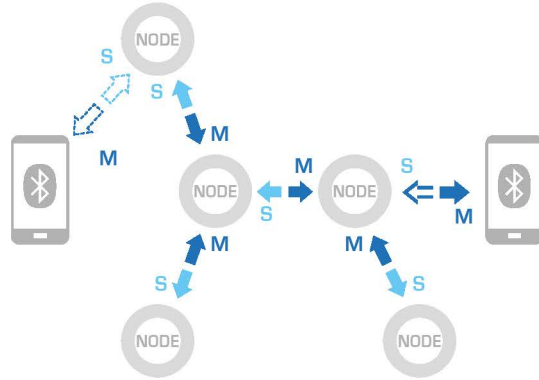

Bluetooth Smart[®]

Slave (S) \updownarrow advertising
Master (M) \updownarrow scanning

> BLUETOOTH LE & NFC TAG REFERENCE MODEL WITH TC35670

- Standalone solution
- Built-in EEPROM for Application Code (512kbit)
- Built-in multi sensors
- BLE chip antenna & NFC antenna
- Coin battery (CR2032/2025)
- Case size: Ø 30mm
- PCB size: Ø25mm, 4 layers
- Standalone application codes available
- Android client application available
- Coin battery (CR2032) power supply
- Case size: 75mm x 35mm x 12mm
- Various standalone application codes available



> BEACON REFERENCE MODEL WITH TC35670

- Standalone solution
- Built-in EEPROM for Application Code (512Kbit)
- Built-in 6-axis sensor
- Antenna for Bluetooth and NFC Tag
- Coin battery (CR2032) power supply
- Case size: 75mm x 35mm x 12mm
- Various standalone application codes available

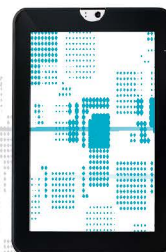
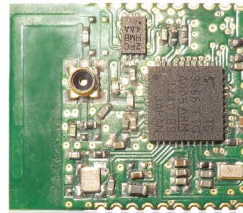

TOSHIBA
Leading Innovation >>>

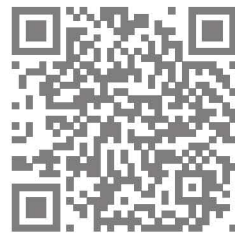

Toshiba Electronics Europe GmbH
Hansaallee 181
40549 Düsseldorf
Germany

Tel: +49 (0) 211 5296-0
Fax: +49 (0) 211 5296-470

For further information on Toshiba semiconductor products and solutions
and local sales information, please visit:

www.toshiba.semicon-storage.com/eu/wireless



The Bluetooth® word mark and logos are registered trademarks owned by Bluetooth SIG, Inc.

NFC Forum and the NFC Forum logo are trademarks of the Near Field Communication Forum.

ARM® is a registered trademark of ARM Limited (or its subsidiaries) in the EU and/or elsewhere.

Windows is a registered trademark of Microsoft Corporation in the United States and other countries.

Android is a trademark of Google Inc.

Copyright 2016 TOSHIBA Corporation. Product specifications are all subject to change without notice.
Product design specifications and colours are subject to change without notice and may vary from those shown.
Errors and omissions excepted.

Mouser Electronics

Authorized Distributor

Click to View Pricing, Inventory, Delivery & Lifecycle Information:

Toshiba:

[TC35676FSG-001\(EL\)](#) [TC35667FSG-006\(EL\)](#) [TC35667FTG-005\(EL\)](#) [TC35675XBG-001\(EL\)](#)