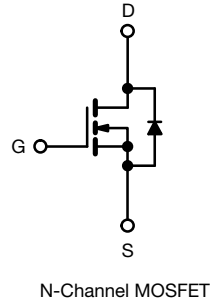
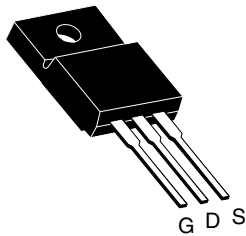

E Series Power MOSFET

PRODUCT SUMMARY	
V_{DS} (V) at T_J max.	650
$R_{DS(on)}$ max. at 25 °C (Ω)	$V_{GS} = 10$ V 0.125
Q_g max. (nC)	130
Q_{gs} (nC)	15
Q_{gd} (nC)	39
Configuration	Single

TO-220 FULLPAK

FEATURES

- Low figure-of-merit (FOM) $R_{on} \times Q_g$
- Low input capacitance (C_{iss})
- Reduced switching and conduction losses
- Ultra low gate charge (Q_g)
- Avalanche energy rated (UIS)
- Material categorization: for definitions of compliance please see www.vishay.com/doc?99912



RoHS
COMPLIANT
HALOGEN
FREE
Available

APPLICATIONS

- Server and telecom power supplies
- Switch mode power supplies (SMPS)
- Power factor correction power supplies (PFC)
- Lighting
 - High-intensity discharge (HID)
 - Fluorescent ballast lighting
 - LED lighting
- Industrial
 - Welding
 - Induction heating
 - Motor drives
- Battery chargers
- Renewable energy
 - Solar (PV inverters)

ORDERING INFORMATION	
Package	TO-220 FULLPAK
Lead (Pb)-free and Halogen-free	SiHF30N60E-GE3
Lead (Pb)-free	SiHF30N60E-E3

ABSOLUTE MAXIMUM RATINGS ($T_C = 25$ °C, unless otherwise noted)				
PARAMETER	SYMBOL	LIMIT	UNIT	
Drain-Source Voltage	V_{DS}	600	V	
Gate-Source Voltage	V_{GS}	± 30		
Continuous Drain Current ($T_J = 150$ °C) ^d	V_{GS} at 10 V	$T_C = 25$ °C	29	A
		$T_C = 100$ °C	18	
Pulsed Drain Current ^a	I_{DM}	76		
Linear Derating Factor		0.29	W/°C	
Single Pulse Avalanche Energy ^b	E_{AS}	690	mJ	
Maximum Power Dissipation	P_D	37	W	
Operating Junction and Storage Temperature Range	T_J, T_{stg}	-55 to +150	°C	
Drain-Source Voltage Slope	dV/dt	$V_{DS} = 0$ V to 80 % V_{DS}	70	V/ns
Reverse Diode dV/dt ^e		18		
Soldering Recommendations (Peak temperature) ^c	for 10 s	300	°C	
Mounting Torque	M3 screw	0.6	Nm	

Notes

- Repetitive rating; pulse width limited by maximum junction temperature.
- $V_{DD} = 50$ V, starting $T_J = 25$ °C, $L = 28.2$ mH, $R_g = 25$ Ω , $I_{AS} = 7$ A.
- 1.6 mm from case.
- Limited by maximum junction temperature.
- $I_{SD} \leq I_D$, $dI/dt = 100$ A/ μ s, starting $T_J = 25$ °C.



THERMAL RESISTANCE RATINGS				
PARAMETER	SYMBOL	TYP.	MAX.	UNIT
Maximum Junction-to-Ambient	R_{thJA}	-	65	°C/W
Maximum Junction-to-Case (Drain)	R_{thJC}	-	3.4	

SPECIFICATIONS ($T_J = 25\text{ }^\circ\text{C}$, unless otherwise noted)							
PARAMETER	SYMBOL	TEST CONDITIONS		MIN.	TYP.	MAX.	UNIT
Static							
Drain-Source Breakdown Voltage	V_{DS}	$V_{GS} = 0\text{ V}, I_D = 250\text{ }\mu\text{A}$		600	-	-	V
V_{DS} Temperature Coefficient	$\Delta V_{DS}/T_J$	Reference to $25\text{ }^\circ\text{C}, I_D = 250\text{ }\mu\text{A}$		-	0.64	-	V/°C
Gate-Source Threshold Voltage (N)	$V_{GS(th)}$	$V_{DS} = V_{GS}, I_D = 250\text{ }\mu\text{A}$		2.0	2.8	4.0	V
Gate-Source Leakage	I_{GSS}	$V_{GS} = \pm 20\text{ V}$		-	-	± 100	nA
		$V_{GS} = \pm 30\text{ V}$		-	-	± 1	μA
Zero Gate Voltage Drain Current	I_{DSS}	$V_{DS} = 600\text{ V}, V_{GS} = 0\text{ V}$		-	-	1	μA
		$V_{DS} = 600\text{ V}, V_{GS} = 0\text{ V}, T_J = 150\text{ }^\circ\text{C}$		-	-	100	
Drain-Source On-State Resistance	$R_{DS(on)}$	$V_{GS} = 10\text{ V}$	$I_D = 15\text{ A}$	-	0.104	0.125	Ω
Forward Transconductance ^a	g_{fs}	$V_{DS} = 8\text{ V}, I_D = 3\text{ A}$		-	5.4	-	S
Dynamic							
Input Capacitance	C_{iss}	$V_{GS} = 0\text{ V}, V_{DS} = 100\text{ V}, f = 1.0\text{ MHz}$		-	2600	-	pF
Output Capacitance	C_{oss}			-	138	-	
Reverse Transfer Capacitance	C_{rss}			-	3	-	
Effective Output Capacitance, Energy Related ^a	$C_{o(er)}$	$V_{DS} = 0\text{ V to } 480\text{ V}, V_{GS} = 0\text{ V}$		-	98	-	pF
Effective Output Capacitance, Time Related ^b	$C_{o(tr)}$			-	346	-	
Total Gate Charge	Q_g	$V_{GS} = 10\text{ V}$	$I_D = 15\text{ A}, V_{DS} = 480\text{ V}$	-	85	130	nC
Gate-Source Charge	Q_{gs}			-	15	-	
Gate-Drain Charge	Q_{gd}			-	39	-	
Turn-On Delay Time	$t_{d(on)}$	$V_{DD} = 380\text{ V}, I_D = 15\text{ A}, V_{GS} = 10\text{ V}, R_g = 4.7\text{ }\Omega$		-	19	40	ns
Rise Time	t_r			-	32	65	
Turn-Off Delay Time	$t_{d(off)}$			-	63	95	
Fall Time	t_f			-	36	75	
Gate Input Resistance	R_g			$f = 1\text{ MHz}, \text{open drain}$		-	
Drain-Source Body Diode Characteristics							
Continuous Source-Drain Diode Current	I_S	MOSFET symbol showing the integral reverse p - n junction diode 		-	-	29	A
Pulsed Diode Forward Current	I_{SM}			-	-	65	
Diode Forward Voltage	V_{SD}	$T_J = 25\text{ }^\circ\text{C}, I_S = 15\text{ A}, V_{GS} = 0\text{ V}$		-	-	1.3	V
Body Diode Reverse Recovery Time	t_{rr}	$T_J = 25\text{ }^\circ\text{C}, I_F = I_S = 15\text{ A}, di/dt = 100\text{ A}/\mu\text{s}, V_R = 20\text{ V}$		-	402	605	ns
Body Diode Reverse Recovery Charge	Q_{rr}			-	7	15	μC
Reverse Recovery Current	I_{RRM}			-	32	65	A

Notes

- a. $C_{oss(er)}$ is a fixed capacitance that gives the same energy as C_{oss} while V_{DS} is rising from 0 % to 80 % V_{DSS} .
- b. $C_{oss(tr)}$ is a fixed capacitance that gives the same charging time as C_{oss} while V_{DS} is rising from 0 % to 80 % V_{DSS} .

TYPICAL CHARACTERISTICS (25 °C, unless otherwise noted)

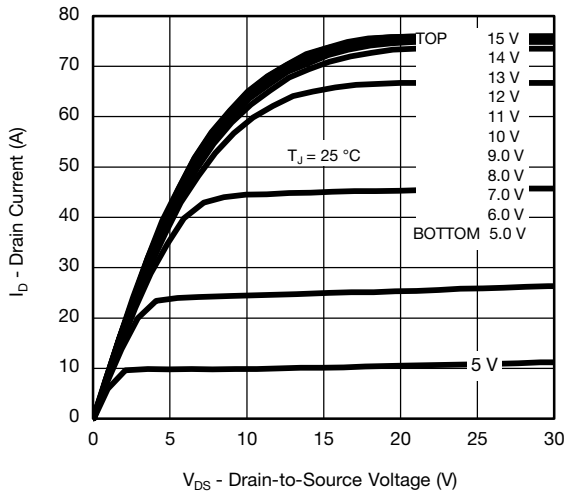

Fig. 1 - Typical Output Characteristics, $T_C = 25\text{ }^\circ\text{C}$

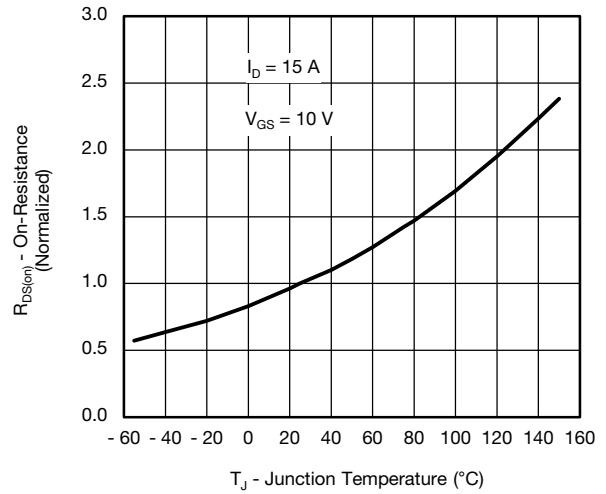

Fig. 4 - Normalized On-Resistance vs. Temperature

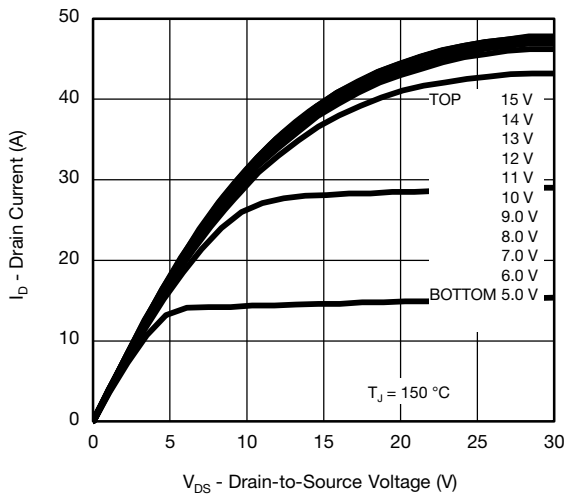

Fig. 2 - Typical Output Characteristics, $T_C = 150\text{ }^\circ\text{C}$

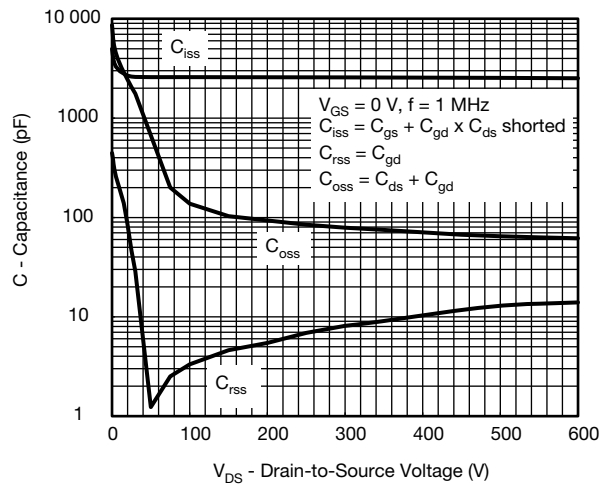

Fig. 5 - Typical Capacitance vs. Drain-to-Source Voltage

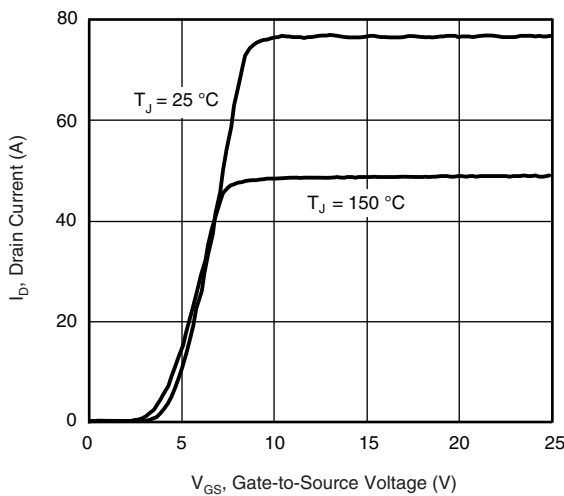

Fig. 3 - Typical Transfer Characteristics

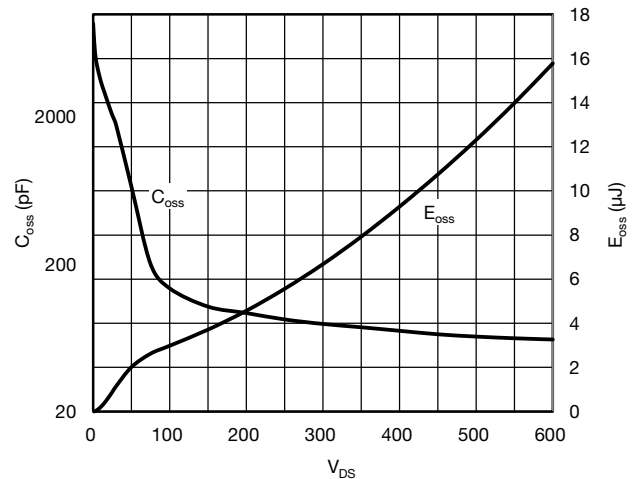

Fig. 6 - C_{oss} and E_{oss} vs. V_{DS}

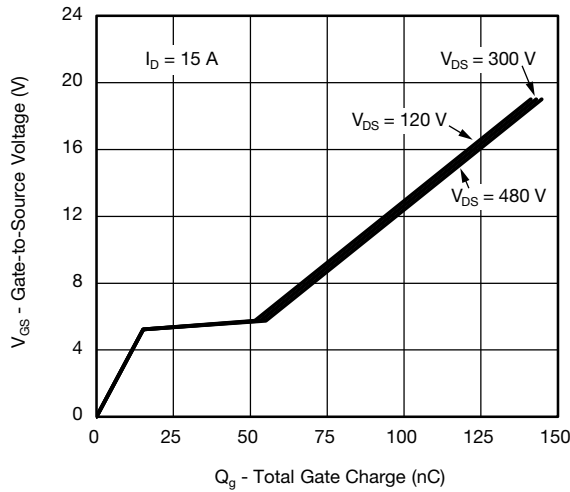

Fig. 7 - Typical Gate Charge vs. Gate-to-Source Voltage

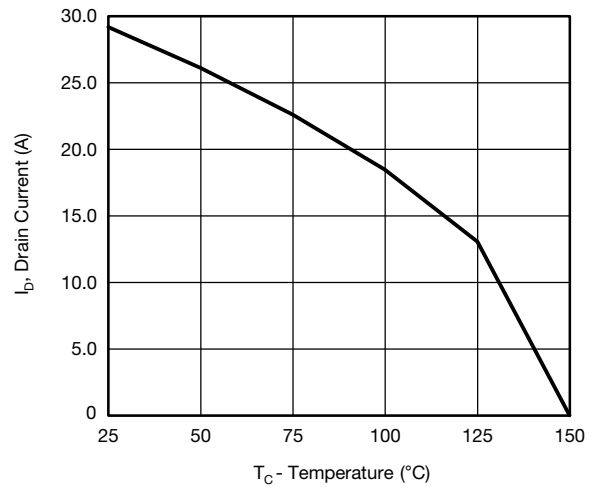

Fig. 10 - Maximum Drain Current vs. Case Temperature

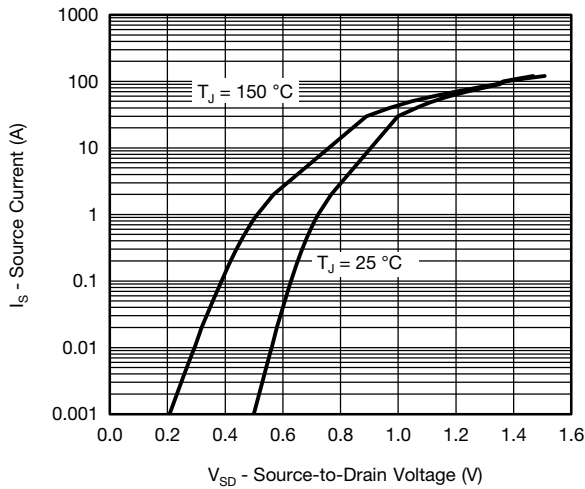

Fig. 8 - Typical Source-Drain Diode Forward Voltage

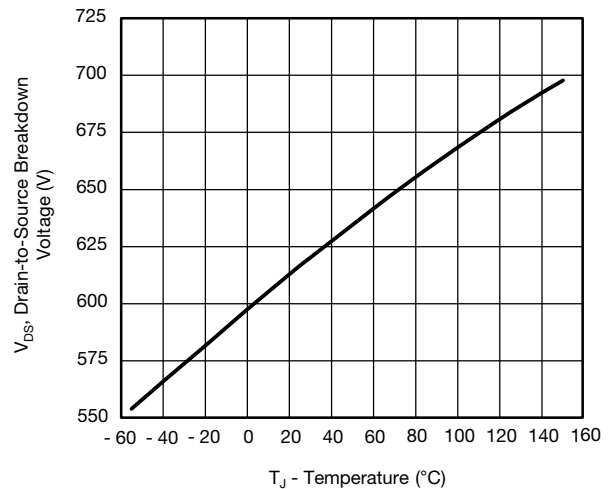

Fig. 11 - Temperature vs. Drain-to-Source Voltage

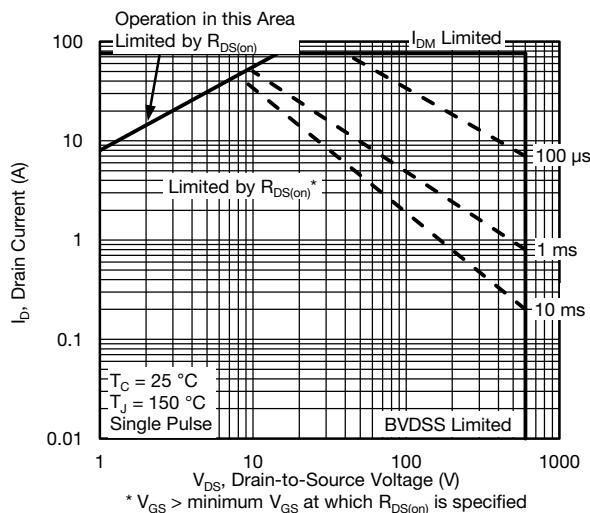

Fig. 9 - Maximum Safe Operating Area

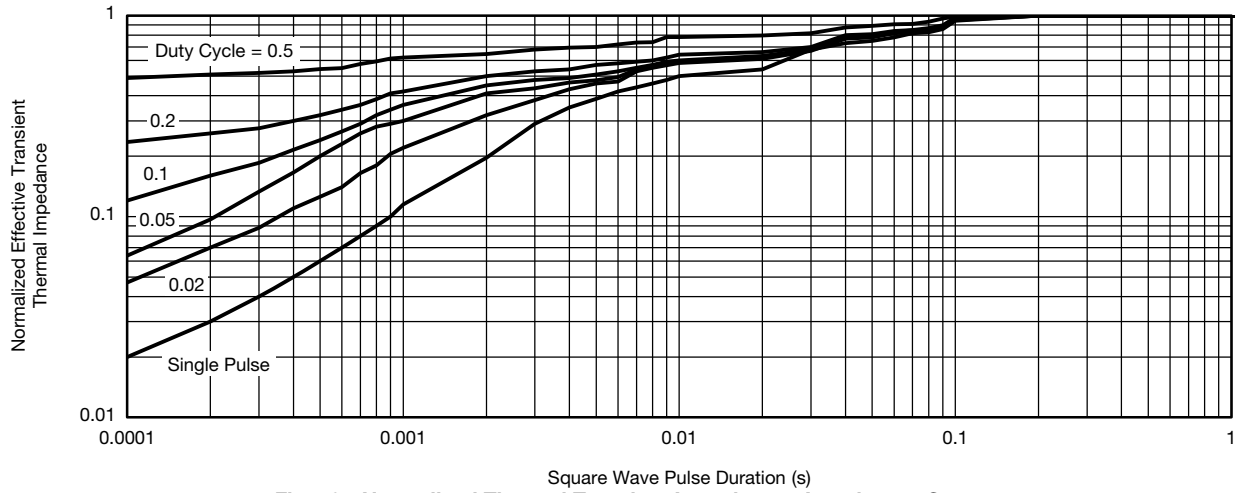

Fig. 12 - Normalized Thermal Transient Impedance, Junction-to-Case

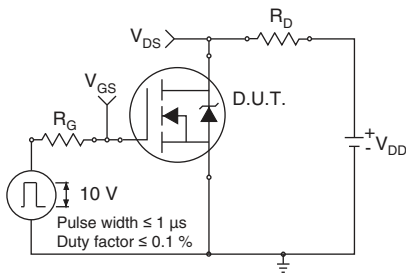

Fig. 13 - Switching Time Test Circuit

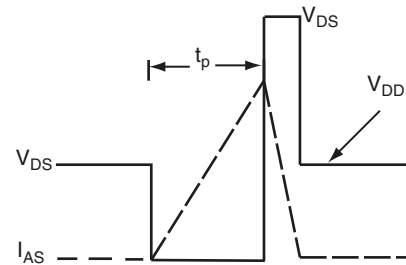

Fig. 16 - Unclamped Inductive Waveforms

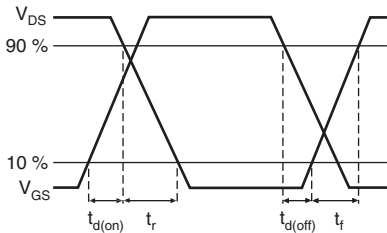

Fig. 14 - Switching Time Waveforms

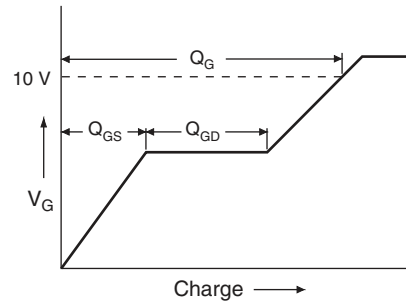

Fig. 17 - Basic Gate Charge Waveform

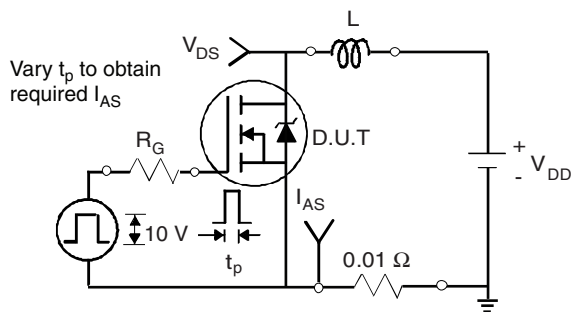

Fig. 15 - Unclamped Inductive Test Circuit

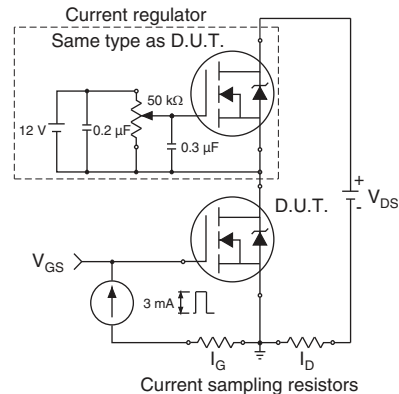

Fig. 18 - Gate Charge Test Circuit



Note

a. $V_{GS} = 5 V$ for logic level devices

Fig. 19 - For N-Channel

Vishay Siliconix maintains worldwide manufacturing capability. Products may be manufactured at one of several qualified locations. Reliability data for Silicon Technology and Package Reliability represent a composite of all qualified locations. For related documents such as package/tape drawings, part marking, and reliability data, see www.vishay.com/ppg?91454.

TO-220 FULLPAK (HIGH VOLTAGE)

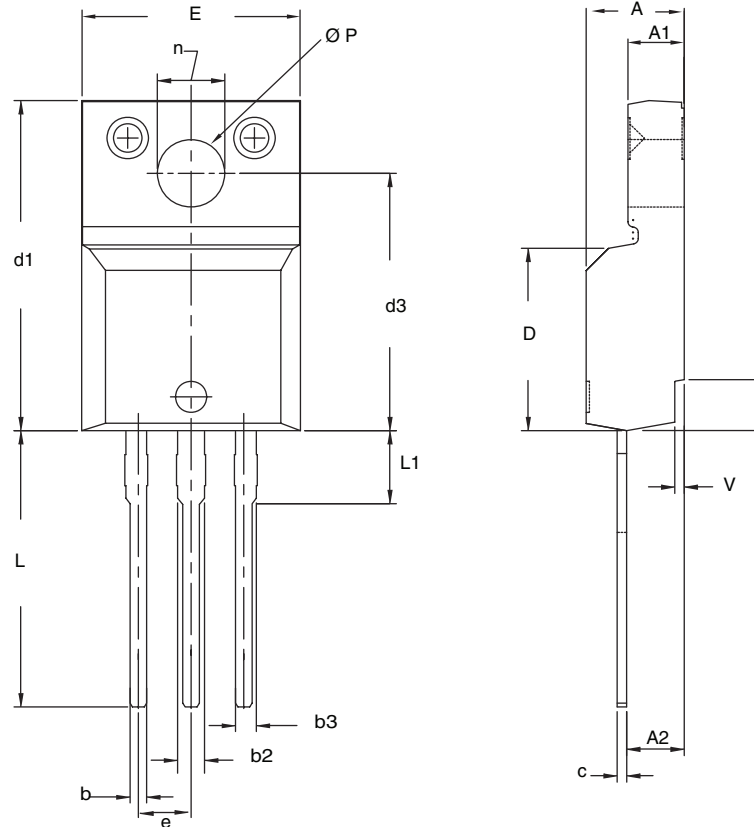

DIM.	MILLIMETERS		INCHES	
	MIN.	MAX.	MIN.	MAX.
A	4.570	4.830	0.180	0.190
A1	2.570	2.830	0.101	0.111
A2	2.510	2.850	0.099	0.112
b	0.622	0.890	0.024	0.035
b2	1.229	1.400	0.048	0.055
b3	1.229	1.400	0.048	0.055
c	0.440	0.629	0.017	0.025
D	8.650	9.800	0.341	0.386
d1	15.88	16.120	0.622	0.635
d3	12.300	12.920	0.484	0.509
E	10.360	10.630	0.408	0.419
e	2.54 BSC		0.100 BSC	
L	13.200	13.730	0.520	0.541
L1	3.100	3.500	0.122	0.138
n	6.050	6.150	0.238	0.242
Ø P	3.050	3.450	0.120	0.136
u	2.400	2.500	0.094	0.098
v	0.400	0.500	0.016	0.020

ECN: X09-0126-Rev. B, 26-Oct-09
 DWG: 5972

Notes

1. To be used only for process drawing.
2. These dimensions apply to all TO-220, FULLPAK leadframe versions 3 leads.
3. All critical dimensions should C meet $C_{pk} > 1.33$.
4. All dimensions include burrs and plating thickness.
5. No chipping or package damage.



Disclaimer

ALL PRODUCT, PRODUCT SPECIFICATIONS AND DATA ARE SUBJECT TO CHANGE WITHOUT NOTICE TO IMPROVE RELIABILITY, FUNCTION OR DESIGN OR OTHERWISE.

Vishay Intertechnology, Inc., its affiliates, agents, and employees, and all persons acting on its or their behalf (collectively, "Vishay"), disclaim any and all liability for any errors, inaccuracies or incompleteness contained in any datasheet or in any other disclosure relating to any product.

Vishay makes no warranty, representation or guarantee regarding the suitability of the products for any particular purpose or the continuing production of any product. To the maximum extent permitted by applicable law, Vishay disclaims (i) any and all liability arising out of the application or use of any product, (ii) any and all liability, including without limitation special, consequential or incidental damages, and (iii) any and all implied warranties, including warranties of fitness for particular purpose, non-infringement and merchantability.

Statements regarding the suitability of products for certain types of applications are based on Vishay's knowledge of typical requirements that are often placed on Vishay products in generic applications. Such statements are not binding statements about the suitability of products for a particular application. It is the customer's responsibility to validate that a particular product with the properties described in the product specification is suitable for use in a particular application. Parameters provided in datasheets and / or specifications may vary in different applications and performance may vary over time. All operating parameters, including typical parameters, must be validated for each customer application by the customer's technical experts. Product specifications do not expand or otherwise modify Vishay's terms and conditions of purchase, including but not limited to the warranty expressed therein.

Except as expressly indicated in writing, Vishay products are not designed for use in medical, life-saving, or life-sustaining applications or for any other application in which the failure of the Vishay product could result in personal injury or death. Customers using or selling Vishay products not expressly indicated for use in such applications do so at their own risk. Please contact authorized Vishay personnel to obtain written terms and conditions regarding products designed for such applications.

No license, express or implied, by estoppel or otherwise, to any intellectual property rights is granted by this document or by any conduct of Vishay. Product names and markings noted herein may be trademarks of their respective owners.

Mouser Electronics

Authorized Distributor

Click to View Pricing, Inventory, Delivery & Lifecycle Information:

Vishay:

[SIHF30N60E-E3](#) [SIHF30N60E-GE3](#)