

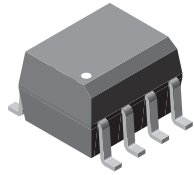

# Optocoupler, Photodarlington Output, Low Input Current, High Gain, with Base Connection

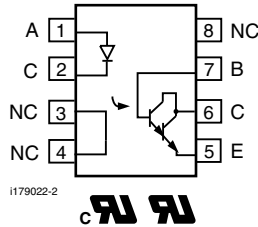

i179074



### FEATURES

- Isolation test voltage, 4000 V<sub>RMS</sub>
- Material categorization:  
For definitions of compliance please see [www.vishay.com/doc?99912](http://www.vishay.com/doc?99912)



RoHS COMPLIANT

### AGENCY APPROVALS

- UL1577, file no. E52744 system code Y
- cUL - file no. E52744, equivalent to CSA bulletin 5A
- DIN EN 60747-5-5 (VDE 0884-5) approved, contact customer service if this option is required

### DESCRIPTION

The VO221AT, VO222AT, VO223AT are high current transfer ratio (CTR) optocouplers with a gallium arsenide infrared LED emitter and a silicon NPN photodarlington transistor detector.

The device has a CTR tested at 1 mA LED current. This low drive current permits easy interfacing from CMOS to LSTTL or TTL.

### ORDERING INFORMATION

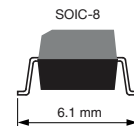
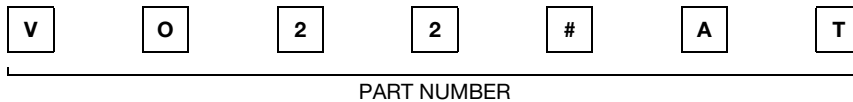

AGENCY CERTIFIED/PACKAGE	CTR (%)		
UL, cUL	≥ 100	≥ 200	≥ 500
SOIC-8	VO221AT	VO222AT	VO223AT

### ABSOLUTE MAXIMUM RATINGS (T<sub>amb</sub> = 25 °C, unless otherwise specified)

PARAMETER	TEST CONDITION	SYMBOL	VALUE	UNIT
<b>INPUT</b>				
Peak reverse voltage		V <sub>R</sub>	6	V
Peak forward current	1 μs, 300 pps	I <sub>FM</sub>	1	A
Forward continuous current		I <sub>F</sub>	60	mA
Power dissipation		P <sub>diss</sub>	90	mW
Derate linearly from 25 °C			1.2	mW/°C
<b>OUTPUT</b>				
Collector emitter breakdown voltage		BV <sub>CEO</sub>	30	V
Emitter collector breakdown voltage		BV <sub>ECO</sub>	5	V
Collector base breakdown voltage		BV <sub>CBO</sub>	70	V
I <sub>Cmax, DC</sub>		I <sub>Cmax, DC</sub>	50	mA
I <sub>Cmax</sub>	t < 1 ms	I <sub>Cmax</sub>	100	mA
Power dissipation		P <sub>diss</sub>	150	mW

**ABSOLUTE MAXIMUM RATINGS** ( $T_{amb} = 25\text{ }^{\circ}\text{C}$ , unless otherwise specified)

PARAMETER	TEST CONDITION	SYMBOL	VALUE	UNIT
<b>COUPLER</b>				
Derate linearly from 25 °C			2	mW/°C
Isolation test voltage	$t = 1\text{ s}$	$V_{ISO}$	4000	$V_{RMS}$
Total package dissipation (at 25 °C ambient) (LED and detector)		$P_{tot}$	240	mW
Derate linearly from 25 °C			3.2	mW/°C
Storage temperature		$T_{stg}$	- 40 to + 150	°C
Operating temperature		$T_{amb}$	- 40 to + 100	°C
Soldering time at 260 °C		$T_{sld}$	10	s

**Note**

- Stresses in excess of the absolute maximum ratings can cause permanent damage to the device. Functional operation of the device is not implied at these or any other conditions in excess of those given in the operational sections of this document. Exposure to absolute maximum ratings for extended periods of the time can adversely affect reliability.

**ELECTRICAL CHARACTERISTICS** ( $T_{amb} = 25\text{ }^{\circ}\text{C}$ , unless otherwise specified)

PARAMETER	TEST CONDITION	SYMBOL	MIN.	TYP.	MAX.	UNIT
<b>INPUT</b>						
Forward voltage	$I_F = 1\text{ mA}$	$V_F$		1	1.5	V
Reverse current	$V_R = 6\text{ V}$	$I_R$		0.1	100	$\mu\text{A}$
Capacitance	$V_R = 0\text{ V}$ , $f = 1\text{ MHz}$	$C_O$		25		pF
<b>OUTPUT</b>						
Collector emitter breakdown voltage	$I_C = 100\text{ }\mu\text{A}$	$BV_{CEO}$	30			V
Emitter collector breakdown voltage	$I_C = 10\text{ }\mu\text{A}$	$BV_{ECO}$	5			V
Collector base breakdown voltage	$I_C = 10\text{ }\mu\text{A}$	$BV_{CBO}$	70			V
Collector emitter leakage current	$V_{CE} = 20\text{ V}$	$I_{CEO}$			40	nA
Collector base current		$I_{CBO}$			1	nA
Emitter base current		$I_{EBO}$			1	nA
Collector emitter capacitance	$V_{CE} = 10\text{ V}$	$C_{CE}$		3.4		pF
Saturation voltage, collector emitter	$I_{CE} = 0.5\text{ mA}$	$V_{CEsat}$			1	V
<b>COUPLER</b>						
Capacitance (input to output)		$C_{IO}$		0.5		pF

**Note**

- Minimum and maximum values are tested requirements. Typical values are characteristics of the device and are the result of engineering evaluations. Typical values are for information only and are not part of the testing requirements.

**CURRENT TRANSFER RATIO** ( $T_{amb} = 25\text{ }^{\circ}\text{C}$ , unless otherwise specified)

PARAMETER	TEST CONDITION	PART	SYMBOL	MIN.	TYP.	MAX.	UNIT
$I_C/I_F$	$I_F = 1\text{ mA}$ , $V_{CE} = 5\text{ V}$	VO221AT	$CTR_{DC}$	100			%
		VO222AT	$CTR_{DC}$	200			%
		VO223AT	$CTR_{DC}$	500			%

**SWITCHING CHARACTERISTICS** ( $T_{amb} = 25\text{ }^{\circ}\text{C}$ , unless otherwise specified)

PARAMETER	TEST CONDITION	SYMBOL	MIN.	TYP.	MAX.	UNIT
Turn-on time	$V_{CC} = 10\text{ V}$ , $R_L = 100\ \Omega$ , $I_F = 5\text{ mA}$	$t_{on}$		3		$\mu\text{s}$
Turn-off time	$V_{CC} = 10\text{ V}$ , $R_L = 100\ \Omega$ , $I_F = 5\text{ mA}$	$t_{off}$		3		$\mu\text{s}$

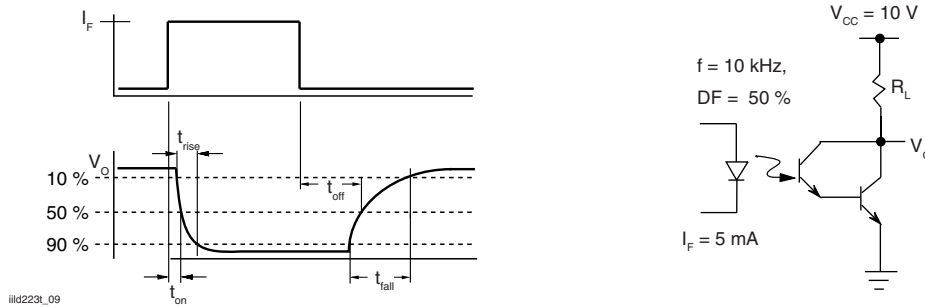

Fig. 1 - Switching Test Circuit

**SAFETY AND INSULATION RATINGS**

PARAMETER	TEST CONDITION	SYMBOL	MIN.	TYP.	MAX.	UNIT
Climatic classification	according to IEC 68 part 1			40/100/21		
Polution degree				2		
Comparative tracking index		CTI	175		399	
Isolation test voltage	1 s	$V_{ISO}$	4000			$V_{RMS}$
Peak transient overvoltage		$V_{IOTM}$	6000			V
Peak insulation voltage		$V_{IORM}$	560			V
Resistance (input to output)		$R_{IO}$		$10^{11}$		$\Omega$
Safety rating - power output		$P_{SO}$			350	mW
Safety rating - input current		$I_{SI}$			150	mA
Safety rating - temperature		$T_{SI}$			165	$^{\circ}\text{C}$
External creepage distance			4			mm
External clearance distance			4			mm
Internal creepage distance			3.3			mm
Insulation thickness			0.2			mm

**Note**

- As per IEC 60747-5-2, § 7.4.3.8.1, this optocoupler is suitable for "safe electrical insulation" only within the safety ratings. Compliance with the safety ratings shall be ensured by means of protective circuits.

**TYPICAL CHARACTERISTICS** ( $T_{amb} = 25\text{ }^{\circ}\text{C}$ , unless otherwise specified)

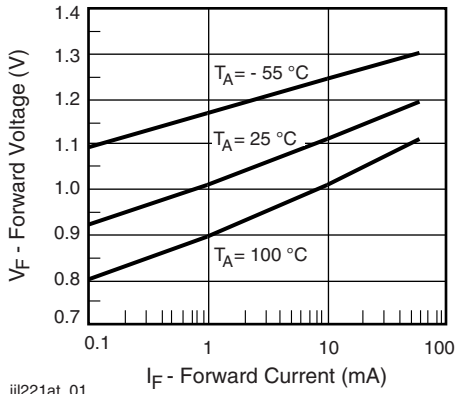

iii221at\_01

Fig. 2 - Forward Voltage vs. Forward Current

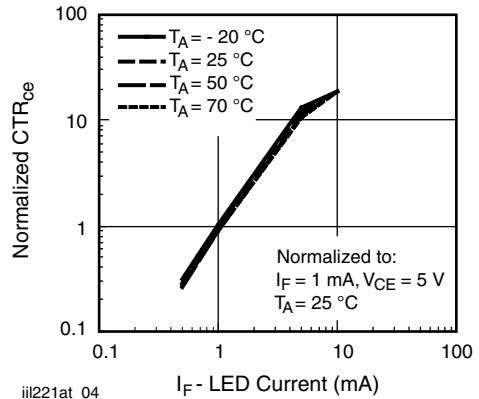

iii221at\_04

Fig. 5 - Normalized  $CTR_{CE}$  vs. LED Current

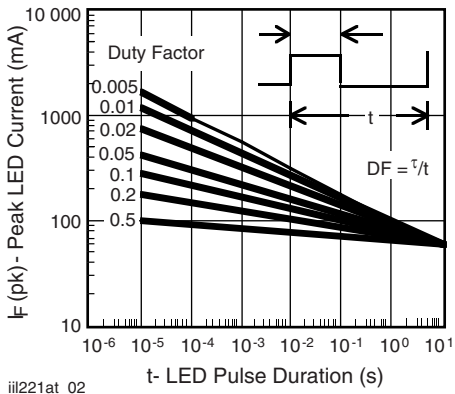

iii221at\_02

Fig. 3 - Peak LED Current vs. Duty Factor,  $\tau$

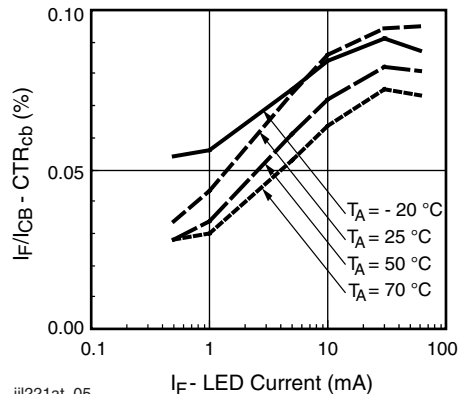

iii221at\_05

Fig. 6 -  $CTR_{CB}$  vs. LED Current

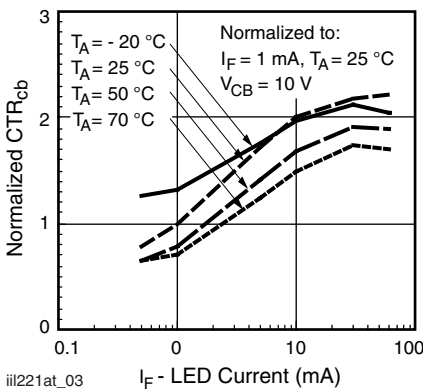

iii221at\_03

Fig. 4 - Normalized  $CTR_{cb}$  vs.  $I_F$

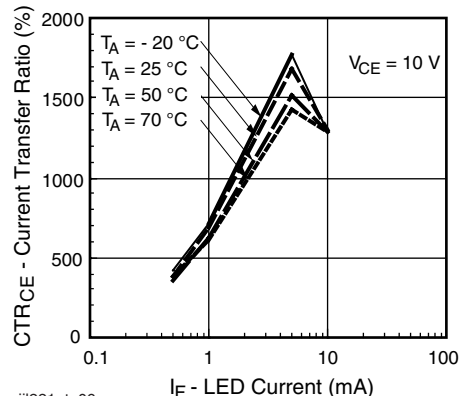

iii221at\_06

Fig. 7 - CTR vs. LED Current

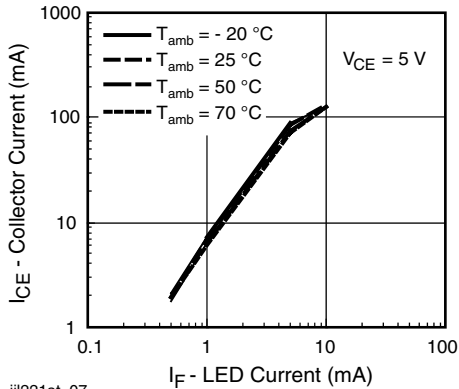

iii221at\_07

Fig. 8 - Collector Current vs. LED Current

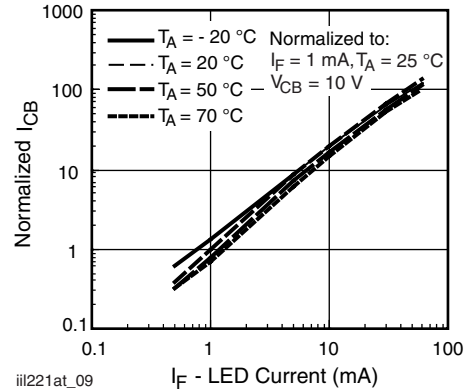

iii221at\_09

Fig. 10 - Normalized  $I_{CB}$  vs.  $I_F$

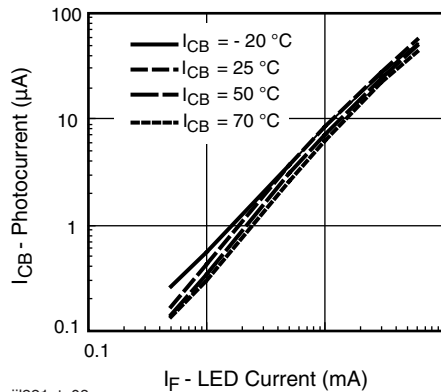

iii221at\_08

Fig. 9 - Photocurrent vs. LED Current

**PACKAGE DIMENSIONS** in millimeters

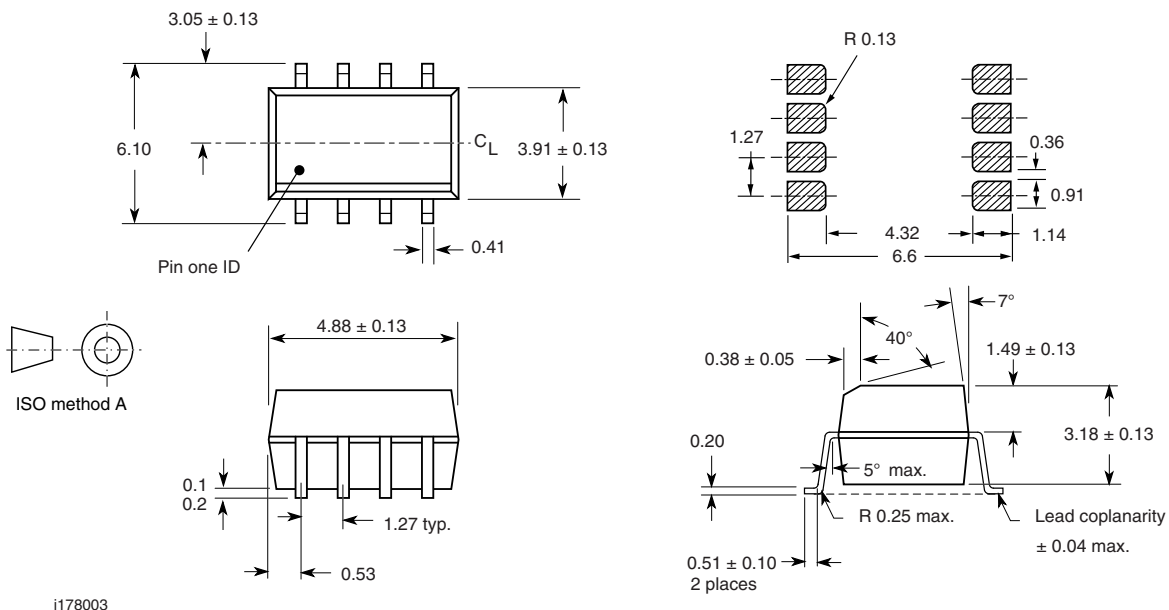

i178003

**PACKAGE MARKING** (example)

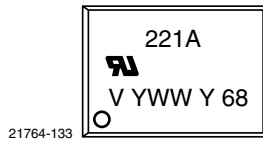

**TAPE AND REEL PACKAGING**

Dimensions in millimeters

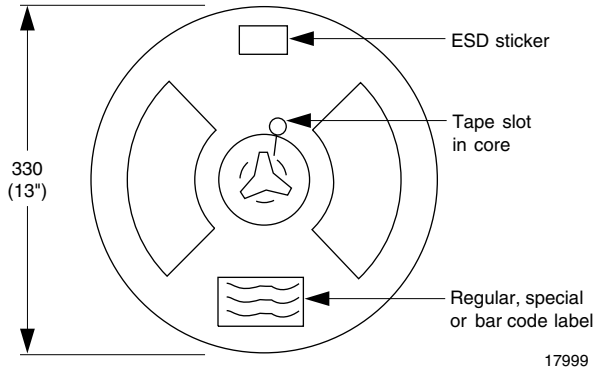

Fig. 11 - Tape and Reel Shipping Medium (EIA-481, revision A, and IEC 60286), 2000 units per reel

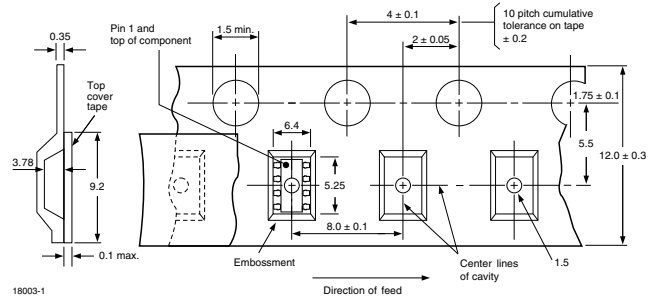

Fig. 12 - Tape Dimensions, 2000 Parts per Reel



## **Disclaimer**

ALL PRODUCT, PRODUCT SPECIFICATIONS AND DATA ARE SUBJECT TO CHANGE WITHOUT NOTICE TO IMPROVE RELIABILITY, FUNCTION OR DESIGN OR OTHERWISE.

Vishay Intertechnology, Inc., its affiliates, agents, and employees, and all persons acting on its or their behalf (collectively, "Vishay"), disclaim any and all liability for any errors, inaccuracies or incompleteness contained in any datasheet or in any other disclosure relating to any product.

Vishay makes no warranty, representation or guarantee regarding the suitability of the products for any particular purpose or the continuing production of any product. To the maximum extent permitted by applicable law, Vishay disclaims (i) any and all liability arising out of the application or use of any product, (ii) any and all liability, including without limitation special, consequential or incidental damages, and (iii) any and all implied warranties, including warranties of fitness for particular purpose, non-infringement and merchantability.

Statements regarding the suitability of products for certain types of applications are based on Vishay's knowledge of typical requirements that are often placed on Vishay products in generic applications. Such statements are not binding statements about the suitability of products for a particular application. It is the customer's responsibility to validate that a particular product with the properties described in the product specification is suitable for use in a particular application. Parameters provided in datasheets and / or specifications may vary in different applications and performance may vary over time. All operating parameters, including typical parameters, must be validated for each customer application by the customer's technical experts. Product specifications do not expand or otherwise modify Vishay's terms and conditions of purchase, including but not limited to the warranty expressed therein.

Except as expressly indicated in writing, Vishay products are not designed for use in medical, life-saving, or life-sustaining applications or for any other application in which the failure of the Vishay product could result in personal injury or death. Customers using or selling Vishay products not expressly indicated for use in such applications do so at their own risk. Please contact authorized Vishay personnel to obtain written terms and conditions regarding products designed for such applications.

No license, express or implied, by estoppel or otherwise, to any intellectual property rights is granted by this document or by any conduct of Vishay. Product names and markings noted herein may be trademarks of their respective owners.

# Mouser Electronics

Authorized Distributor

Click to View Pricing, Inventory, Delivery & Lifecycle Information:

Vishay:

[VO223AT](#) [VO222AT](#) [VO221AT](#)