

FEATURES

1. This specification shall be applied to photocoupler. Model No. MOC3052 as an option.

2. Applicable Models (Business dealing name)

* Dual-in-line package :

MOC3052-V : 1-channel type

* Wide lead spacing package :

MOC3052M-V : 1-channel type

* Surface mounting package :

MOC3052S-V : 1-channel type

* Tape and reel packaging :

MOC3052S TA1-V

3. The relevant models are the models Approved by VDE according to DIN VDE 0884:1992-06

Approved Model No.: MOC3052 / MOC3052M / MOC3052S /

VDE approved No.: 094722

(According to the specification DIN VDE 0884:1992-06)

* Operating isolation voltage V_{IORM} : 850V (Peak)

* Transient voltage V_{TR} : 6000V (Peak)

* Pollution : 2 (According to VDE 0110-1 : 1997-04)

* Clearances distance (Between input and output) : 7.0mm (MIN.)

* Creepage distance (Between input and output) : 7.0mm (MIN.)

* Isolation thickness between input and output : 0.4mm (MIN.)

* Safety limit values Current (Isi) : 400mA (Diode side)

Power (Psi) : 700mW (Phototransistor side)

Temperature(Tsi) : 175°C

In order to keep safety electric isolation of photocoupler, please set the protective circuit to keep within safety limit values when the actual application equipment troubled.

* Indication of VDE 0884 approval prints "  " on sleeve package.

OUTLINE DIMENSIONS

Dual-in-line package :

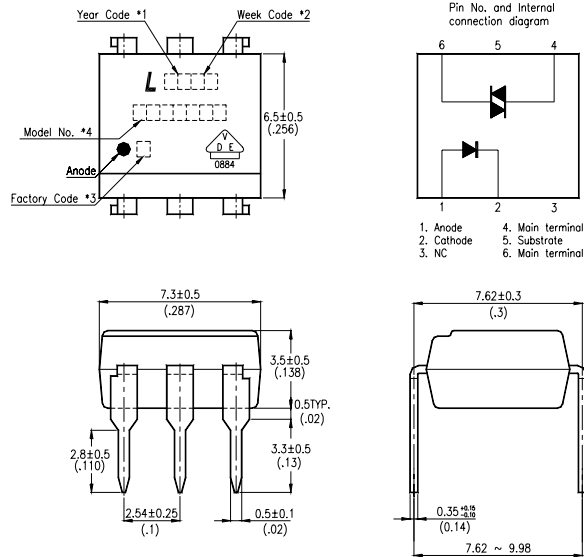

Wide lead spacing package:

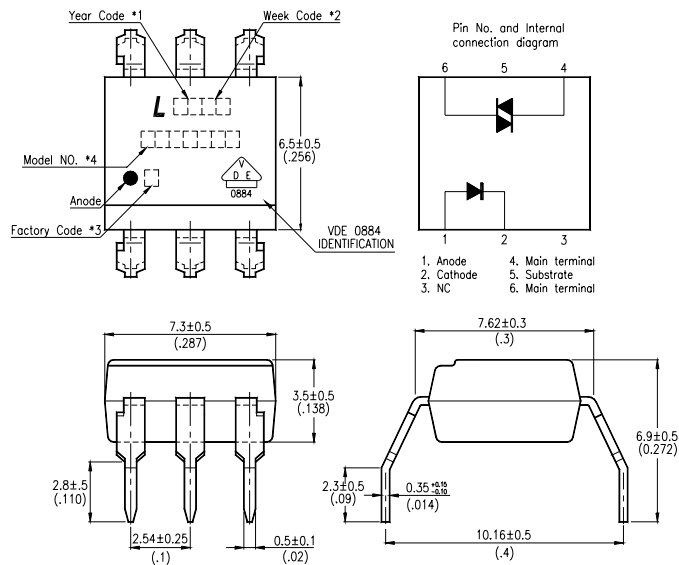

- *1. Year date code.
- *2. 2-digit work week.
- *3. Factory identification mark shall be marked (Z : Taiwan, Y : Thailand, X : China).
- *4. Model No.: MOC3052

OUTLINE DIMENSIONS

Surface mounting package :

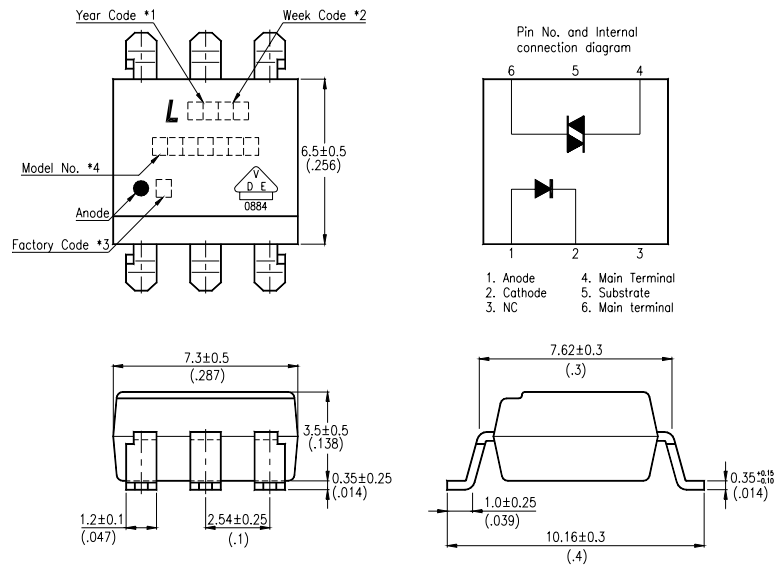

- *1. Year date code.
- *2. 2-digit work week.
- *3. Factory identification mark shall be marked (Z : Taiwan, Y : Thailand, X : China).
- *4. Model No.: MOC3052

TAPING DIMENSIONS

Tape and reel package (TYPE I):
MOC3052S-TA1

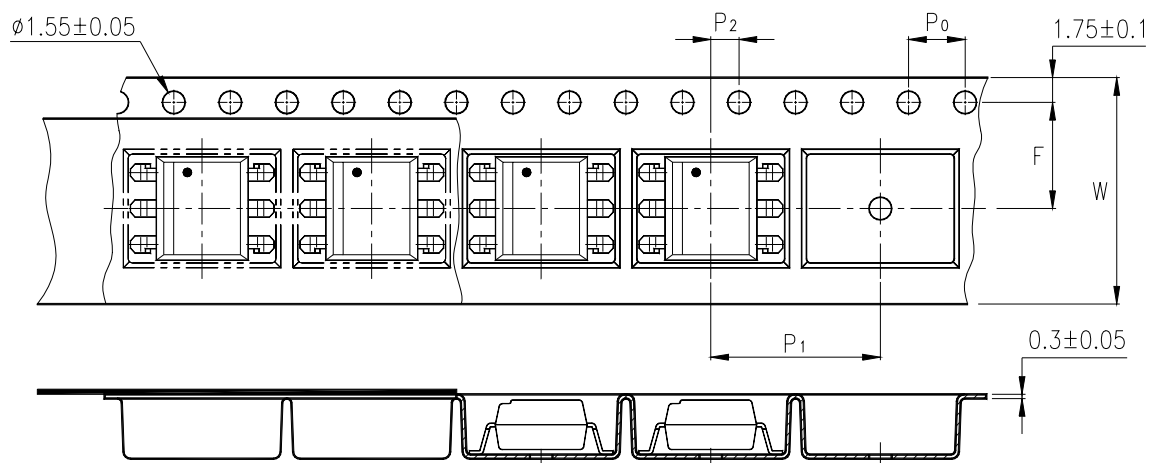

Description	Symbol	Dimensions in mm (inches)
Tape wide	W	16 ± 0.3 (.63)
Pitch of sprocket holes	P_0	4 ± 0.1 (.15)
Distance of compartment	F	7.5 ± 0.1 (.295)
Distance of compartment to compartment	P_2	2 ± 0.1 (.079)
Distance of compartment to compartment	P_1	12 ± 0.1 (.472)

ABSOLUTE MAXIMUM RATING

(Ta = 25°C)

PARAMETER		SYMBOL	RATING	UNIT
INPUT	Forward Current	I _F	50	mA
	Reverse Voltage	V _R	6	V
	Power Dissipation	P _D	100	mW
OUTPUT	Off-State Output Terminal Voltage	V _{DRM}	600	V
	Peak Repetitive Surge Current (PW=100μs, 120pps)	I _{TSM}	1	A
	Collector Power Dissipation	P _C	300	mW
Total Power Dissipation		P _{tot}	330	mW
*1	Isolation Voltage	V _{iso}	5,000	V _{rms}
Ambient Operating Temperature Range		T _A	-40 ~ +100	°C
Storage Temperature Range		T _{stg}	-55 ~ +150	°C
*2	Soldering Temperature	T _L	260	°C

*1. AC For 1 Minute, R.H. = 40 ~ 60%

Isolation voltage shall be measured using the following method.

- (1) Short between anode and cathode on the primary side and between collector, emitter on the secondary side.
- (2) The isolation voltage tester with random-phase circuit shall be used.
- (3) The waveform of applied voltage shall be a sine wave.

*2. For 10 Seconds

ELECTRICAL - OPTICAL CHARACTERISTICS

(Ta = 25°C)

PARAMETER		SYMBOL	MIN.	TYP.	MAX.	UNIT	CONDITIONS
INPUT	Forward Voltage	V_F	—	1.2	1.4	V	$I_F=20\text{mA}$
	Reverse Current	I_R	—	0.05	10	μA	$V_R=6\text{V}$
OUTPUT	*1 Peak Blocking Current, Either Direction	I_{DRM}	—	—	100	nA	$V_{\text{DRM}} = 600\text{V}$
	Peak On-State Voltage, Either Direction	V_{TM}	—	—	3.0	V	$I_{\text{TM}}=100\text{ mA Peak}$
	*2 Critical rate of Rise of Off-State Voltage	dv/dt	1000	—	—	V/ μs	
	Turn-On Time	T_{ON}	—	80	200	μs	$V_P=9\text{V}, I_F=20\text{mA}$ $R_L = 100\Omega$
COUPLED	*3 Led Trigger Current, Current Required to Latch Output, Either Direction	MOC3052 I_{FT}	—	—	10	mA	Main Terminal Voltage = 3V
	Holding Current, Either Direction	I_H	—	400	—	μA	

*1 Test voltage must be applied within dv/dt rating.

*2 This is static dv/dt. Commutating dv/dt is a function of the load-driving thyristor(s) only.

*3 All devices are guaranteed to trigger at an I_F value less than or equal to max I_{FT} . Therefore, recommended operating I_F lies between max 10mA for MOC3052 and absolute max I_F (50mA)

CHARACTERISTICS CURVES

Fig.1 Forward Current vs. Ambient Temperature

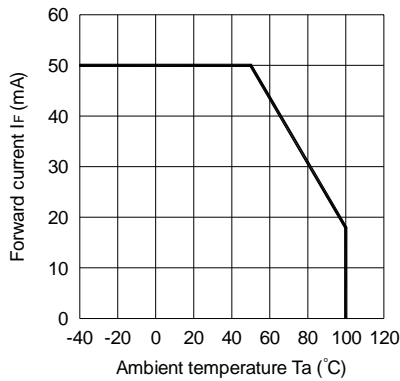

Fig.2 On-state Current vs. Ambient Temperature

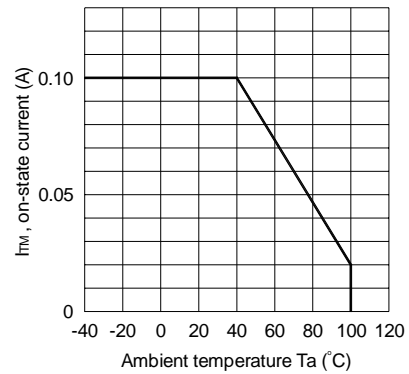

Fig.3 Minimum Trigger Current vs. Ambient Temperature

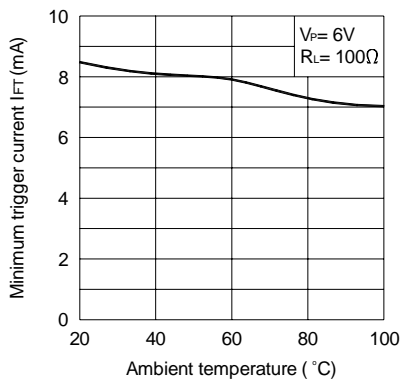

Fig.4 Forward Current vs. Forward Voltage

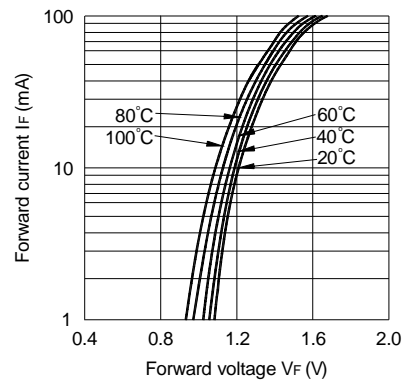

Fig.5 On-state Voltage vs. Ambient Temperature

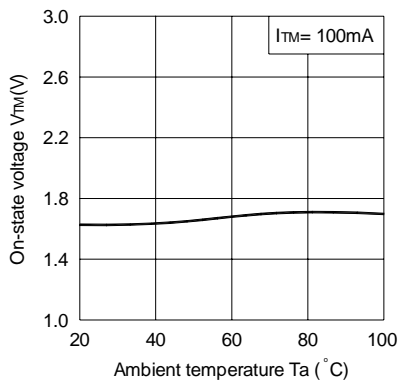
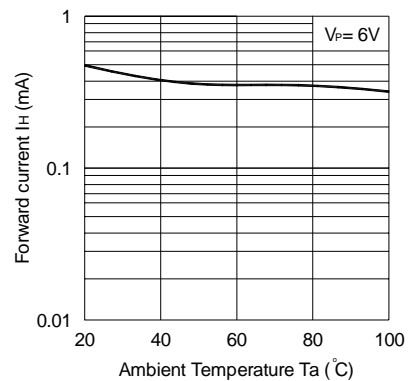

Fig.6 Holding Current vs. Ambient Temperature



CHARACTERISTICS CURVES

Fig.7 Turn-on Time vs. Forward Current

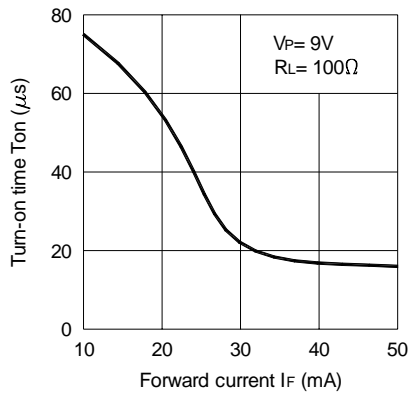

Fig.8 Repetitive Peak Off-state Current vs. Temperature

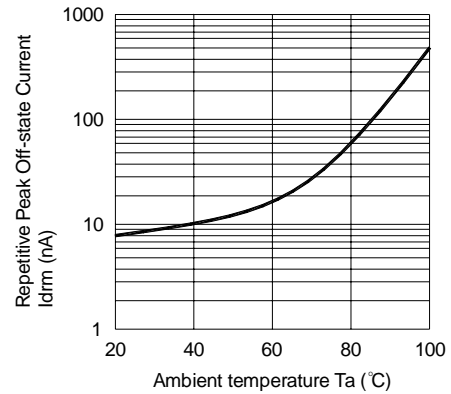
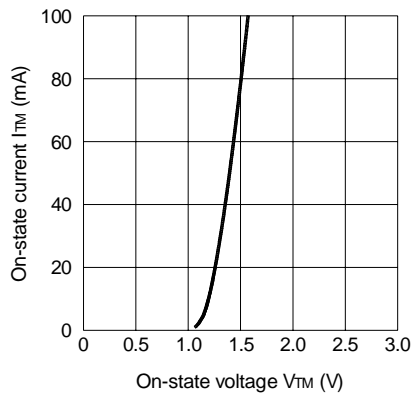
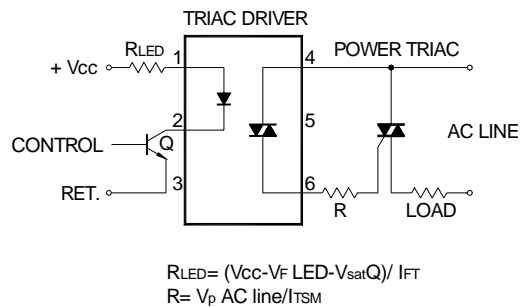

Fig.9 On-state Current vs. On-state Voltage



Basic Driver Circuit



RECOMMENDED FOOT PRINT PATTERNS (MOUNT PAD)

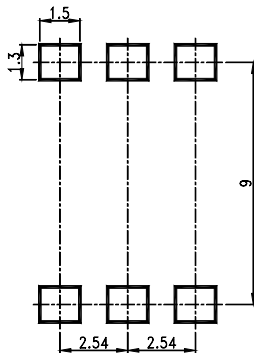

Unit : mm